

TECHNICAL RULES



**Western Power
363 Wellington Street
Perth Western Australia 6000
GPO Box L921 Perth WA 6001**

Draft dated 24 March 2007

IMPORTANT NOTE: This document is subject to amendment (amendments must be made in accordance with the *Electricity Networks Access Code 2004*). The latest version of this document can be obtained from Western Power and is available for downloading from, Western Power's internet site: <http://www.westernpower.com.au>

This page has been left blank intentionally.

PREFACE

The Electricity Networks Corporation, trading as Western Power, was established on 1 April 2006 by the Electricity Corporations Act (2005) (WA).

Western Power is required to provide open access to capacity in its electricity *transmission and distribution systems*. The principal objective of open access is to facilitate competition in the energy industry by allowing independent *Generators* to *supply associated loads* by utilising Western Power's networks. The Electricity Networks Access Code 2004 (WA) (the "*Access Code*"), which superseded the initial regulations, covers *transmission and distribution systems*. Chapter 12 of the *Access Code* requires Western Power to publish *Technical Rules* (the "*Rules*"). In addition, section A6.1(m) requires Western Power to publish *transmission system planning criteria*.

These *Rules* cover the *South West Interconnected Network* ("*SWIN*"), and detail the technical requirements to be met by Western Power on the *transmission and distribution systems* and by *Users* who connect *facilities* to the *transmission and distribution systems*. In addition, the planning criteria to be applied to the *transmission and distribution systems* are contained within these *Rules*. Prospective *Users* or existing *Users* who wish to connect *facilities* to the *transmission and distribution systems* must first submit an *access application* to Western Power in accordance with the *Access Code*.

As this document is subject to amendment, people referring to this document are advised to consult the Manager the Network Services Provider Strategy and Regulation, Western Power Corporation, at the address below, to ensure that they have the latest version.

Western Power
GPO Box L921
PERTH WA 6001

Telephone: (08) 9326 6687

Facsimile: (08) 9326 6550

The document can also be examined and downloaded at Western Power's internet site:
<http://www.westernpower.com.au>

It is important to note that amendments to this document, and variations and exemptions to *Rules* requirements granted to *Users*, can only be made in accordance with the *Access Code*.

This page has been left blank intentionally.

TECHNICAL RULES FOR THE SOUTH WEST INTERCONNECTED NETWORK

TABLE OF CONTENTS

1.	GENERAL.....	12
1.1	INTRODUCTION.....	12
1.2	AUTHORISATION.....	12
1.3	APPLICATION.....	2
1.4	COMMENCEMENT.....	32
1.5	INTERPRETATION.....	32
1.6	THE <i>NETWORK SERVICE PROVIDER</i> AND <i>USERS</i> TO ACT REASONABLY.....	32
1.7	DISPUTE RESOLUTION.....	32
1.8	OBLIGATIONS.....	32
1.9	VARIATIONS AND <i>EXEMPTIONS</i> FROM THE RULES.....	52
2.	TRANSMISSION AND DISTRIBUTION SYSTEM PERFORMANCE AND PLANNING CRITERIA.....	72
2.1	INTRODUCTION.....	72
2.2	POWER SYSTEM PERFORMANCE STANDARDS.....	72
2.3	OBLIGATIONS OF NETWORK SERVICE PROVIDER IN RELATION TO POWER SYSTEM PERFORMANCE.....	162
2.4	<i>LOAD SHEDDING FACILITIES</i>	232
2.5	<i>TRANSMISSION AND DISTRIBUTION SYSTEM</i> PLANNING CRITERIA.....	232
2.6	DISTRIBUTION DESIGN CRITERIA.....	312
2.7	<i>TRANSMISSION AND DISTRIBUTION SYSTEM</i> DESIGN AND CONSTRUCTION STANDARDS.....	312
2.8	<i>DISTRIBUTION</i> CONDUCTOR OR CABLE SELECTION.....	312
2.9	<i>TRANSMISSION AND DISTRIBUTION SYSTEM</i> PROTECTION.....	322
3.	TECHNICAL REQUIREMENTS OF USER FACILITIES.....	382
3.1	INTRODUCTION.....	382
3.2	REQUIREMENTS FOR ALL <i>USERS</i>	382
3.3	REQUIREMENTS FOR <i>CONNECTION</i> OF GENERATING UNITS.....	412
3.4	REQUIREMENTS FOR <i>CONNECTION</i> OF <i>LOADS</i>	652
3.5	<i>USER'S PROTECTION</i> REQUIREMENTS.....	712
3.6	REQUIREMENTS FOR <i>CONNECTION</i> OF SMALL <i>GENERATING UNITS</i> TO THE <i>DISTRIBUTION</i> NETWORK.....	742
3.7	REQUIREMENTS FOR CONNECTION OF ENERGY SYSTEMS TO THE LOW VOLTAGE DISTRIBUTION SYSTEM VIA INVERTERS.....	852
4.	INSPECTION, TESTING, COMMISSIONING, DISCONNECTION AND RECONNECTION.....	922
4.1	INSPECTION AND TESTING.....	922
4.2	COMMISSIONING OF <i>USER'S EQUIPMENT</i>	1032
4.3	DISCONNECTION AND RECONNECTION.....	1072
5.	TRANSMISSION AND DISTRIBUTION SYSTEM OPERATION and Coordination.....	1112
5.1	APPLICATION.....	1112
5.2	INTRODUCTION.....	1112
5.3	<i>POWER SYSTEM</i> OPERATION CO-ORDINATION RESPONSIBILITIES AND OBLIGATIONS.....	1112
5.4	CONTROL OF <i>TRANSMISSION SYSTEM VOLTAGES</i>	1132
5.5	<i>PROTECTION</i> OF <i>POWER SYSTEM EQUIPMENT</i>	1142
5.6	<i>POWER SYSTEM STABILITY</i> CO-ORDINATION.....	1162
5.7	<i>POWER SYSTEM SECURITY</i> OPERATION AND CO-ORDINATION.....	1162
5.8	OPERATIONS AND MAINTENANCE PLANNING.....	1182
5.9	<i>POWER SYSTEM OPERATING PROCEDURES</i>	1192

TECHNICAL RULES FOR THE SOUTH WEST INTERCONNECTED NETWORK

TABLE OF CONTENTS

5.10	<i>POWER SYSTEM OPERATION SUPPORT</i>	<u>1192</u>
5.11	<i>NOMENCLATURE STANDARDS</i>	<u>1212</u>
ATTACHMENT 1	- GLOSSARY	<u>1222</u>
ATTACHMENT 2	- INTERPRETATION.....	<u>1412</u>
ATTACHMENT 3	- SUMMARY OF SCHEDULES OF TECHNICAL DETAILS TO SUPPORT APPLICATION FOR CONNECTION	<u>1422</u>
ATTACHMENT 4	- LARGE <i>GENERATING UNIT</i> DESIGN DATA	<u>1452</u>
ATTACHMENT 5	- SUBMISSION REQUIREMENTS FOR ELECTRICAL PLANT PROTECTION	<u>1572</u>
ATTACHMENT 6	- LARGE <i>GENERATING UNIT</i> SETTING DATA.....	<u>1582</u>
ATTACHMENT 7	- <i>TRANSMISSION SYSTEM AND EQUIPMENT</i> TECHNICAL DATA OF <i>EQUIPMENT</i> AT OR NEAR <i>CONNECTION POINT</i>	<u>1602</u>
ATTACHMENT 8	- <i>TRANSMISSION SYSTEM EQUIPMENT</i> AND APPARATUS SETTING DATA.....	<u>1632</u>
ATTACHMENT 9	- <i>LOAD</i> CHARACTERISTICS AT <i>CONNECTION POINT</i>	<u>1652</u>
ATTACHMENT 10	: DISTRIBUTION SYSTEM CONNECTED GENERATORS UP TO 10 MW (EXCEPT INVERTOR-CONNECTED GENERATORS UP TO 30 KVA).....	<u>1662</u>
<i>ATTACHMENT 11</i> - TEST SCHEDULE FOR SPECIFIC PERFORMANCE VERIFICATION AND MODEL VALIDATION		<u>1732</u>
ATTACHMENT 12 - TESTING AND COMMISSIONING OF SMALL POWER STATIONS CONNECTED TO THE DISTRIBUTION SYSTEM.....		<u>1862</u>

1. GENERAL

1.1 INTRODUCTION

- (a) This section 1 defines the scope of the *Rules* both as to their content and their application. It provides rules of interpretation and refers to the dispute resolution process. It establishes the obligations of all parties and defines the methodology for variations, exemptions and amendments to these *Rules*.
- (b) The objectives of these *Rules* are that they:
 - (1) are reasonable;
 - (2) do not impose inappropriate barriers to entry to a market;
 - (3) are consistent with *good electricity industry practice*; and
 - (4) are consistent with relevant *written laws* and *statutory instruments*.

1.2 AUTHORISATION

These *Rules* are made under chapter 12 of the *Access Code*. They set out:

- (a) the required performance standards for service quality in relation to the *power system*;
- (b) the technical requirements for the design or operation of *equipment connected to the transmission and distribution systems*;
- (c) the requirements for the operation of the *transmission and distribution systems* (including the operation of the *transmission and distribution systems* in emergency situations or where there is a possibility of a person suffering injury but excluding the operation of those parts of the *transmission system* under the control of *System Management* acting in accordance with the Wholesale Electricity Market Rules);
- (d) the obligations of *Users* to test *equipment* in order to demonstrate compliance with the technical requirements referred to in clause 1.2(b) and the operational requirements referred to in clause 1.2(c);
- (e) the procedures which apply if the *Network Service Provider* believes that a *User's equipment* does not comply with the requirements of these *Rules*;
- (f) the procedures for the inspection of a *User's equipment*;
- (g) the procedures for system tests carried out in relation to all or any part of the *transmission and distribution systems*;
- (h) the requirements for control and *protection* settings for equipment connected to the *transmission and distribution systems*;

SECTION ONE - GENERAL

- (i) the procedures for the commissioning and testing of new *equipment connected to the transmission and distribution systems*;
- (j) the procedures for the *disconnection of equipment from the transmission and distribution systems*;
- (k) the procedures for the operation of generation that is not under the control of *System Management* but which is connected, either directly or indirectly, to the *transmission or distribution system*;
- (l) the information which each *User* is required to provide the *Network Service Provider* in relation to the operation of *equipment connected to the transmission and distribution systems* at the *User's connection point* and how and when that information is to be provided;
- (m) the requirements for the provision of a system for automatic under *frequency load shedding*;
- (n) other matters relating to the *transmission and distribution systems* or *equipment connected* directly or indirectly to the *transmission and distribution systems*; and
- (o) the *transmission and distribution systems* planning criteria as required by section A6.1(m) of the *Access Code*.

1.3 APPLICATION

- (a) In these *Rules*, unless otherwise stated, a reference to the *Network Service Provider* refers to the *service provider* for the *South West Interconnected Network*. The *service provider* for the *South West Interconnected Network*, is the Electricity Networks Corporation, a statutory corporation established by the Electricity Corporations Act (2005) (WA) but, for the purpose of these *Rules* does not include *System Management*.
- (b) These *Rules* apply to:
 - (1) the *Network Service Provider* in its role as the owner and *operator of the transmission and distribution systems*;
 - (2) *System Management* in its role as *operator of the power system*;
 - (3) *Users of the transmission or distribution system* who, for the purposes of these *Rules* include:
 - (A) every person who seeks access to *spare capacity* or *new capacity* on the *transmission or distribution system* or makes an *access application* under the *Access Code* in order to establish a *connection point* or modify an existing *connection*;

SECTION ONE - GENERAL

- (B) every person to whom access to *transmission* and *distribution* capacity is made available (including every person with whom the *Network Service Provider* has entered into an *access contract* or connection agreement).

1.4 COMMENCEMENT

These *Rules* come into operation on **dd Month 2006** (the "*Rules commencement date*").

1.5 INTERPRETATION

- (a) In these *Rules*, the words and phrases defined in Attachment 1 have the meanings given to them there.
- (b) These *Rules* must be interpreted in accordance with the rules of interpretation set out in Attachment 1 and Attachment 2.

1.6 THE NETWORK SERVICE PROVIDER AND USERS TO ACT REASONABLY

1.6.1 Importance of objectives

Subject to the *Access Code*, the *Network Service Provider* and *Users* must comply with these *Rules* and act in a manner consistent with the objectives of these *Rules* as set out in clause 1.1(b).

1.6.2 Acting reasonably

- (a) The *Network Service Provider* and *Users* must act reasonably towards each other in regard to all matters under these *Rules*.
- (b) Whenever the *Network Service Provider* or a *User* is required to make a determination, form an opinion, give approval, make any request, exercise a discretion or perform any act under these *Rules*, it must be formed, given, made, exercised or performed reasonably and in a manner that is consistent with the objectives of these *Rules* and be based on reasonable grounds, and not capriciously or arbitrarily refused, or unduly delayed.

1.7 DISPUTE RESOLUTION

All disputes concerning these *Rules* must be resolved in accordance with Chapter 10 of the *Access Code*.

1.8 OBLIGATIONS

1.8.1 General

- (a) *Users* and the *Network Service Provider* must maintain and operate (or ensure their authorised *representatives* maintain and operate) all *equipment* that is part of their respective *facilities* in accordance with:

SECTION ONE - GENERAL

- (1) relevant laws;
 - (2) the requirements of the *Access Code*;
 - (3) the requirements of these *Rules*; and
 - (4) *good electricity industry practice* and applicable *Australian Standards*.
- (b) Where an obligation is imposed under these *Rules* to arrange or control any act, matter or thing or to ensure that any other person undertakes or refrains from any act, that obligation is limited to a requirement to use all reasonable endeavours in accordance with the *Access Code*, to comply with that obligation.
- (c) If the *Network Service Provider*, *System Management* or a *User* fails to arrange or control any act, matter or thing or the acts of any other person, the *Network Service Provider*, *System Management* or *User* is not taken to have breached such obligation imposed under these *Rules* provided the *Network Service Provider*, *System Management* or *User* used all reasonable endeavours to comply with that obligation.

1.8.2 Obligations of the Network Service Provider

- (a) The *Network Service Provider* must comply with the performance standards described in these *Rules*.
- (b) The *Network Service Provider* must:
- (1) ensure that, for *connection points* on the *transmission and distribution systems*, every arrangement for *connection* with a *User* complies with all relevant provisions of these *Rules*;
 - (2) permit and participate in inspection and testing of *facilities* and *equipment* in accordance with clause 4.1;
 - (3) permit and participate in commissioning of *facilities* and *equipment* which is to be *connected* to the *transmission system* in accordance with clause 4.2;
 - (4) advise a *User* with whom there is an *access contract* of any expected interruption or reduced level of service at a *connection point* so that the *User* may make alternative arrangements for *supply* during such interruptions; and
 - (5) ensure that modelling data used for planning, design and operational purposes is complete and accurate and undertake tests, or require *Users* to undertake tests in accordance with clause 4.1, where there are grounds to question the validity of data.

SECTION ONE - GENERAL

- (c) The Network Service Provider must arrange for:
- (1) management, maintenance and operation of the *transmission and distribution systems* such that when the *power system* is in the *normal operating state* electricity may be transferred continuously at a *connection point* up to the *agreed capability* of that *connection point*;
 - (2) management, maintenance and operation of the *transmission and distribution systems* to minimise the number and impact of interruptions or service level reductions to *Users*; and
 - (3) restoration of the *agreed capability* of a *connection point* as soon as reasonably practicable following any interruption or reduction in service level at that *connection point*.

1.9 VARIATIONS AND EXEMPTIONS FROM THE RULES

1.9.1 *User Exemptions from these Rules*

- (a) An exemption from compliance with one or more of the requirements of these *Rules* may be granted to a *User* by the *Network Service Provider* in accordance with sections 12.33 to 12.39 of the *Access Code*.
- (b) For the avoidance of doubt, no exemption is required when the *Network Service Provider* properly and reasonably exercises a discretion granted to it under these *Rules*.
- (c) An application for an exemption must include the relevant supporting information and supporting justifications.

1.9.2 *Network Service Provider Exemptions from these Rules*

Exemptions from one or more requirements of these *Rules* may be granted to the *Network Service Provider* and all *applicants*, *Users* and *controllers* of the *transmission and distribution systems* by the *Authority* as set out in sections 12.40 to 12.49 of the *Access Code*.

1.9.3 *Amendment to the Rules*

- (a) The *Authority* may amend these *Rules* in accordance with sections 12.50 to 12.54 of the *Access Code*.
- (b) Where a *User* can demonstrate that an International or Australian Standard, which is not specified in these *Rules*, has equal or more onerous requirements to a specified Standard, the *Network Service Provider* must submit a proposal to the *Authority*, in accordance with the requirements of section 12.50 of the *Access Code*, to amend the *Rules* to include the proposed Standard. The submission must be supported by a report from a competent body, approved by the Australian National Association of Test Laboratories (NATA), which confirms

SECTION ONE - GENERAL

that the requirements of the proposed International or Australian Standards are equal or more onerous to those of the specified Standard.

1.9.4 ***Transmission and Distribution Systems and Facilities Existing at DD Month 2006***

- (a) All *facilities* and *equipment* in the *transmission and distribution systems*, all *connection assets*, and all *User facilities* and *equipment* connected to the *transmission or distribution system* existing at the *Rules commencement date* are deemed to comply with the requirements of these *Rules*. This also applies to *facilities* in respect of which *Users* have signed a *connection agreement* or projects of the *Network Service Provider* for which work has commenced prior to the *Rules commencement date*.
- (b) When *equipment* covered by clause 1.9.4(a) is upgraded or modified for any reason, the modified or upgraded *equipment* must comply with the applicable requirements of these *Rules*. This does not apply to other *equipment* that existed at the *Rules commencement date* and that forms part of the same *facility*.

1.9.5 ***Ongoing Suitability***

A *User* or the *Network Service Provider* whose *equipment* is deemed by clause 1.9.4 to comply with the requirements of these *Rules* must ensure that the capabilities and ratings of that *equipment* are monitored on an ongoing basis and must ensure its continued safety and suitability as conditions on the *power system* change.

SECTION 2 – TRANSMISSION AND DISTRIBUTION SYSTEM PERFORMANCE AND PLANNING CRITERIA

2. TRANSMISSION AND DISTRIBUTION SYSTEM PERFORMANCE AND PLANNING CRITERIA

2.1 INTRODUCTION

This section 2 describes the technical performance requirements of the *power system*, and the obligations of the *Network Service Provider* to provide the *transmission and distribution systems* that will allow these performance requirements to be achieved. In addition, it sets out criteria for the planning, design and construction of the *transmission and distribution systems*.

2.2 POWER SYSTEM PERFORMANCE STANDARDS

2.2.1 Frequency Variations

- (a) The nominal operating *frequency* of the *power system* is 50 Hz.
- (b) The *accumulated synchronous time error* must be less than 10 seconds for 99% of the time.
- (c) The *frequency operating standards* for the *power system* are summarised in [Table 2.1](#).

Table 2.1 Frequency Operating Standards for SWIS.

Condition	Frequency Band	Target Recovery Time
Normal Range:		
South West	49.8 to 50.2 Hz for 99% of the time	
Island ⁽¹⁾	49.5 to 50.5 Hz	
<i>Single contingency event</i>	48.75 to 51 Hz	Normal Range: within 15 minutes. For over-frequency events: below 50.5 Hz within 2 minutes
<i>Multiple contingency event</i>	47.0 to 52.0 Hz	Normal Range within 15 minutes For under-frequency events: (a) above 47.5 Hz within 10 seconds (b) above 48.0 Hz within 5 minutes (c) above 48.5 Hz within 15 minutes. (d) For over-frequency events: (e) below 51.5 Hz within 1 minute (f) below 51.0 Hz within 2 minutes (g) below 50.5 Hz within 5 minutes

Note: An island is formed when the *interconnection* between parts of the *interconnected transmission system* is broken, for example if the *interconnection* between the south-west and the Goldfields is broken.

SECTION 2 – TRANSMISSION AND DISTRIBUTION SYSTEM PERFORMANCE AND PLANNING CRITERIA

- (d) The *frequency* operating standards must be satisfied, provided that there is no shortage of spinning reserve in accordance with clause 3.10.2 of the Wholesale Electricity Market Rules, without the use of *load shedding* under all credible *power system load* and *generation* patterns and the most severe *credible contingency event*.
- (e) In the event of a loss of interconnecting equipment leading to the formation of an island separate from the rest of the *power system*, *load shedding facilities* within the island may be used to ensure that the *frequency* operating standards specified in Table 2.1 are satisfied within the islanded part of the *power system*. Once the *power system* within the island has returned to a steady state operating condition, the “island” frequency range in Table 2.1 will apply until the islanded *power system* is resynchronised to the main *power system*.
- (f) *Load shedding facilities* (described in clause 2.3.2) may be used to ensure compliance with the *frequency* operating standards prescribed in [Table 2.1](#) following a multiple contingency event.

2.2.2 Steady State Power *Frequency Voltage*

- (a) Except as a consequence of a non-credible contingency event, the minimum steady state *voltage* on the *transmission* system and those parts of the *distribution system* operating at *voltages* of 6 kV and above must be 90% of nominal *voltage* and the maximum steady state *voltage* must be 110% of nominal *voltage*. For those parts of the *distribution* system operating below *voltages* of 6 kV, the steady state *voltage* must be within:
 - (1) $\pm 6\%$ of the nominal *voltage* during *normal operating state*,
 - (2) $\pm 8\%$ of the nominal *voltage* during *maintenance conditions*,
 - (3) $\pm 10\%$ of the nominal *voltage* during *emergency conditions*.
- (b) Step *changes* in steady state *voltage* levels resulting from switching operations must not exceed the limits given in [Table 2.2](#).

Table 2.2 Step - Change Voltage Limits

Cause	Pre-tap-changing (quasi steady-state)		Post-tap-changing (final steady state)	
	≥ 66 kV	< 66 kV	≥ 66 kV	< 66 kV
Routine Switching ⁽¹⁾	±4.0% (max)	±4.0% (max)	<i>Transmission voltages</i> must be between 110% and 90% of nominal <i>voltage</i>	Must attain previous set point
Infrequent Switching ⁽²⁾	+6%, -10% (max)	+6%, -10% (max)	<i>Transmission voltages</i> must be between 110% and 90% of nominal <i>voltage</i>	Must attain previous set point

Notes:

1. For example, capacitor switching, *transformer* tap action, motor starting, start-up and shutdown of *generating units*.
2. For example, tripping of *generating units*, *loads*, lines and other components.

- (c) Where more precise control of voltage is required than is provided for under clause 2.2.2(a), a target range of *voltage* magnitude at a *connection point*, may be agreed with a *User* and specified in a *connection agreement*. This may include different target ranges under normal and post-contingency conditions (and how these may vary with *load*). Where more than one *User* is supplied at a *connection point* such that independent control of the *voltage* supplied to an individual *User* at that *connection point* is not possible, a target must be agreed by all relevant *Users* and the *Network Service Provider*. Where voltage magnitude targets are specified in a *connection agreement*, *Users* should allow for short-time variations within 5% of the target values in the design of their equipment.

2.2.3 Flicker

- (a) Rapid *voltage* fluctuations cause *changes* to the luminance of lamps which can create the visual phenomenon called flicker. Flicker severity is characterised by the following two quantities, which are defined in AS/NZS 61000.3.7 (2001):
- (1) P_{st} - short-term flicker severity term (obtained for each 10 minute period);
 - (2) P_{lt} - long-term flicker severity (obtained for each 2 hour period).
- (b) Under normal operating conditions, flicker severity caused by *voltage* fluctuation in the *transmission and distribution system* must be within the planning levels shown in [Table 2.3](#) for 99% of the time.

Table 2.3 Planning Levels for Flicker Severity

Flicker Severity Quantity	LV (415 V)	MV (≤ 35 kV)	HV-EHV (> 35 kV)
P_{st}	1.0	0.9	0.8
P_{lt}	0.65	0.7	0.6

Notes:

1. These values were chosen on the assumption that the transfer coefficients between MV or HV systems and LV systems are unity. The planning levels could be increased in accordance with AS61000.3.7 (2001).
2. The planning levels in [Table 2.3](#) are not intended to apply to flicker arising from *contingency* and other uncontrollable events in the *power system*, etc.

2.2.4 Harmonics

Under normal operating conditions, the harmonic *voltage* in the *transmission and distribution systems* must not exceed the planning levels shown in [Table 2.4](#) and [Table 2.5](#) (as applicable) appropriate to the *voltage* level.

Table 2.4 Distribution planning levels for harmonic voltage in networks with system voltage less than or equal to 35 kV (in percent of the nominal voltage)

Odd harmonics non multiple of 3		Odd harmonics multiple of 3		Even harmonics	
Order h	Harmonic voltage %	Order h	Harmonic voltage %	Order h	Harmonic voltage %
5	5	3	4	2	1.6
7	4	9	1.2	4	1
11	3	15	0.3	6	0.5
13	2.5	21	0.2	8	0.4
17	1.6	>21	0.2	10	0.4
19	1.2			12	0.2
23	1.2			>12	0.2
25	1.2				
>25	$0.2 + 0.5 \frac{25}{h}$				
Total harmonic distortion (THD): 6.5 %					

Table 2.5 Transmission planning levels for harmonic voltage in networks with system voltage above 35 kV (in percent of the nominal voltage)

Odd harmonics non multiple of 3		Odd harmonics multiple of 3		Even harmonics	
Order h	Harmonic voltage %	Order h	Harmonic voltage %	Order h	Harmonic voltage %
5	2	3	2	2	1.5
7	2	9	1	4	1
11	1.5	15	0.3	6	0.5
13	1.5	21	0.2	8	0.4
17	1	>21	0.2	10	0.4
19	1			12	0.2
23	0.7			>12	0.2
25	0.7				
>25	$0.2 + 0.5 \frac{25}{h}$				
Total harmonic distortion (THD): 3 %					

Notes:

1. The planning levels in [Table 2.4](#) and [Table 2.5](#) are not intended to apply to harmonics arising from uncontrollable events such as geomagnetic storms, etc.
2. The total harmonic distortion (THD) is calculated from the formula:

$$THD = \frac{U_{nom}}{U_1} \sqrt{\sum_{h=2}^{40} (U_h)^2}$$

where:

- U_{nom} = nominal voltage of a system;
- U_1 = fundamental voltage;
- U_h = harmonic voltage of order h expressed in percent of the nominal voltage.

3. [Table 2.4](#) and [Table 2.5](#) are consistent with AS 61000 (1998).

2.2.5 Negative Phase Sequence Voltage

The 30 minute average level of negative phase sequence voltage at all connection points must be equal to or less than the values set out in [Table 2.6](#).

Table 2.6 Limits for negative phase sequence component of *voltage* (in percent of the positive phase sequence component)

Nominal System Voltage (kV)	Negative Sequence Voltage (%)
> 100	1
10 – 100	1.5
< 10	2

2.2.6 Electromagnetic Interference

Electromagnetic interference caused by *equipment* forming part of the *transmission and distribution system* must not exceed the limits set out in Tables 1 and 2 of *Australian Standard AS2344* (1997).

2.2.7 Transient Rotor Angle Stability

All *generating units* connected to the *transmission system* and *generating units* within *power stations* that are connected to the *distribution system* and that have a total rated output of 10 MW or more must remain in *synchronism* following a *credible contingency event*.

2.2.8 Oscillatory Rotor Angle Stability

System oscillations originating from system electro-mechanical characteristics, electro-magnetic effect or non-linearity of system components, and triggered by any *small disturbance* or *large disturbance* in the *power system*, must remain within the *small disturbance rotor angle stability* criteria and the *power system* must return to a stable operating state following the disturbance. The *small disturbance rotor angle stability* criteria are:

- (a) The *damping ratio* of electromechanical oscillations must be at least 0.1.
- (b) For electro-mechanical oscillations as a result of a *small disturbance*, the *damping ratio* of the oscillation must be at least 0.5.
- (c) In addition to the requirements of clauses 2.2.8(a) and 2.2.8(b), the *halving time* of any electro-mechanical oscillations must not exceed 5 seconds.

2.2.9 Short Term Voltage Stability

- (a) Short term *voltage stability* is concerned with the *power system* surviving an initial disturbance and reaching a satisfactory new steady state.
- (b) Stable *voltage* control must be maintained following the most severe *credible contingency event*.

2.2.10 Temporary Over-Voltages

As a consequence of a *credible contingency event*, the power frequency *voltage* at all locations in the *power system* must remain within the over-voltage envelope shown in [Figure 2.2](#).

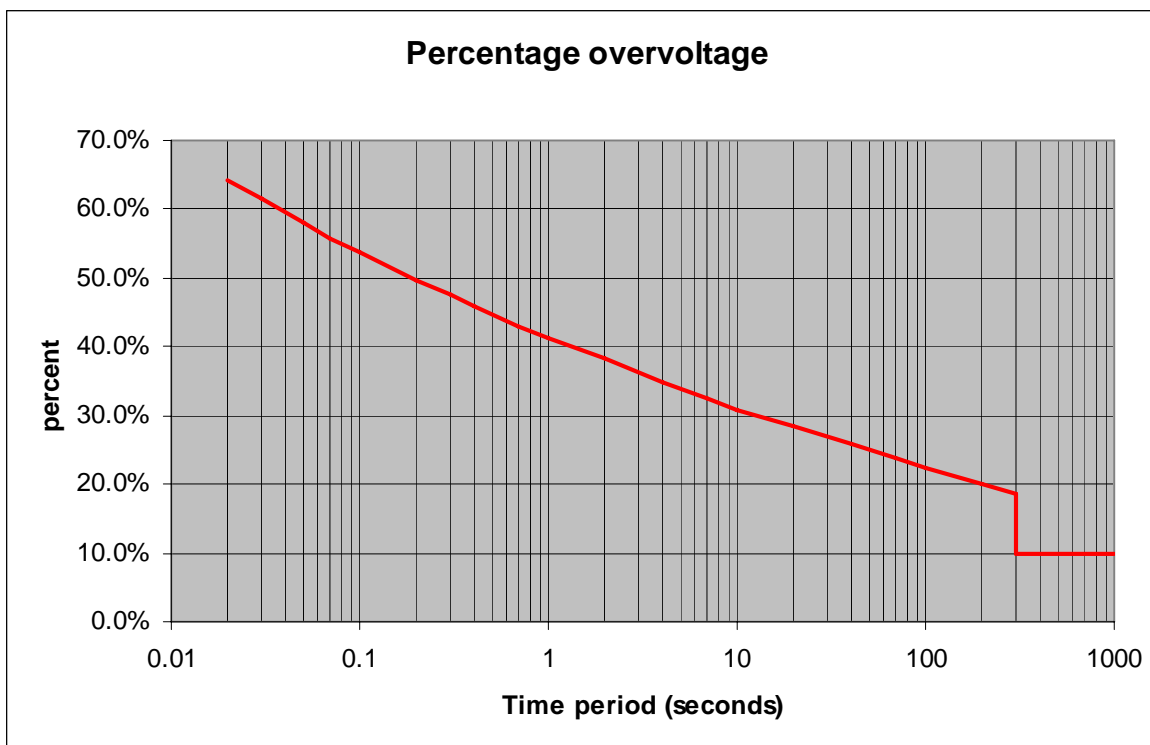

Figure 2.2 - Highest Acceptable Level and Duration of AC Temporary Over-Voltage

Notes:

1. In [Figure 2.2](#) the percentage voltage level refers to either the nominal *voltage* or the mid point of the target *voltage* range for a *connection point*, where such a range has been set in accordance with clause 2.2.2(c). For the purposes of this clause the voltage is the RMS phase to phase voltage.

2.2.11 Long Term Voltage Stability

- (a) Long term *voltage stability* includes consideration of slow dynamic processes in the *power system* that are characterised by time constants of the order of tens of seconds or minutes.
- (b) The long term *voltage stability* criterion is that the *voltage* at all locations in the *power system* must be stable and *controllable* following the most onerous post-contingent system state following the occurrence of any event specified in clauses 2.3.7.1(a) and 2.3.7.2 under all credible *load* conditions and *generation* patterns.

2.3 OBLIGATIONS OF NETWORK SERVICE PROVIDER IN RELATION TO POWER SYSTEM PERFORMANCE

2.3.1 Frequency Control

- (a) The *Network Service Provider* must design and install an automatic underfrequency *load shedding* system on the *transmission and distribution systems* to ensure that the *frequency* performance of the power system following a multiple *contingency event*, as specified in [Table 2.1](#), can be achieved. Further information on the technical requirements of this system is given in clause 2.4.
- (b) The automatic underfrequency *load shedding* system must be designed to ensure that, should a contingency event occur that results in the formation of islands, each island in the power system that contains generation has sufficient load shedding facilities to aid recovery of the frequency to the normal band within the time frames specified in [Table 2.1](#).
- (c) The *Network Service Provider* may require commercial and industrial *Consumers* to make a portion of their load available for automatic underfrequency or undervoltage *load shedding* or both and may also require a commercial or industrial *Consumer* to provide control and *monitoring equipment* for the *load shedding facilities*. The amount of load to be available for shedding and the frequencies or voltages or both at which load must be shed must be negotiated between the *Network Service Provider* and the *User* or, failing agreement between them, must be as specified by the *Network Services Provider* consistent with [Table 2.8](#), and must be specified in the relevant *connection agreement*.

2.3.2 Load to be Available for *Disconnection*

The *Network Service Provider* must ensure that up to 75% of the *power system load* at any time is available for *disconnection* under any one or more of:

- (1) the automatic control of underfrequency relays;
 - (2) manual or automatic control from *control centres*; and
 - (3) the automatic control of undervoltage relays.
- (b) To satisfy this overall criterion, the *Network Service Provider* may, at its discretion, arrange for up to 90% of the *power system load* if necessary to ensure that the *frequency* performance standard specified in clause 2.2.1 can be met for all credible *power system load* and *generation* patterns, to be available for automatic *disconnection*. The *Network Service Provider* must advise *Users* if this additional requirement is necessary.
 - (c) The *Network Service Provider* may install special *load shedding* arrangements to cater for abnormal operating conditions.

SECTION 2 – TRANSMISSION AND DISTRIBUTION SYSTEM PERFORMANCE AND PLANNING CRITERIA

- (d) Arrangements for *load shedding* must include the opening of circuits in the *distribution system* and may include the opening of circuits in the *transmission system*.
- (e) The Network Service Provider must use its best endeavours to assign feeders to stages within the *load shedding* system so that loads supplying *essential services* are not made available for shedding or are given a lower *load shedding* priority than other load.

2.3.3 Flicker

- (a) To ensure that the flicker level at any *point of common coupling* on the *transmission or distribution system* does not exceed the maximum levels specified in clause 2.2.3, the *Network Service Provider* must, where necessary and after consultation with the relevant *Users*, allocate flicker emission limits to *Users* in accordance with clauses 2.3.3(b) and 2.3.3(c).
- (b) The *Network Service Provider* must allocate contributions to limits no more onerous than the lesser of the acceptance levels determined in accordance with the stage 1 and the stage 2 evaluation procedures defined in AS/ANZ 61000.3.7 (2001).
- (c) If the *User* cannot meet the contribution calculated by using the method of clause 2.2.3(b), then the *Network Service Provider* may use, in consultation with the party seeking *connection*, the stage 3 evaluation procedure defined in AS/ANZ 61000.3.7 (2001).
- (d) The *Network Service Provider* must verify compliance of *Users* with allocated flicker emission levels. The contribution may be assessed by direct measurement or by calculation from the available data for the *load* and the *power system*. In verifying compliance, measurements of flicker must be carried out according to AS/NZS 61000 (2001).

2.3.4 Harmonics

- (a) To ensure that the harmonic or interharmonic level at any *point of common coupling* on the *transmission or distribution system* does not exceed the maximum levels specified in clause 2.2.4, the *Network Service Provider* must, where necessary and after consultation with the relevant *Users*, allocate harmonic emission limits to *Users* in accordance with AS/NZS 61000.3.6 (2001).
- (b) The *Network Service Provider* must verify compliance of *Users* with allocated harmonic or interharmonic emission levels. The contribution may be assessed by direct measurement or by calculation from the available data for the *load* and the *power system*.
- (c) The measurement must be carried out according to AS/NZS 61000.4.7 (2001). Harmonics must generally be measured up to h=40. However, higher order harmonics up to 100th order may be measured if the *Network Service Provider* reasonably considers them to be of material concern.

2.3.5 Negative Phase Sequence *Voltage*

- (a) If the maximum level of negative phase sequence voltage, as specified in Table 2.6, is exceeded at any *connection* point on the *transmission or distribution system*, the *Network Service Provider* must remedy the problem to the extent that it is caused by the *transmission and distribution systems*.
- (b) If, in the *Network Service Provider's* opinion, the problem is caused by an unbalance in the phase currents within a *User's equipment or facilities*, it must require the *User* to remedy the unbalance.

2.3.6 Electromagnetic Interference

The *Network Service Provider* must respond to all complaints regarding electromagnetic interference in a timely manner and undertake any necessary tests to determine whether or not the interference is caused by *equipment* forming part of the *transmission and distribution systems*, and whether or not it exceeds the limits specified in clause 2.2.6. If the complaint is justified, the *Network Service Provider* must, as soon as reasonably practicable, take any necessary action to reduce the interference to below the maximum prescribed levels.

2.3.7 Power System Stability and Dynamic Performance

2.3.7.1 Short Term Stability

- (a) The *Network Service Provider* must plan, design and construct the *transmission and distribution systems* so that the short term *power system* stability and dynamic performance criteria specified in clauses 2.2.7 to 2.2.10 are met under the worst credible system *load* and *generation* patterns, and the most critical, for the particular location, of the following *credible contingency events* without exceeding the rating of any *power system* component or, where applicable, the allocated *power transfer* capacity:
 - (1) a three-phase to earth fault cleared by *disconnection* of the faulted component, with the fastest main *protection scheme* out of service;
 - (2) a single-phase to earth fault cleared by the *disconnection* of the faulted component, with the fastest main *protection scheme* out of service;
 - (3) a single-phase to earth fault cleared after unsuccessful high-speed single-phase auto-reclosure onto a persistent fault;
 - (4) a single-phase to earth *small zone fault* or a single-phase to earth fault followed by a *circuit breaker failure*, in either case cleared by the operation of the fastest available *protection scheme*; or
 - (5) sudden *disconnection* of a system component, e.g. a *transmission line* or a *generation* unit.

SECTION 2 – TRANSMISSION AND DISTRIBUTION SYSTEM PERFORMANCE AND PLANNING CRITERIA

- (b) To ensure compliance with clause 2.3.7.1(a), the *Network Service Provider* must simulate the short term dynamic performance of the *power system*. Dynamic models of individual components must be verified and documented.
- (c) In planning the *transmission and distribution system*, the *Network Service Provider* must:
 - (1) assume a *transmission and distribution system* operating configuration with equipment out of service for maintenance where this is provided for in the planning criteria specified in clause 2.5; and
 - (2) use a *total fault clearance time* determined by the slower of the two *protection schemes*, where the *main protection system* includes two *protection schemes*. Where the main protection system includes only one *protection scheme*, the *back-up protection system total fault clearance time* must be used for simulations.

2.3.7.2 Short Term Voltage Stability

- (a) The assessment of the compliance of the *transmission and distribution systems* with the different short term *voltage stability* criteria specified in clause 2.2 must be made using simulation of the system response with the best available models of *voltage-dependent loads* (including *representative* separate models of motor loads where appropriate).
- (b) The assessment must be made using simulation of the system response with the short-term overload capability of the *voltage / excitation control system* capability of each *generating unit* or other reactive source represented (magnitude and duration). This is to include representation of the operation and settings of any limiters or other controls that may impact on the performance of *reactive power* sources.

2.3.7.3 Long Term Voltage Stability

- (a) In assessing the compliance of the *transmission and distribution systems* with the long term *voltage stability* criteria specified in clause 2.2.11, the *Network Service Provider* must first confirm that the *transmission and distribution systems* can survive the initial disturbance.
- (b) The long term voltage stability analysis must then be carried out by a series of *load-flow* simulations or by using dedicated long-term dynamics software to ensure that adequate *reactive power reserves* are provided within the *transmission and distribution systems* to meet the long term *voltage stability* criteria in clause 2.2.11, for all credible generation patterns and system conditions.
- (c) The *Network Service Provider* must model the *power system* for long term stability assessment and transfer limit determination purposes, pursuant to clause 2.3.7.3(b) using the following procedure:

SECTION 2 – TRANSMISSION AND DISTRIBUTION SYSTEM PERFORMANCE AND PLANNING CRITERIA

- (1) for terminal *substations* in the Perth metropolitan area, 3% of the total installed *capacitor banks* plus the reactive device that has the largest impact on the *power system* must be assumed to be out of service; and
- (2) for other areas of the *power system*, including radials:
 - (A) the normal peak *power system generation* pattern, or other credible *generation* pattern determined by operational experience to be more critical, that provides the lowest level of *voltage* support to the area of interest must be assumed. Of the *generating units* normally in service in the area, the *generating unit* that has the largest impact on that area must be assumed to be out-of-service due to a breakdown or other maintenance requirements. If another *generating unit* is assigned as a back-up, that *generating unit* may be assumed to be brought into service to support the *load area*; and
 - (B) the largest *capacitor bank*, or the reactive device that has the largest impact in the area, must be assumed to be out-of-service, where the area involves more than one *substation*.
- (3) In all situations the *Network Service Provider* must follow the following additional modelling procedures:
 - (A) all *loads* must be modelled as *constant P & Q loads*;
 - (B) the *load* or *power transfer* to be used in the study must be assumed to be 5% higher than the expected system *peak load*, or 5% higher than the maximum expected *power transfer* into the area. (The 5% margin includes a safety margin for hot weather, data uncertainty and uncertainty in the simulation). The *power system voltages* must remain within normal limits with this high *load* or *power transfer*;
 - (C) the analysis must demonstrate that a positive *reactive power reserve* margin is maintained at major *load points*, and that *power system voltages* remain within the normal operating range for this 5% higher *load*; and
 - (D) *power system* conditions must be checked after the *outage* and both prior to, and following, tap-changing of *transformers*.

2.3.7.4 Validation of Modelling Results

The *Network Service Provider* must take all reasonable steps to ensure that the results of the simulation and modelling of the *power system* in accordance with the requirements of

SECTION 2 – TRANSMISSION AND DISTRIBUTION SYSTEM PERFORMANCE AND PLANNING CRITERIA

clauses 2.3.7.1 to 2.3.7.3 and section 3 are valid. This may include *power system* and plant performance tests in accordance with clause 4.1.

2.3.8 Determination of Power Transfer Limits

- (a) The *Network Service Provider* must assign, on a request by a *User* or *System Management*, *power transfer* limits to *equipment* forming part of the *transmission and distribution systems*. The assigned *power transfer* limits must ensure that the system performance criteria specified in clause 2.2 are met and may be lower than the equipment thermal ratings. Further, the assigned *power transfer* limits may vary in accordance with different *power system* operating conditions and, consistent with the requirements of these *rules*, should to the extent practicable maximise the power transfer capacity made available to *Users*.
- (b) The *power transfer* assessed in accordance with clause 2.3.8(a) must not exceed 95% of the relevant *rotor angle*, or other *stability* limit as may be applicable, whichever is the lowest.
- (c) Where the power transfer limit assessed in accordance with clause 2.3.8(a) is determined by the thermal rating of *equipment*, short term thermal ratings should also be determined and applied in accordance with *good electricity industry practice*.

2.3.9 Assessment of Power System Performance

- (a) The *Network Service Provider* must monitor the performance of the *power system* on an ongoing basis and ensure that the *transmission and distribution systems* are augmented as necessary so that the *power system* performance standards specified in clause 2.2 continue to be met irrespective of changes in the magnitude and location of connected *loads* and *generating units*.
- (b) The *Network Service Provider* must ensure that system performance parameter measurements to ensure that the *power system* complies with the performance standards specified in clauses 2.2.1 to 2.2.5 are taken as specified in [Table 2.7](#). Records of all test results must be retained by the *Network Service Provider* and made available to the *Authority*, *System Management* or the *Independent Market Operator* on request.

Table 2.7 Power Quality Parameters Measurement

Parameter	Value measured	Frequency of measurement	Minimum measurement period	Data sampling interval
Fundamental Frequency	mean value over interval	Continuous	all the time	10 seconds
Power-frequency voltage magnitude	mean rms value over interval	In response to a complaint, or otherwise as required by the <i>Network Service Provider</i> .	one week	10 minutes
Short-term flicker severity	P_{st}	In response to a complaint, or otherwise as required by the <i>Network Service Provider</i> .	one week	10 minutes
Long-term flicker severity	P_{lt}	In response to a complaint, or otherwise as required by the <i>Network Service Provider</i> .	one week	2 hours
Harmonic / interharmonic voltage and voltage THD	mean rms value over interval	In response to a complaint, or otherwise as required by the <i>Network Service Provider</i> .	one week	10 minutes
Negative sequence voltage	mean rms value over interval	In response to a complaint, or otherwise as required by the <i>Network Service Provider</i> .	one week	10 minutes

Notes:

1. The power quality parameters, except fundamental *frequency* and negative sequence *voltage*, must be measured in each phase of a three-phase system.
2. The fundamental *frequency* must be measured based on line-to neutral *voltage* in one of the phases or line-to-line *voltage* between two phases.
3. Other parameters and data sampling intervals may be used to assess the *Network Service Provider's transmission and distribution system* and *User system* performance during specific events.

2.4 LOAD SHEDDING FACILITIES

2.4.1 Settings of Under-Frequency Load shedding Schemes

- (a) The settings for the under-frequency load shedding (UFLS) scheme are stated in [Table 2.8](#).
- (b) Switchable capacitor banks at substations must be shed in accordance with [Table 2.8](#).

Table 2.8 Under-Frequency Load shedding Scheme Settings for the South West Interconnected Network

Stage	Frequency (Hz)	Time Delay (sec)	Load Shed (%)	Cumulative Load Shed (%)	Capacitor shed (%)	Cumulative Capacitor Shed (%)
1	48.75	0.4	15	15	10	10
2	48.50	0.4	15	30	15	25
3	48.25	0.4	15	45	20	45
4	48.00	0.4	15	60	25	70
5	47.75	0.4	15	75	30	100

2.5 TRANSMISSION AND DISTRIBUTION SYSTEM PLANNING CRITERIA

2.5.1 Application

The planning criteria in this clause 2.5 apply only to the *transmission and distribution systems* and not to *connection assets*. The *Network Service Provider* must design *connection assets* in accordance with a *User's* requirements and the relevant requirements of section 3.

2.5.2 Transmission system

The *Network Service Provider* must design the *transmission system* in accordance with the applicable criteria described below:

2.5.2.1 N-0 Criterion

- (a) A sub-network of the *transmission system* designed to the N-0 criterion will experience the loss of the ability to transfer power into the area supplied by that sub-network on the loss of a *transmission element*. Following such an event this *power transfer* capability will not be restored until the *transmission element* has been repaired or replaced.
- (b) The N-0 criterion may be applied to sub-networks with a *peak load* of less than 20 MVA and to *zone substations* with a *peak load* of less than 10 MVA. The N-

SECTION 2 – TRANSMISSION AND DISTRIBUTION SYSTEM PERFORMANCE AND PLANNING CRITERIA

0 criterion also applies to the 220 kV *interconnection* supplying the Eastern Goldfields region.

In the event of an unplanned outage of the 220 kV *interconnection* supplying the Eastern Goldfields region the *power system* is expected to split into two islands. Arrangements are in place to supply the Kalgoorlie-Boulder city and Coolgardie town *loads* during an *interconnection* outage but *Users* outside these areas will need to make their own arrangements for any back-up generation requirement.

- (c) For a sub-network designed to the N-0 planning criteria, the *Network Service Provider* must use its best endeavours to transfer *load* to other parts of the *transmission or distribution system* to the extent that this is possible and that spare *power transfer* capacity is available. If insufficient back-up *power transfer* capacity is available, *load shedding* is permissible. Where a supply loss of long duration, the *Network Service Provider* must endeavour to ration access to any available *power transfer* capacity by rotating the *load shedding* amongst the *Consumers* affected.
- (d) At *zone substations* subject to the N-0 criterion, the *Network Service Provider* may, at its discretion, install a further *supply transformer* if insufficient back-up *power transfer* capacity is available to *supply loads* by means of the *distribution system* to allow planned *transformer* maintenance to occur at off peak times without shedding *load*.

2.5.2.2 N-1 Criterion

- (a) Any sub-network of the *transmission system* that is not identified within this clause 2.5.2 as being designed to another criterion must be designed to the N-1 planning criterion.
- (b) For sub-networks designed to the N-1 criterion (excluding a *zone substation* designed to the 1% risk or NCR criteria in accordance with clause 2.5.3.2), *supply* must be maintained and *load shedding* avoided at any *load* level and for any *generation* schedule following an outage of any single *transmission element*.
- (c) Following the loss of the *transmission element*, the *power system* must continue to operate in accordance with the *power system* performance standards specified in clause 2.2.
- (d) Notwithstanding the requirements clauses 2.5.2.2(b) and 2.5.2.2(c) , where the failed *transmission element* is a *zone substation supply transformer*, *supply* may be lost for a brief switching period while *loads* are transferred to un-faulted *supply transformers* by means of *distribution system* switching. The *Network Service Provider* must maintain sufficient *power transfer* capacity to allow *supply* to all *Consumers* to be restored following switching.

2.5.2.3 N-1-1 Criterion

- (a) The N-1-1 Criterion applies to those sub-networks of the *transmission system* where the occurrence of a *credible contingency* during planned maintenance of

SECTION 2 – TRANSMISSION AND DISTRIBUTION SYSTEM PERFORMANCE AND PLANNING CRITERIA

another *transmission element* would otherwise result in the loss of *supply* to a large number of *Consumers*. Sub-networks of the *transmission system* that are designed to the N-1-1 criterion include:

- (1) all 330 kV lines, *substations* and *power stations*;
 - (2) all 132 kV *terminal stations* in the Perth metropolitan area, and Muja *power station* 132 kV *substation*;
 - (3) all 132 kV *transmission lines* that *supply* a sub-system of the *transmission system* comprising more than 5 *zone substations* with total *peak load* exceeding 400 MVA; and
 - (4) all *power stations* whose total rated export to the *transmission system* exceeds 600 MW.
- (b) The range of operating conditions that are allowed for when planning a part of the *transmission system* to meet the N-1-1 criterion is set out in [Table 2.9](#).

Table 2.9 Transmission System Operating Conditions Allowed for by the N-1-1 Criterion

Maintenance <i>Outages</i> and Contingencies
<i>transmission line</i> maintenance and unplanned <i>transmission line</i> outage
<i>transformer</i> maintenance and unplanned <i>transformer</i> outage
<i>transformer</i> maintenance and unplanned <i>transmission line</i> outage
<i>busbar</i> maintenance and unplanned <i>transmission line</i> outage
<i>busbar</i> maintenance and unplanned <i>transformer</i> outage
circuit breaker maintenance and unplanned <i>transmission line</i> outage
circuit breaker maintenance and unplanned <i>transformer</i> outage
circuit breaker maintenance and unplanned <i>busbar</i> outage
<i>transmission line</i> maintenance and unplanned <i>transformer</i> outage

- (c) Under the N-1-1 criterion, each sub-network must be capable of withstanding the coincident planned and unplanned *outages* of *transmission elements* listed in [Table 2.9](#) at up to 80% of the expected *transmission system peak load*. In determining whether the N-1-1 criteria have been met, the *Network Service Provider* may assume that, during the planned *outage*, *generation* has been rescheduled to mitigate the effect of the subsequent unplanned *outage*.

SECTION 2 – TRANSMISSION AND DISTRIBUTION SYSTEM PERFORMANCE AND PLANNING CRITERIA

- (d) Following the unplanned *outage* of the *transmission element*, the *power system* must continue to operate in accordance with the performance standards specified in clause 2.2, provided the *transmission system load* remains below 80% of the expected *peak load*.

2.5.2.4 *Circuit Breaker Failure*

If a *circuit breaker failure* occurs and, as a result, a single phase to earth fault within a *transmission system* sub-network designed to the N-1-1 criterion is not cleared by a *main protection scheme*, the *power system* must return to a state that meets the steady state performance standards specified in clause 2.2.2 without *generation* rescheduling, provided that the *power transfer* at the time of the fault is no greater than 80% of the expected *transmission system peak load* and that, prior to the event, all *transmission system equipment* is in service.

2.5.3 **Perth Central Business District Criterion**

- (a) The Perth Central Business District (CBD) criterion applies to those sub-networks of the *transmission system* that transfer power to the *Perth CBD Zone* and it currently applies to the Milligan Street and Hay Street *zone substations* and the *transmission* lines that terminate in those *zone substations*. This coverage may be extended in the future as the Perth CBD grows.
- (b) Following any outage within a sub-network to which the Perth CBD criterion applies involving:
 - (1) one or two *transmission* lines;
 - (2) one or two *supply transformers*; or
 - (3) one *transmission line* and one *supply transformer*,and irrespective of whether any single *transmission element* outage is planned or unplanned, there must be sufficient *power transfer* capacity in the *transmission system* to maintain *supply* to all *Consumers* within the *Perth CBD Zone* without the need to reschedule generation.
- (c) For an unplanned *outage* of a single *supply transformer*, there may be a *supply* interruption to some *Consumers* of up to 30 seconds to allow for the automatic transfer of the affected *loads* to other *supply transformers* within the same *substation* or to other *substations* using capacity that is kept available for this purpose.
- (d) For unplanned *outages* of two *transmission elements* in accordance with clause 2.5.3(b), there may be a *supply* interruption to some *Consumers* of up to 2 hours to allow for the transfer of the affected *loads* to other *supply transformers* within the same *substation* or to other *substations* using capacity that is kept available for this purpose.

SECTION 2 – TRANSMISSION AND DISTRIBUTION SYSTEM PERFORMANCE AND PLANNING CRITERIA

- (e) Apart from the *supply* interruptions provided for in clauses 2.5.3(c) and 2.5.3(d), the *power system* must continue to meet the performance standards specified in clause 2.2.

2.5.3.2 Zone Substations

(a) The 1% Risk Criterion

The 1% Risk criterion permits the loss of supply to that portion of a *substation's peak load* that is demanded for up to 1% of time in a year (87 hours) following the unplanned *outage* of any *supply transformer* in that *substation*.

(b) Normal Cyclic Rating (NCR) Criterion

- (1) The NCR risk criterion permits the loss of a portion of *power transfer capacity* at a *substation* following the unplanned loss of a *supply transformer* within that *substation*.
- (2) The portion of the *power transfer capacity* that may be lost is the lesser of:
 - (A) 75% of the *power transfer capacity* of the smallest *supply transformer* within the *substation*; and
 - (B) 90% of the *power transfer capacity* of the rapid response spare *supply transformer*.

Explanatory note: Relationship between 1% Risk criterion and NCR criterion.

1. *Zone substations* require special consideration as they form the boundary between the *transmission system* and the *distribution system*. The 1% Risk Criterion and NCR Criterion permit higher *supply transformer* utilisation than that permitted by the N-1 criterion, but lower than that permitted by the N-0 criterion.
2. The 1% Risk and NCR criteria are based on sharing a common spare *supply transformer* among a population of *supply transformers* across a number of *zone substations* within a geographically confined area. A trade off is the risk of limited *load shedding* for as long as it takes to deploy and install a spare *supply transformer*. The acceptance of this risk determines the application of these two criteria.

2.5.3.3 Application of 1% Risk criterion

- (a) The *Network Service Provider* may apply the 1% Risk criterion to major regional *zone substations* outside the Perth metropolitan area.
- (b) No *zone substation* may be classified a 1% Risk *substation* unless a suitable system spare *transformer* is available to replace the failed *transformer* within a target period of 10 *days*.

SECTION 2 – TRANSMISSION AND DISTRIBUTION SYSTEM PERFORMANCE AND PLANNING CRITERIA

- (c) Following the loss of a *supply transformer* from a 1% Risk *zone substation* the *Network Service Provider* must use its best efforts to minimise *load shedding* by transferring load to other *zone substations* by utilising available spare capacity.

2.5.3.4 Application of the NCR Criterion

- (a) The *Network Service Provider* may apply the NCR Risk criterion to *zone substations* in the Perth metropolitan area. *Zone substations* supplying *essential services* and *zone substations* where the application of the NCR Risk criterion is technically or economically unviable may be exempt from classification as NCR classified *substations* and must fully meet the N-1 planning criteria.
- (b) No *zone substation* may be classified an NCR *substation* unless a rapid response spare *transformer* is available to temporarily replace the failed *supply transformer* within a target period of 12 hours.
- (c) Following the loss of a *supply transformer* from an NCR classified *zone substation*, the *Network Service Provider* must use its best efforts to minimise *load shedding* by transferring load to other *supply transformers* or *zone substations* by utilising available *spare capacity*.
- (d) Following the deployment of the rapid response spare *transformer*, the *Network Service Provider* must install a suitable spare *transformer* or procure a new *transformer* to replace the failed *transformer* permanently and release the rapid response spare *transformer* to cater for future contingencies.

2.5.4 High Voltage Distribution System

2.5.4.1 Application of the N-0 criterion

- (a) The *Network Service Provider* may, unless *good electricity industry practice* dictates otherwise, design and operate the *distribution system* to the N-0 criterion.
- (b) The *Network Service Provider* may negotiate an enhanced *security of supply* with *Users* requiring a high level of *supply* reliability. Details of the agreed enhanced level of *security of supply* must be included in the *connection agreement*. The *Network Service Provider* is under no obligation to provide a *User* with an enhanced level of *security* and *Users* should note that provision of an enhanced level of *security* through connection to the *transmission or distribution* system is often neither economic nor practical. Hence *Users* requiring an enhanced level of *security of supply* may need to make alternative arrangements such as the provision of on-site standby *generation*.

2.5.4.2 Distribution Feeders in the Perth CBD Zone

Distribution feeders in the *Perth CBD Zone* must be designed so that in the event of an unplanned loss of *supply* due to the failure of equipment on a high voltage *distribution system*, the *Network Service Provider* can use remotely controlled switching to restore *supply* to those sections of the *distribution feeder* not directly affected by the fault.

2.5.4.3 Urban *Distribution Feeders***(a) Existing Urban *Distribution Feeders***

Urban distribution feeders in existence at the *Rules commencement date* must be designed so that, in the event of an unplanned single feeder *outage* due to an equipment failure within the *zone substation* or a failure of the exit cable, the *load* of that feeder can be transferred to other *distribution feeders* by manual reconfiguration.

For existing feeders, due to historical *substation* and feeder loading practices, this design requirement may not currently be achieved at 100% peak load. In this event some *load shedding* may be necessary at times of high *load* after reconfiguration of the *distribution system* following the *outage* of a single *distribution feeder*. However, in the long term, future network reinforcements will allow for 100% of *peak load* to be transferred, thereby avoiding the need for such *load shedding*.

(b) Urban *Distribution Feeders Constructed After the Rules Commencement Date*

- (1) Where practical, any new urban *distribution feeder* must be split into two radial spurs at the end of the *zone substation* exit cable; and
- (2) the *distribution feeder* must be designed so that, if an unplanned single feeder *outage* occurs due to an *equipment* failure within the *zone substation* or a failure of the exit cable, the *load* on the faulted feeder can be transferred to other feeders with the following provisions:
 - (A) no other feeder will pick up more than 50% of the *peak load* from the faulted *distribution* feeder unless capacity has been specifically reserved to provide back-up;
 - (B) the feeder(s) picking up the *load* can be from another *zone substation*; and
 - (C) any new underground *distribution* feeder, or portion of a new underground feeder that has an installed *transformer* capacity of 1 MVA or more, must be designed so that, as soon as adjacent developments permit, an alternative source of *supply* that is normally open, but can be closed to provide *supply* if a fault occurs on the normal *supply*.

2.5.4.4 Radial Distribution Feeder Loads in the Perth Metropolitan Area

For all *distribution feeders* within the Perth metropolitan area, the *Network Service Provider* must limit the number of residential *Consumers* in a switchable feeder section to 860, if the switchable feeder section is not able to be energised through a back-up normally open interconnection.

2.5.4.5 Rural *Distribution Feeders*

Where technically and economically feasible, the *Network Service Provider* must provide normally open *interconnections* between adjacent rural *distribution feeders*.

2.5.5 *Low Voltage Distribution System*

2.5.5.1 General

- (a) The *Network Service Provider* may design the radial *low voltage distribution systems* to the N-0 criterion. However, where technically and commercially feasible, *interconnection* between *low voltage* feeders may be provided.
- (b) For underground residential subdivisions, the *Network Service Provider* must ensure that all *low voltage* circuits have a switching point for every 16 *connection points*.

2.5.5.2 Pole to Pillar *Connection Points* Mandatory

All new *low voltage connection points* and service mains, and upgrades to existing overhead service mains due to capacity increases, must be underground, even if the service mains are to be connected to an overhead *distribution line*.

2.5.6 Fault Limits

The calculated maximum fault level at any point in the *transmission and distribution system* must not exceed 95% of the *equipment* fault rating at that point.

2.5.7 Maximum Fault Currents

- (a) The *maximum fault current* at the connection point of a *User* connected to the *transmission system* shall be as specified in the relevant *connection agreement*.
- (b) The *Network Service Provider* must design and construct the *distribution system* so that the potential *maximum fault currents* do not exceed the following values:

(1)	415 V networks	31.5 kA where supplied from one transformer; or 63 kA where supplied from two transformers in parallel, except where a higher <i>maximum fault current</i> is specified in a <i>User's connection agreement</i> .
(2)	6.6 kV networks	21.9 kA
(3)	11 kV networks	25 kA
(4)	22 kV networks	16 kA

(5) 33 kV networks 13.1 kA

- (c) Equipment may be installed with a lower fault *current rating* in accordance with applicable requirements of the Electricity (Supply Standards and System Safety) Regulations 2001 where the fault level is unlikely to exceed the lower rating for *credible contingency events*.

2.6 DISTRIBUTION DESIGN CRITERIA

- (a) All *distribution systems* must be designed to *supply* the maximum reasonably foreseeable *load* anticipated for the area served. The maximum reasonably foreseeable *load* must be determined by estimating the *peak load* of the area after it has been fully developed, taking into account restrictions on land use and assuming current electricity consumption patterns.
- (b) *Distribution systems* must be designed to minimise the cost of providing additional *distribution system* capacity should electricity consumption patterns change.
- (c) *High voltage* switchgear and *distribution transformers* should be located close to the centre of the *loads* to be supplied.
- (d) The *Network Service Provider* may remotely monitor and/or control *high voltage* switchgear where this can be shown to be the most cost efficient approach to meeting the reliability targets set out in the *access arrangement*.
- (e) *High voltage* switchgear that is not remotely monitored must be fitted with local fault passage indication
- (f) *Distribution transformers* rated at 300 kVA or above must be fitted with load monitoring *equipment*. This must provide a local indication of actual and *peak load* and must be capable of being modified in future to enable remote monitoring of the *transformer load*.

2.7 TRANSMISSION AND DISTRIBUTION SYSTEM DESIGN AND CONSTRUCTION STANDARDS

The *Network Service Provider* must ensure that the *transmission and distribution system* complies with the Electricity (Supply Standards and System Safety) Regulations 2001, relevant codes standards and regulations, including the *Access Code*, Australian and International Electricity Commission (IEC) Standards, relevant Electricity Networks Association Guides and any relevant requirements of the *WA Electrical Requirements*.

2.8 DISTRIBUTION CONDUCTOR OR CABLE SELECTION

Extensions and reinforcements to the *distribution system* must be designed and constructed in accordance with a *distribution system* concept plan for the area. The installation must conform to the concept plan and use conductors or cables that are:

SECTION 2 – TRANSMISSION AND DISTRIBUTION SYSTEM PERFORMANCE AND PLANNING CRITERIA

- (a) configured with the objective of minimising the life time cost to the community; and
- (b) of a standard carrier size that is equal to or greater than that required for the reasonably foreseeable *load*.

2.9 TRANSMISSION AND DISTRIBUTION SYSTEM PROTECTION

2.9.1 General Requirements

- (a) All *primary equipment* on the *transmission and distribution system* must be protected so that if an *equipment* fault occurs, the faulted *equipment* item is automatically removed from service by the operation of circuit breakers or fuses. *Protection systems* must be designed and their settings coordinated so that, if there is a fault, unnecessary *equipment* damage is avoided and any reduction in *power transfer capability* or in the level of service provided to *Users* is minimised.
- (b) Consistent with the requirement of clause 2.9.1(a), *protection systems* must remove faulted *equipment* from service in a timely manner and ensure that, where practical, those parts of the *transmission and distribution system* not directly affected by a fault remain in service.
- (c) *Protection systems* must be designed, installed and maintained in accordance with *good electricity industry practice*. In particular, the *Network Service Provider* must ensure that all new *protection apparatus* complies with IEC Standard 60255 and that all new *current transformers* and *voltage transformers* comply with AS 60044 (2003).

2.9.2 Duplication of *Protection*

- (a) *Transmission system*
 - (1) *Primary equipment* operating at *transmission system voltages* must be protected by a *main protection system* that must remove from service only those items of *primary equipment* directly affected by a fault. The *main protection system* must comprise *two fully independent protection schemes of differing principle*. One of the independent *protection schemes* must include earth fault *protection*.
 - (2) *Primary equipment* operating at *transmission system voltages* must also be protected by a *back-up protection system* in addition to the *main protection system*. The *back-up protection system* must isolate the faulted *primary equipment* if a *small zone fault* occurs, or a *circuit breaker failure* condition occurs. For *primary equipment* operating at nominal voltages of 220 kV and above the *back-up protection system* must comprise *two fully independent protection schemes of differing principle* that must discriminate with other *protection schemes*. For *primary equipment* operating at nominal voltages of less than 220kV the *back-up protection system* must incorporate at least one *protection*

scheme to protect against small zone faults or a circuit breaker failure. For protection against small zone faults there must also be a second protection scheme and, where this is co-located with the first protection scheme, together they must comprise two fully independent protection schemes of differing principle.

- (3) The design of the *main protection system* must make it possible to test and maintain either *protection scheme* without interfering with the other.
- (4) *Primary equipment* operating at a *high voltage* that is below a *transmission system voltage* must be protected by two fully independent *protection systems* in accordance with the requirements of clause 2.9.2(b)(1).

(b) ***Distribution system***

- (1) Each item of *primary equipment* forming part of the *distribution system* must be protected by two independent *protection systems*. One of the independent *protection systems* must be a *main protection system* that must remove from service only the faulted item of *primary equipment*. The other independent *protection system* may be a *back-up protection system*.
- (2) Notwithstanding the requirements of clause 2.9.2(b)(1), where a part of the *distribution system* may potentially form a separate island the *protection system* that provides protection against islanding must comprise *two fully independent protection schemes of differing principle* and comply with the requirements of clause 2.9.2(a)(3).

2.9.3 Availability of Protection Systems

- (a) All *protection schemes*, including any *back-up* or *circuit breaker failure protection scheme*, forming part of a *protection system* protecting part of the *transmission or distribution system* must be kept operational at all times, except that one *protection scheme* forming part of a *protection system* can be taken out of service for period of up to 48 hours every 6 months.
- (b) Should a *protection scheme* forming part of the *main* or *back-up protection system* protecting a part of the *transmission system* be out of service for longer than 48 hours, the *Network Service Provider* must remove the protected part of the *transmission system* from service unless instructed otherwise by *System Management*.
- (c) Should either the two *protection schemes* protecting a part of the *distribution system* be out of service for longer than 48 hours, the *Network Service Provider* must remove the protected part of the *distribution system* from service unless the part of the *distribution system* must remain in service to maintain *power system stability*.

2.9.4 Maximum Total Fault Clearance Times

- (a) This clause 2.9.4 applies to zero impedance short circuit faults of any type on *primary equipment* at nominal system voltage. Where *critical fault clearance times* exist, these times may be lower and take precedence over the times stated in this clause 2.9.4. *Critical fault clearance time* requirements are set out in clause 2.9.5.
- (b) For *primary equipment* operating at *transmission system voltages* the maximum *total fault clearance times* in Table 2.11 and Table 2.12 apply to the nominal voltage of the circuit breaker that clears a particular fault contribution for both *minimum* and *maximum system conditions*. For *primary equipment* operating at *distribution system voltages* the maximum *total fault clearance times* specified for 33 kV and below may be applied to all circuit breakers required to clear a fault for *maximum system conditions*, irrespective of the nominal voltage of a circuit breaker.
- (c) For *primary equipment* operating at a nominal voltage of 220 kV and above, operation of either *protection scheme* of the *main protection system* must achieve a *total fault clearance time* no greater than the "No CB Fail" time given in [Table 2.11](#). Operation of either *protection scheme* of the *back-up protection system* must achieve a *total fault clearance time* no greater than the "CB Fail" time given in [Table 2.11](#).
- (d) For *primary equipment* operating at 132 kV and 66 kV:
- (1) One of the *protection schemes* of the *main protection system* must operate to achieve a *total fault clearance time* no greater than the "No CB Fail" time given in [Table 2.11](#). The other *protection scheme* of the *main protection system* must operate to achieve a *total fault clearance time* no greater than the "No CB Fail" time in [Table 2.12](#). The *back-up protection system* must achieve a *total fault clearance time* no greater than the "CB Fail" time in [Table 2.11](#), except that the second *protection scheme* that protects against *small zone faults* must achieve a *total fault clearance time* no greater than 400 msec;
 - (2) on 132 kV lines longer than 40 km, all *main* and *back-up protection schemes* must operate to achieve the relevant maximum *total fault clearance time* given in [Table 2.12](#); and
 - (3) on 66 kV lines longer than 40 km, one *protection scheme* of the *main protection system* must operate to achieve the *total fault clearance times* specified for 132 kV in Table 2.12 (rather than the times specified in [Table 2.11](#)). The other *protection scheme* of the *main protection system* must operate to achieve the maximum *total fault clearance times* specified for 66 kV in [Table 2.12](#).
- (e) For a *small zone fault* coupled with a *circuit breaker failure*, maximum *total fault clearance times* are not defined.

SECTION 2 – TRANSMISSION AND DISTRIBUTION SYSTEM PERFORMANCE AND PLANNING CRITERIA

- (f) In [Table 2.11](#) and [Table 2.12](#), for voltages of 66 kV and above, the term "local end" refers to the circuit breaker(s) of a *protection* system where the fault is located:
- (1) within the same *substation* as the circuit breaker;
 - (2) for a *transmission line* between two *substations*, at or within 50% of the line impedance nearest to the *substation* containing the circuit breaker, provided that the line is terminated at that *substation*.
 - (3) for a *transmission line* between more than two *substations*, on the same line section as the *substation* containing the circuit breaker, provided that the line is terminated at that *substation*.
- (g) In [Table 2.11](#) and [Table 2.12](#), for voltages of 66 kV and above, the term "remote end" refers to all circuit breakers required to clear a fault, apart from those specified in clause 2.9.4(f).

Where one or more circuit breakers required to clear a fault are located in a different *substation* from that at which a line is terminated, situations may arise where all circuit breakers required to clear a fault may operate within the remote end *total fault clearance* time.

- (h) In table 2.11, for primary equipment operating at nominal voltages of 33 kV and below, the term "local end" refers only to faults located within the substation in which a circuit breaker is located.
- (i) The term "existing equipment" refers to *equipment* in service at the *Rules commencement date*.

Table 2.11 Maximum *Total Fault Clearance Times* (msec).

		Existing Equipment No CB Fail	Existing Equipment CB Fail	New Equipment No CB Fail	New Equipment CB Fail
220 kV and above	Local end	120	370	100	270
	Remote end	180	420	140	315
66 kV and 132 kV	Local end	150	400	115	310
	Remote end	200	450	160	355
33 kV and below	Local end	1160	1500	1160	1500
	Remote end	Not defined	Not defined	Not defined	Not defined

Table 2.12 Alternative Maximum *Total Fault Clearance Times* (msec) for 132 kV and 66 kV lines.

		Existing Equipment No CB Fail	Existing Equipment CB Fail	New Equipment No CB Fail	New Equipment CB Fail
132 kV	Local end	150	400	115	310
	Remote end	400	650	400	565
66 kV	Local end	1000	Not defined	115	310
	Remote end	Not defined	Not defined	400	565

2.9.5 Critical Fault Clearance Times

- (a) Notwithstanding the requirements of clause 2.9.4, where necessary to ensure that the *power system* complies with the performance standards specified in clause

SECTION 2 – TRANSMISSION AND DISTRIBUTION SYSTEM PERFORMANCE AND PLANNING CRITERIA

2.2, the *Network Service Provider* may designate a part of the *transmission or distribution system* as subject to a *critical fault clearance time*. The *critical fault clearance time* may be lower than the standard maximum *total fault clearance time* set out in [Table 2.11](#). The network configurations to which the *critical fault clearance time* applies shall be specified by the *Network Service Provider*.

- (b) All *primary equipment* that is subject to a *critical fault clearance time* must be protected by a *main protection system* that meets all relevant requirements of clause 2.9.2(a). Both *protection schemes* of the *main protection system* must operate within a time no greater than the *critical fault clearance time* specified by the *Network Service Provider*.

2.9.6 Protection Sensitivity

- (a) *Protection schemes* must be sufficiently sensitive to detect fault currents in the *primary equipment* taking into account the errors in *protection apparatus* and *primary equipment* parameters under the system conditions in this clause 2.9.6.
- (b) For *minimum and maximum system conditions*, all *protection schemes* must detect and discriminate for all *primary equipment* faults within their intended normal operating zones.
- (c) For *abnormal equipment conditions* involving two *primary equipment* outages, all *primary equipment* faults must be detected by one *protection scheme* and cleared by a *protection system*. *Back-up protection systems* may be relied on for this purpose. *Fault clearance times* are not defined under these conditions.

2.9.7 Trip Supply Supervision Requirements

Where loss of power *supply* to its secondary circuits would result in *protection scheme* performance being reduced, all *protection scheme* secondary circuits must have *trip supply supervision*.

2.9.8 Trip Circuit Supervision Requirements

All *protection scheme* secondary circuits that include a circuit breaker trip coil have *trip circuit supervision*, which must monitor the trip coil when the circuit breaker is in both the open and closed position and alarm for an unhealthy condition.

2.9.9 Protection Flagging and Indication

- (a) All protective devices supplied to satisfy the *protection* requirements must contain such indicating, flagging and event recording that is sufficient to enable the determination, after the fact, of which devices caused a particular trip.
- (b) Any failure of the tripping supplies, *protection apparatus* and circuit breaker trip coils must be alarmed and the *Network Service Provider* must put in place operating procedures to ensure that prompt action is taken to remedy such failures.

3. TECHNICAL REQUIREMENTS OF *USER FACILITIES*

3.1 INTRODUCTION

- (a) This section 3 sets out details of the technical requirements which *Users* must satisfy as a condition of *connection* of any *equipment* to the *transmission and distribution systems* (including *embedded generating units*), except where granted an exemption by the *Network Service Provider* in accordance with sections 12.33 to 12.39 or the *Authority* in accordance with sections 12.40 to 12.49 of the *Access Code*.
- (b) The objectives of this section 3 are to facilitate maintenance of the *power system* performance standards specified in section 2.2, so that other *Users* are not adversely affected and that personnel and equipment safety are not put at risk following, or as a result of, the *connection* of a *User's equipment*.

The scope of these *Rules* does not include the technical requirements for the provision of *ancillary services* either in accordance with the relevant provisions of the Wholesale Electricity Market Rules or under a commercial arrangement with the *Network Services Provider*. *Users* who provide these *ancillary services* may be required to comply with technical requirements over and above those specified in this section 3. These additional requirements will be specified in the relevant *ancillary services* contract.

3.2 REQUIREMENTS FOR ALL *USERS*

3.2.1 *Power System Performance Standards*

- (a) A *User* must ensure that each of its *facilities* connected to the *transmission or distribution system* is capable of operation while the *power system* is operating within the parameters of the *power system* performance standards set out in clause 2.2.
- (b) **Flicker**
- A *User* must maintain its contributions to flicker at the *connection point* below the limits allocated by the *Network Service Provider* under clause 2.3.3.
- (c) **Harmonics**
- (1) A user must comply with any harmonic emission limits allocated by the Network Service Provider in accordance with clause 2.3.4(a).
- (2) Where no harmonic injection limit has been allocated in accordance with clause 2.3.4(a), a *User* must ensure that the injection of harmonics or interharmonics from its *equipment* or *facilities* into the *transmission or distribution systems* does not cause the maximum system harmonic voltage levels set out in [Table 2.4](#) and [Table 2.5](#) to be exceeded at the point of connection.

(3) A *User* must not inject into the *transmission or distribution system* any DC component of current produced by its own *equipment*.

(d) **Negative Phase Sequence Voltage**

A *User* connected to all three phases must balance the current drawn in each phase at its *connection point* so as to achieve 30-minute average levels of negative sequence *voltage* at all *connection points* that are equal to or less than the values set out in Table 2.6.

(e) **Electromagnetic Interference**

A *User* must ensure that the electromagnetic interference caused by its *equipment* does not exceed the limits set out in Tables 1 and 2 of *Australian Standard AS 2344 (1997)*.

(f) **Fault Levels**

(1) A *User* connected to the *transmission system* may not install or connect *equipment* at the *connection point* that is rated for a *maximum fault current* lower than that specified in the *connection agreement* in accordance with clause 2.5.8(a).

(2) A *User* connected to the *distribution system*, who is not a *small use customer*, must not install *equipment* at the *connection point* that is rated for a maximum fault current lower than that specified in clause 2.5.8(b) unless a lower *maximum fault current* is agreed with the *Network Service Provider* and specified in the *connection agreement*.

(3) *Small use customers* connected to the *distribution system* may install *equipment* with a fault level with a lower fault rating than the *maximum fault current* specified in clause 2.5.7(b)(1) in accordance with the applicable requirements of the *WA Electrical Requirements*.

Where a <i>User's equipment</i> increases the fault levels in the <i>transmission system</i> , responsibility for the cost of any upgrades to the <i>equipment</i> required as a result of the <i>changed power system</i> conditions will be dealt with by commercial arrangements between the <i>Network Service Provider</i> and the <i>User</i> .

3.2.2 Main Switch

Except as provided in clause 3.3.3.10, a *User* must be able to de-energise its own *equipment* without reliance on the *Network Service Provider*.

3.2.3 *User's Power Quality Monitoring Equipment*

(a) The *Network Service Provider* may require a *User* to provide accommodation and connections for the *Network Service Provider's* power quality monitoring and recording *equipment* within the *User's facilities* or at the *connection point*. In such an event the *User* must meet the requirements of the *Network Service*

Provider in respect of the installation of the *equipment* and shall provide access for reading, operating and maintaining this *equipment*.

- (b) The key inputs that the *Network Service Provider* may require a *User* to provide to the *Network Service Provider's* power quality monitoring and recording *equipment* include:
- (1) three phase *voltage* and three phase *current* and, where applicable, neutral *voltage* and *current*; and
 - (2) digital inputs for circuit breaker status and protection operate alarms hardwired directly from the appropriate devices. If direct hardwiring is not possible and if the *Network Service Provider* agrees, then the *User* may provide inputs measurable to 1 millisecond resolution and GPS synchronised.

3.2.4 Power System Simulation Studies

- (a) A *User* must provide to the *Network Service Provider* such of the following information relating to any of the *User's facilities* connected or intended to be connected to the *transmission system* as is required to enable the undertaking of *power system* simulation studies:
- (1) a set of functional block diagrams, including all transfer functions between feedback signals and *generating unit* output;
 - (2) the parameters of each functional block, including all settings, gains, time constraints, delays, dead bands and limits; and
 - (3) the characteristics of non-linear elements.
- (b) The *Network Service Provider* may provide any information it so receives to any *User* who intends to connect any *equipment* to the *transmission system* for the purposes of enabling that *User* to undertake any *power system* simulation studies it wishes to undertake, subject to that *User* or entering into a confidentiality agreement with the *Network Service Provider*, to apply for the benefit of the *Network Service Provider* and any *User* whose information is so provided, in such form as the *Network Service Provider* may require.

3.2.5 Technical Matters to be Coordinated

A *User* and the *Network Service Provider* must agree upon the following matters for each new or altered *connection*:

- (a) design at the *connection point*;
- (b) *protection*;
- (c) control characteristics;
- (d) communications, remote controls, indications and alarms;

- (e) insulation co-ordination and lightning protection;
- (f) fault levels and *total fault clearance times*;
- (g) switching and isolation facilities;
- (h) interlocking arrangements;
- (i) *synchronising facilities*;
- (j) provision of information;
- (k) computer model and *power system* simulation study requirements;
- (l) *load shedding* and islanding schemes; and
- (m) any special test requirements.

3.3 REQUIREMENTS FOR CONNECTION OF GENERATING UNITS

3.3.1 General

- (a) A *Generator* must comply at all times with applicable requirements and conditions of *connection* for *generating units* as set out in clause 3.3.
- (b) A *Generator* must operate *facilities* and *equipment* in accordance with any and all *directions* given by *System Management* and the *Network Service Provider* under these *Rules* or under any written law.
- (c) For generating *equipment* the combined rating of which is less than 10 MW and which is *connected* to the *distribution* system, the *connection* requirements of clause 3.6 or clause 3.7 apply. This clause 3.3 applies to *generating equipment* the combined rating of which is 10MW or greater.

NOTE: The 10 MW threshold is chosen to coincide with the cut-off size for compulsory participation in the WA wholesale market. Wholesale market participation is compulsory for <i>generation equipment</i> rated 10 MW and above.
--

- (d) A *generating unit* must have *equipment* characteristics and *control systems*, including the inertia (effective, presented to the *power system*), short-circuit ratio and *power system* stabilisers, sufficient not to cause any reduction of *power transfer capability* because of:
 - (1) reduced *rotor angle stability*;
 - (2) reduced *frequency stability*; or
 - (3) reduced *voltage stability*,relative to the level that would apply if the *generating unit* were not *connected*.

The effect of this clause is to prevent *generating units* being permitted to connect to the *transmission or distribution system* if, as a result of the connection of the *generator*, the *power transfer capability* of the *power system* will be reduced.

- (e) An unplanned trip of a *generating unit* must not cause an increased need for *load shedding* because of:
- (1) rate of change of *frequency*;
 - (2) magnitude of *frequency* excursion;
 - (3) *active power* imbalance;
 - (4) *reactive power* imbalance; or
 - (5) displacement of reactive capability,

over and above the level that would apply if the *generating unit* was not *connected*.

The effect of this clause is to limit the maximum *generating unit* size that is permitted to connect to the *transmission or distribution system*.

- (f) A *Generator* must ensure that its transients do not adversely affect the *Network Service Provider* and other *Users*.
- (g) Unless otherwise specified in these *Rules*, the technical requirements for *generating units* apply at the *connection point*.
- (h) A *generating unit* must *disconnect* from the *distribution system* if the *distribution feeder* to which it is *connected* is separated from the remainder of the *power system*.

3.3.2 Provision of Information

- (a) A *Generator* must provide all data required by the *Network Service Provider* to assess the impact of a *generating unit* on the performance and *security* of the *transmission and distribution system*.
- (b) Details of the kinds of data that may be required are included in Attachment 3, Attachment 4, and Attachment 5.

3.3.3 Detailed Technical Requirements Requiring Ongoing Verification

A *Generator* must verify compliance of its own *equipment* with the technical requirements of this clause 3.3.3 by the methods described in clause 4.1.3.

3.3.3.1 Reactive Power Capability

- (a) Each *generating unit*, and the *power station* in which the *generating unit* is located, must be capable of continuously providing its full *reactive power* output within the full range of steady state *voltages* at the *connection point* permitted under clause 2.2.2.

A <i>generating unit transformer's</i> tapping range may be used to achieve this capability.
--

- (b) (1) Each *synchronous generating unit*, while operating at any level of *active power* output between its registered maximum and minimum *active power* output level, must be capable of:
- (A) supplying at its *generator machine's* terminals an amount of *reactive power* of at least the amount equal to the product of the rated active power output of the *generating unit* at nominal voltage and 0.750; and
- (B) absorbing at its *generator machine's* terminals an amount of *reactive power* of at least the amount equal to the product of the rated active power output of the *generating unit* at nominal voltage and 0.484.

Refer to [Figure 3.1](#) for details.

This clause requires a <i>generator machine</i> , when producing its registered maximum <i>active power</i> output, to be capable of operating at any <i>power factor</i> between 0.8 lagging and 0.9 leading.
--

Figure 3.1 Synchronous generating unit. Minimum reactive power capability requirements at generator machine terminals shown shaded

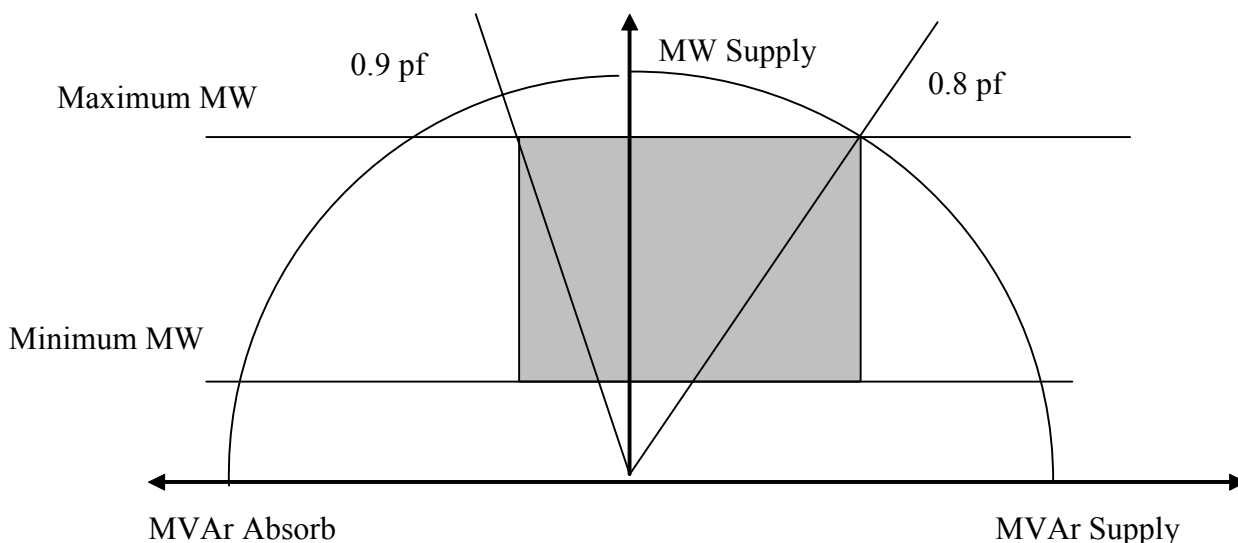

- (2) Each *induction generating unit*, while operating at any level of *active power* output between its registered maximum and minimum output level, must be capable of supplying or absorbing an amount of *reactive power* at the *connection point* of at least the amount equal to the product of the rated *active power* output of the *generating unit* at nominal voltage and 0.329. Refer to [Figure 3.2](#) for details.

This clause requires an *induction generating unit*, when producing its registered maximum *active power* output, to be capable of operating at any *power factor* between 0.95 lagging and 0.95 leading.

- (3) Where necessary to meet the performance standards specified in clause 2.2, the *Network Service Provider* may require an *induction generating unit* to be capable of supplying or absorbing a greater amount of *reactive power* output than specified in clause 3.3.4.1(b)(2). The need for such a requirement will be determined by *power system* simulation studies and any such a requirement must be included in the *connection agreement*.

Figure 3.2 Induction generating unit. Minimum reactive capability requirements at connection point shown shaded

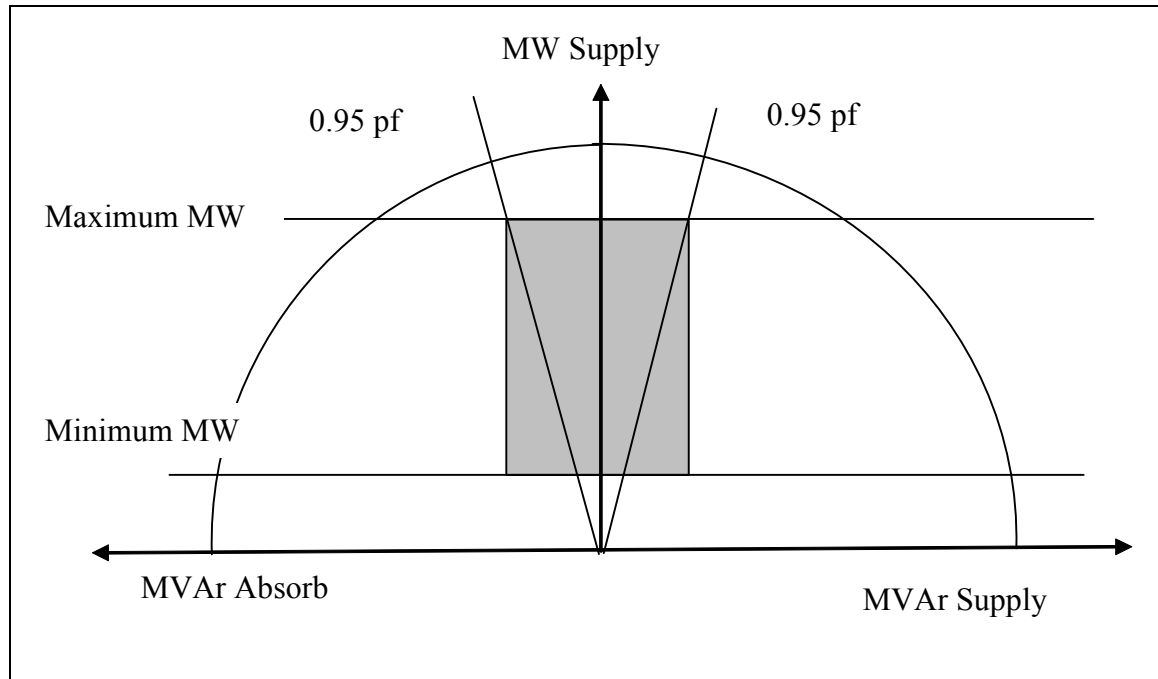

- (4) Each *inverter coupled generating unit* or *converter coupled generating unit*, while operating at any level of *active power* output between its registered maximum and minimum output level, must be capable of *supplying reactive power* such that at the inverter or converter *connection point* the *lagging power factor* is less than or equal to 0.95 and must be capable of *absorbing reactive power* at a *leading power factor* less than or equal to 0.95. Refer to [Figure 3.3](#) for details.
- (5) Where necessary to meet the requirements of these *Rules*, the *Network Service Provider* may require an *inverter generating unit* to be capable of *supplying a reactive power* output coincident with rated *active power* output over a larger *power factor* range. The need for such a requirement will be determined by *power system* simulation studies and any such a requirement must be included in the *connection agreement*.
- (c) For *generating units* not described by clause 3.3.3.1(b), the *power factor* requirements must be as advised by the *Network Service Provider* and included in the *connection agreement*. In determining the appropriate *power factor* requirement, the *Network Service Provider* must consider the intrinsic capabilities of such a new technology and the potential for its penetration.

Figure 3.3 Inverter coupled generating unit or converter coupled generating unit. Minimum reactive capability requirements at connection point shown shaded

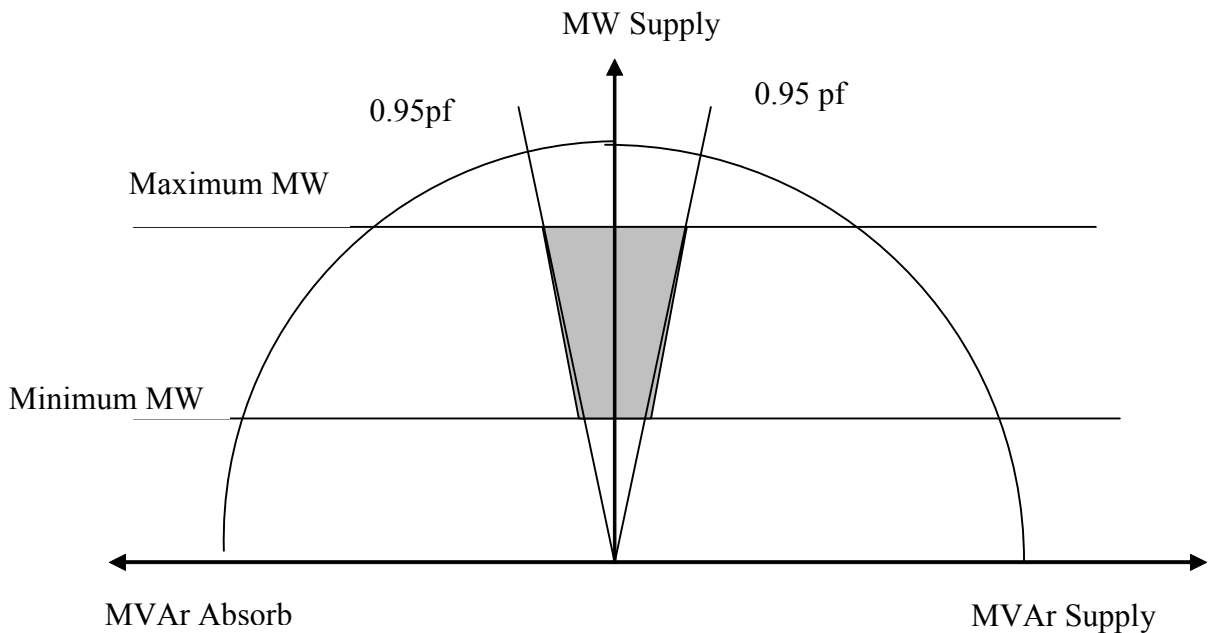

- (d) If the *power factor* capabilities specified in clause 3.3.3.1(b) cannot be provided, the *Generator* must reach an arrangement under the *connection agreement* with the *Network Service Provider* for the *supply* of the deficit in *reactive power* as measured at the relevant point of measurement. The basis for negotiation will be the responsibility of the proponent to provide an equivalent reactive performance (MVAr output) over a range of voltages at the connection point.

Clause 3.3.3.1(d) is intended to facilitate flexibility in design by assisting proponents to connect generating units that, of themselves, are not capable of meeting the reactive power generation requirements specified in clause 3.3.3.1(b) through providing for the shortfall to be made up through some other means.

- (e) Each *generating unit's connection* must be designed to permit the *dispatch* of the full *active power* and *reactive power capability* of the *facility* as specified in the *connection agreement* under all *power system* conditions contained in section 2.

3.3.3.2 Generating Unit Performance Standard

A *synchronous generating unit* or an *induction generating unit* must be designed to *generate* a constant *voltage* level with balanced phase *voltages* and harmonic *voltage* distortion equal to or less than permitted in accordance with either *Australian Standard AS 1359 (1997) "General Requirements for Rotating Electrical Machines"* or a recognised equivalent international standard as agreed between the *Network Service Provider* and the *User* if the *generating unit* was not connected to the *transmission or distribution system*.

3.3.3.3 *Generating Unit Response to Disturbances in the Power System***(a) Overview**

The following are design requirements for *generating units* and their auxiliary systems for continuous uninterrupted operation while being subjected to off-nominal *frequency* and *voltage* excursions. Continuous uninterrupted operation is defined in clause 3.3.3.3(h).

For *generating units connected* to the *distribution system*, some of these requirements may be relaxed when it is considered that failure to comply would not have a material impact on safety or *power system* performance. A *Generator* seeking a relaxation of the requirements must apply for an exemption from the *Rules*.

(b) Immunity to *Frequency Excursions*:

A *generating unit* and a *power station* in which the *generating unit* is located must be capable of continuous uninterrupted operation within the *power system frequency* envelope specified in [Figure 3.4](#). Operation for a period of at least 10 seconds is required each time the *frequency* is below 47.5 Hz. Operation for a period of at least 6 seconds is required each time the *frequency* is above 52 Hz. Below 47 Hz and above 52.5 Hz, instantaneous disconnection of *generating units* is permitted.

Figure 3.4 – Off nominal *frequency* operation capability requirement for *generating units*

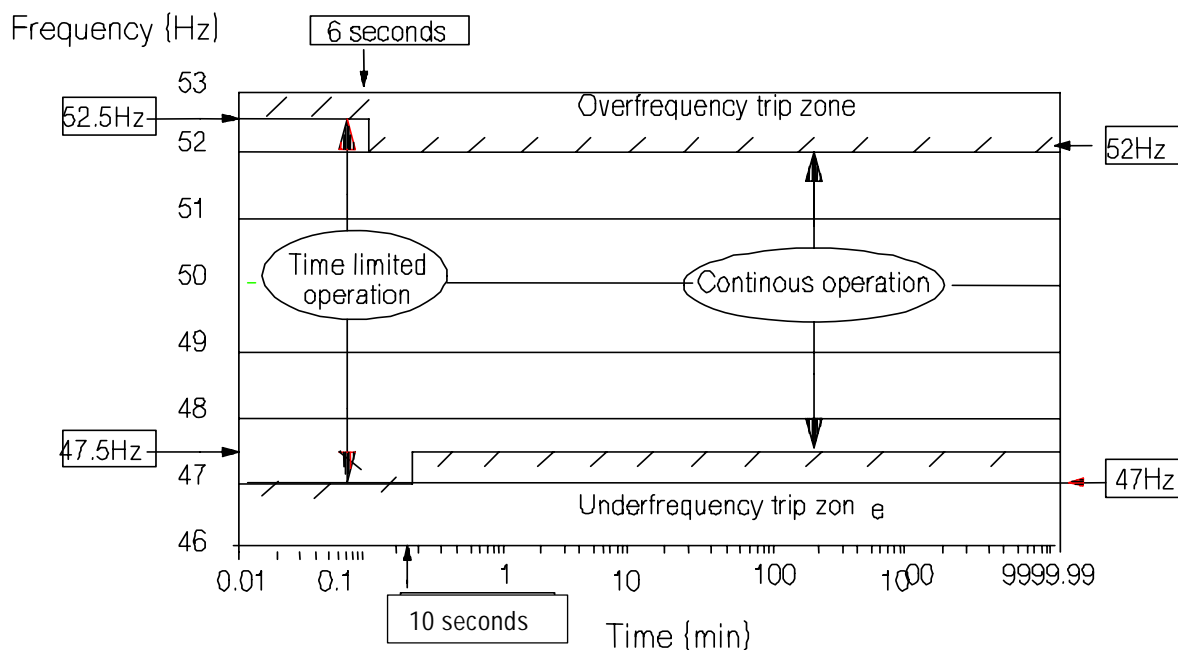

(c) **Immunity to Voltage Excursions:**

- (1) A generating unit and the power station in which the generating unit is located must be capable of continuous uninterrupted operation:
 - (A) for the range of voltage variations permitted by clause 2.2.2; and
 - (B) for transmission or distribution system faults which cause the voltage at the connection point to drop below the nominal voltage for a period equal to the circuit breaker failure fault clearing time to clear the fault plus a safety margin of 30 msec, followed by a period of 10 seconds where the voltage may vary in the range 80% to 110% of the nominal voltage, and a subsequent return of the voltage within the range 90 to 110% of the nominal voltage.
- (2) Notwithstanding the requirements of clause 3.3.3.3(c)(1)(B) no generating unit shall be required to be capable of continuous uninterrupted operation where the voltage at the connection point falls outside the envelope shown in Figure 3.5(a).

Figure 3.5a – Off nominal voltage operation capability requirement for generating units.

Nominal Voltage

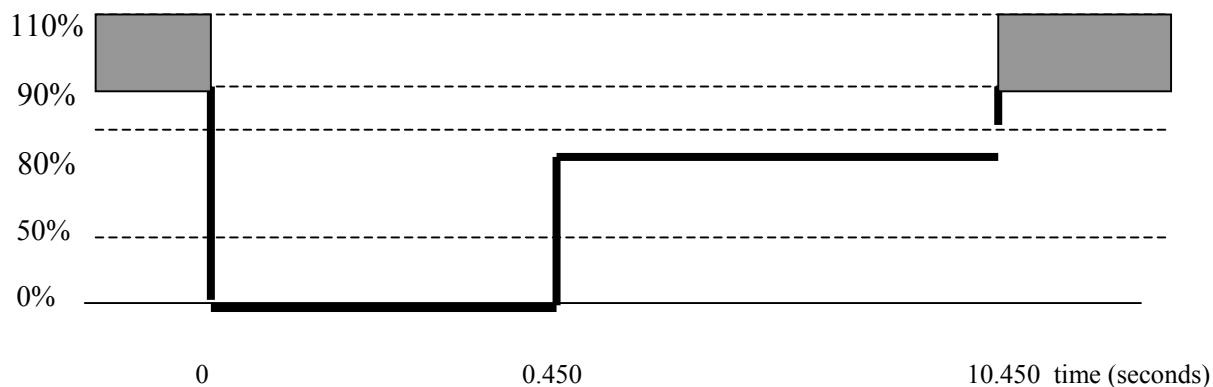

(d) **Immunity to Rate-of-Change-of-Frequency:**

A *generating unit* and the *power station* in which the *generating unit* is located must be capable of continuous uninterrupted operation for any rate-of-change-of-frequency of up to 4 Hz per second.

(e) **Immunity to High Speed Auto Reclosing:**

A *generating unit* and the *power station* in which the *generating unit* is located must be capable of continuous uninterrupted operation for *voltage* transients caused by high speed auto-reclosing of *transmission* lines irrespective of whether or not a fault is cleared during a reclosing sequence. See [Figure 3.5b](#) for details of the low *voltage* ride through requirement during auto-reclose operation.

Figure 3.5b - Off nominal voltage operation capability requirement for generating units during auto-reclose operation

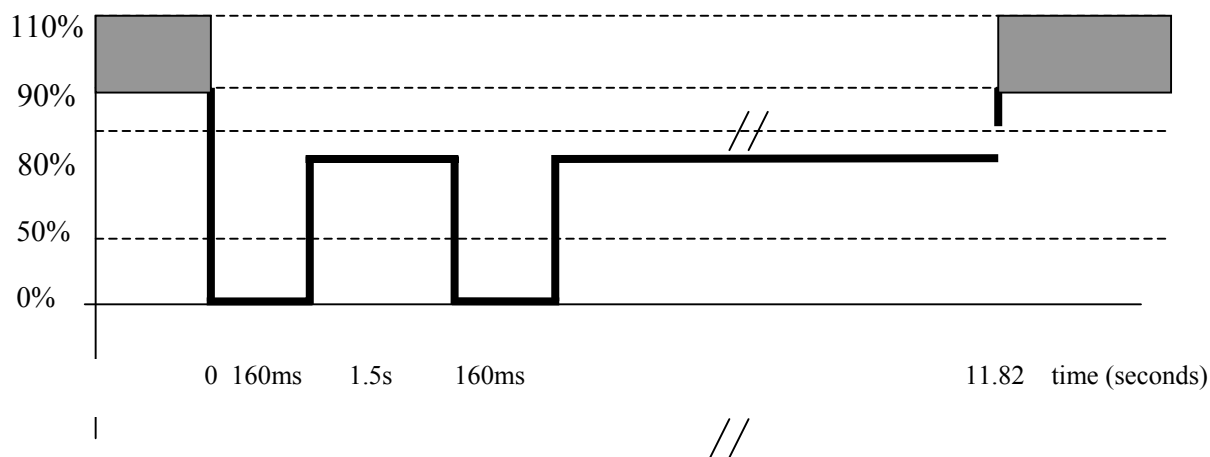

(f) **Post-Fault Reactive Power of a Power Station with Non-Synchronous Generating Units:**

After fault clearing, the *power station* in which a *non-synchronous generating unit* is located must not absorb *reactive power* from the *transmission system* or the *distribution system*. Any pre-fault absorption of *reactive power* has to be

terminated within 200 ms after clearing of the fault. The absorption is permitted to recommence, if required by the applicable *voltage* control strategy, after the post-fault *voltages* stabilize for at least 60 seconds at an above nominal value.

(g) **Post Fault Voltage Control of a Connection Point:**

Each *generating unit* must be fitted with a governor and a *voltage* regulator so that, following the occurrence of any *credible contingency event* and *changed power system* conditions after *disconnection* of the faulted element, the *generating unit* must be capable of delivering to the *transmission* or *distribution system* active power and reactive power sufficient to ensure that the *connection point voltage* is within the range for continuous uninterrupted operation for that *generating unit*.

(h) **Continuous Uninterrupted Operation:**

For the purposes of this clause 3.3.3.3, a *generating unit* is considered to remain in continuous uninterrupted operation if:

- (1) the *generating unit* is not disconnected from the *transmission or distribution system* due to *protection system* operation;
- (2) the *active power* output returns to the *generating unit's* pre-fault electric power output within 200 milliseconds after the *voltage* has returned to between 80% to 110% of nominal *voltage*. In making this assessment allowances may be made for:
 - (A) any variation in *active power* output for *non-synchronous generating units* due to variation in the primary source of energy must also be allowed for; and
 - (B) any variation in *active power* output of *synchronous generating units* due to any reduction in the *power system frequency* in accordance with the registered capability of the *generating unit*.
- (3) the *reactive power* control mode in which the *generating unit* was operating prior to the *credible contingency event* occurring does not change.

3.3.3.4 Sudden Reduction in Active Power Requirement

A *generating unit* must be capable of continuous uninterrupted operation as defined in clause 3.3.3.3(h) during and following a sudden reduction in required *active power generation* imposed from the *power system*, provided that the reduction is less than 30% of the *generator machine's nameplate rating* and the required *active power generation* remains above the *generating unit's* registered minimum *active power generation* capability.

3.3.3.5 Ramping Rates

- (a) A *scheduled generating unit*, in a thermally stable state, must be capable of increasing or decreasing *active power generation* in response to a manually or remotely initiated order to change the level of generated *active power* at a rate not less than 5% of the *generator machine's nameplate rating* per minute.
- (b) A *non-scheduled generating unit* must not increase or decrease its *active power generation* at a rate greater than 15% of the *generator machine's nameplate rating* per minute.

3.3.3.6 Safe Shutdown without External Electricity Supply

A *generating unit* must be capable of being safely shut down without an electricity *supply* being available from the *transmission* or *distribution system* at the relevant *connection point*.

3.3.3.7 Restart Following Restoration of External Electricity Supply

- (a) A *generating unit* must be capable of being restarted and synchronised to the *transmission* or *distribution system* without unreasonable delay following restoration of external *supply* from the *transmission* or *distribution system* at the relevant *connection point*, after being without external *supply* for 2 hours or less, provided that the *generating unit* was not *disconnected* due to an internal fault.

Examples of unreasonable delay in the restart of a *generating unit* are:

- delays not inherent in the design of the relevant start-up *facilities* and which could reasonably have been eliminated by the relevant *Generator*; and
- the start-up *facilities* for a new *generating unit* not being designed to minimise start up time delays for the *generating unit* following loss of external supplies for 2 hours or less and which could reasonably have been eliminated by the relevant *Generator*.

- (b) The maximum restart time, agreed by the *Generator* and the *Network Service Provider*, must be specified in the relevant *connection agreement*.

3.3.3.8 Protection of Generating Units from Power System Disturbances

- (a) A *generating unit* may be *disconnected* automatically from the *transmission* or *distribution system* in response to abnormal conditions arising from the behaviour of the *power system*. However, a *generating unit* must not be disconnected if the *power system* conditions at the *connection point* remain within the envelope described in clause 3.3.3.3 for continuous uninterrupted operation.

- (b) The abnormal *conditions* referred to in clause 3.3.3.8(a) include:
- (1) loss of *synchronism*;
 - (2) high or low *frequency* outside the generator off-nominal frequency operation capability requirements specified in [Figure 3.4](#);
 - (3) sustained excessive *generating unit* stator current that cannot be automatically controlled;
 - (4) high or low stator *voltage* outside *generator machine* rating;
 - (5) *voltage* to *frequency* ratio outside *generator machine* rating;
 - (6) negative phase sequence current outside *generator machine* rating; and
 - (7) any similar condition agreed between the *Generator* and the *Network Service Provider* after consultation with *System Management*.
- (c) The actual design and settings of the *protection equipment* installed in order to disconnect a *generating unit* in accordance with clause 3.3.3.8(a) must be consistent with *power system* performance requirements specified in section 2 and must be approved by the *Network Service Provider*.

3.3.3.9 *Generating Unit Transformer*

(a) **Transformer Impedance:**

The maximum permitted impedance of a *generating unit transformer* is 20% of the *generator's* MVA rating.

(b) **Vector Group:**

A *generating unit transformer's* vector group must be agreed with the *Network Service Provider*. The vector group must be compatible with the *power system* at the *connection point* and preference may be given to vector groups with a zero sequence opening between high *voltage* and low *voltage* windings.

(c) **Tap Changing:**

A *generating unit transformer* of a *generating unit* or *wind farm* must be capable of on-load tap-changing within the range specified in the relevant *connection agreement*.

3.3.3.10 *De-energisation of Generator Circuits*

The *Network Service Provider's* relevant circuit breaker may be used as a point of de-energisation, instead of the main switch specified in clause 3.2.2 provided that the *Generator* meets the following requirements:

- (a) the *Generator* must be able to synchronise any parallel *generating equipment* to the *transmission or distribution system* across a circuit breaker owned by the *Generator*;
- (b) the *Generator* must be able to clear a fault on its *equipment*:
 - (1) without adversely affecting any other *User* or potential *User*; and
 - (2) within the *fault clearance times* specified in clause 3.5.2(b);

provided that the *substation* where the *Network Service Provider's* relevant circuit breaker is located is in its normal operating configuration.
- (c) if:
 - (1) the *Generator* has only one circuit at the *connection point*; and
 - (2) the *Network Service Provider's* relevant circuit breaker is located in a meshed *substation*,

and if:

 - (3) the *Generator's facilities* are continuously manned with personnel capable of resetting a hand-reset *protection relay*; or
 - (4) the *Generator's facilities* have self-resetting relays,

then the *Generator* may de-energise its *equipment* by sending a trip signal to the *Network Service Provider's* relevant circuit breaker.
- (d) the *Generator* must own a visible point of isolation between the *Network Service Provider's* relevant circuit breaker and the *Generator's equipment* for each piece of *equipment connected to the transmission or distribution system*.

Under the relevant *connection agreement*, the *Network Service Provider* will require the *Generator* to indemnify the *Network Service Provider* from any and all liability for any direct or indirect damage caused to the *User* as a result of the *Generator's* electing to use any *Network Service Provider's* circuit breaker to clear a fault under clause 3.3.3.10(c).

3.3.4 Monitoring and Control Requirements

3.3.4.1 Remote Monitoring

- (a) The *Network Service Provider* or *System Management* may require a *User* to:
 - (1) provide *remote monitoring equipment (RME)* to enable the *Network Service Provider* or *System Management* to monitor performance of a *generating unit* (including its *dynamic performance*) remotely where this is necessary in real time for control, planning or *security* of the *power system*; and

SECTION 3 – TECHNICAL REQUIREMENTS OF USER FACILITIES

- (2) upgrade, modify or replace any *RME* already installed in a *power station* provided that the existing *RME* is, in the opinion of the *Network Service Provider*, no longer fit for purpose and notice is given in writing to the relevant *Generator* accordingly.
- (b) Any *RME* provided, upgraded, modified or replaced (as applicable) under clause 3.3.4.1(a), must conform to an acceptable standard as agreed by the *Network Service Provider* and must be compatible with the *Network Service Provider's* and *System Management's SCADA system*.
- (c) Input information to *RME* may include the following:
 - (1) Status Indications
 - (A) *generating unit* circuit breaker open/closed (dual point);
 - (B) remote *generation load* control on/off;
 - (C) *generating unit* operating mode;
 - (D) turbine control limiting operation; and
 - (E) *connection* to the *transmission* or *distribution system*;
 - (2) Alarms
 - (A) *generating unit* circuit breaker / main switch tripped by *protection*;
 - (B) prepare to off *load*; and
 - (C) *protection* defective alarms;
 - (3) Measured Values
 - (A) *transmission system*:
 - (i) gross *active power* output of each *generating unit*;
 - (ii) gross *reactive power* output of each *generating unit*;
 - (iii) net station *active power* import or export at each *connection point*;
 - (iv) net station *reactive power* import or export at each *connection point*;
 - (v) *generating unit* stator *voltage*;

- (vi) *generating unit transformer tap position;*
- (vii) *net station output of active energy (impulse);*
- (viii) *generating unit remote generation control high limit value;*
- (ix) *generating unit remote generation control low limit value; and*
- (x) *generating unit remote generation control rate limit value;*
- (B) *distribution system:*
 - (i) *main switch active power import or export;*
 - (ii) *main switch reactive power import or export; and*
 - (iii) *voltage on the Network Service Provider side of main switch; and*
- (4) *such other input information reasonably required by the Network Service Provider or System Management.*

3.3.4.2 Remote control

- (a) *The Network Service Provider or System Management may, for any generating unit which may be unattended when connected to the transmission or distribution system, require the Generator to:*
 - (1) *provide remote control equipment to enable the Network Service Provider or System Management to disconnect a generating unit from the transmission or distribution system; and*
 - (2) *upgrade, modify or replace any RCE already installed in a power station provided that the existing RCE is, in the opinion of the Network Service Provider or System Management, no longer fit for purpose and notice is given in writing to the relevant User accordingly.*
- (b) *Any RCE provided, upgraded, modified or replaced (as applicable) under clause 3.3.4.2(a) must conform to an acceptable standard as agreed by the Network Service Provider and must be compatible with the Network Service Provider's SCADA system, including the requirements of clause 5.11.*

3.3.4.3 Communications Equipment

- (a) *A Generator must provide communications paths (with appropriate redundancy) between the RME and RCE installed at any of its generating units to a communications interface at the relevant power station and in a location*

acceptable to the *Network Service Provider*. For *connections* to *distribution* system, this nominated location is in the *zone substation* from which the *distribution* feeder to which the *User* is *connected* emanates. Communications systems between this communications interface and the relevant *control centre* are the responsibility of the *Network Service Provider*, unless otherwise agreed.

- (b) Telecommunications between the *Network Service Provider* and *Generators* must be established in accordance with the requirements set out below for *operational communications*.
- (c) Primary Speech Communication Channel
 - (1) A *Generator* must provide and maintain a speech communication channel by means of which routine and emergency control telephone calls may be established between the *Generator's* responsible engineer or *operator* and *System Management* or the *Network Service Provider*, whichever is applicable.
 - (2) The speech communication channel provided must meet the requirements of the *Network Service Provider* and *System Management*.
 - (3) Where the public switched telephone network is to be used as the primary speech communication channel, a sole-purpose connection, which must be used only for operational communications, must be provided.
- (d) Back-up Speech Communications Channel
 - (1) The *Network Service Provider* must provide a separate telephone link or other back-up speech communications channel for the primary speech communications channel.
 - (2) The *Network Service Provider* must be responsible for planning installing and maintaining the back-up speech communications channel, and for obtaining radio licenses if required.
 - (3) The *Network Service Provider* may recover the cost of providing the backup speech communications channel from the generator as agreed in the relevant *connection agreement*.

3.3.4.4 Frequency Control

- (a) All *generating units* must have an automatic variable speed control characteristic. *Turbine control systems* must include *facilities* for both speed and load control.
- (b) *Generating units* must be capable of operation in a mode in which they will automatically and accurately alter *active power* output (every four seconds) to allow for *changes* in *associated loads* and for *changes* in *frequency* of the

transmission and distribution system and in a manner to sustain high initial response.

For steam <i>generating units</i> , this mode is known as the coordinated boiler follow mode.

(c) A *Generator* must, unless *System Management* instructs otherwise, operate a *generating unit* in the mode specified in clause 3.3.4.4(b).

(d) **Dead band**

The dead band of a *generating unit* (the sum of increase and decrease in *power system frequency* before a measurable *change* in the *generating unit's active power* output occurs) must be less than 0.05 Hz.

(e) **Control Range**

(1) For *synchronous generating units*:

(A) The overall response of a *synchronous generating unit* for *power system frequency* excursions must be settable and be capable of achieving an increase in the *generating unit's active power* output of not less than 5% for a 0.1 Hz reduction in *power system frequency* (4% droop) for any initial output up to 85% of rated output.

(B) A *synchronous generating unit* must also be capable of achieving a reduction in the *generating unit's active power* output of not less than 5% for a 0.1 Hz increase in system *frequency* provided this does not require operation below the *technical minimum*.

(C) For initial outputs above 85% of rated *active power* output, a *generating unit's* response capability must be included in the relevant *connection agreement*, and the *Generator* must ensure that the *generating unit* responds in accordance with that *connection agreement*.

(D) *Thermal generating units* must be able to sustain *load changes* of at least 10% for a *frequency* decrease and 30% for a *frequency* increase if *changes* occur within the above limits of output. Multiple fuel *generating units* must have the same response to the system *frequency* changes regardless of which fuel type they are running on at any given time.

(2) For *non-synchronous generating units*:

(A) The overall response of a *non-synchronous generating unit* for *power system frequency* excursions must be settable and

be capable of achieving a reduction in the *generating unit's active power* output for an increase in system *frequency*, provided the latter does not require operation below *technical minimum*.

- (B) *Non-synchronous generating units* utilising technologies which intrinsically allow the control of *active power* output must be equipped with such controls to facilitate *frequency* control.

For example, wind turbines with pitch control can control electric power output relative to the maximum *energy* that can be extracted from the wind. Hence wind turbines must have pitch control fitted.

(f) **Rate of Response**

- (1) For *dispatchable generating units*, for any *frequency* disturbance, a scheduled *generating unit* must achieve at least 90% of the maximum response expected according to the droop characteristic within a time to be specified in the relevant *connection agreement*.

This time is typically 6 seconds for *thermal generating units* and the new output must be sustained for 30 seconds. The time is typically 30 seconds for hydro *generating units* and the new output must be sustained indefinitely.

- (2) For *non-synchronous generating units*, or any *frequency* disturbance, a *generating unit* must achieve at least 90% of the maximum response expected within a time to be specified in the relevant *connection agreement*.

The time is typically 2 seconds for wind and solar *generating units* and the new output must be sustained indefinitely.

3.3.4.5 Voltage Control System

The overriding objective of a *generating unit's voltage control system* is to maintain the specified *voltage* range at the *connection point*.

Each *Generator* must therefore provide sufficient *reactive power* injection into, or absorption from, the *transmission or distribution system* to meet the *reactive power* requirements of its *loads*, plus all *reactive power* losses required to deliver its real power output at system *voltages* within the ranges specified in the relevant *connection agreement* for normal operation and contingency

conditions.

- (a) The *excitation control system* of a *synchronous generating unit* must be capable of:
- (1) limiting the *reactive power* absorbed or supplied by the *generating unit* to within *generating unit's* capability for continuous operation given its *load* level;
 - (2) controlling the *generating unit's* excitation to maintain the short-time average *generating unit* stator *voltage* below its highest rated level (which must be at least 5% above the nominal stator *voltage*);
 - (3) maintaining adequate *generating unit* stability under all operating conditions and providing *power system* stabilising action if fitted with a *power system* stabiliser;
 - (4) providing a 5 second ceiling excitation *voltage* of at least twice the excitation *voltage* required to achieve maximum continuous *reactive power* rating at nominal *voltage* and at nominal *active power* output; and
 - (5) providing *reactive* current compensation settable for droop or remote point voltage control.
- (b) *Synchronous generating units* commissioned after the *Rules commencement date* must be fitted with fast acting *excitation control systems* utilising modern technology in accordance with *good electricity industry practice*. AC exciter, rotating rectifier or *static excitation systems* must be provided for any *generating units* with a rating greater than 30 MW or for smaller *generating units* within a *power station* with a total *active power* output capability in excess of 30 MW. *Excitation control systems* must provide *voltage* regulation to within 0.5% of the selected set point value.
- (c) New non-synchronous *generating units* must be fitted with fast acting *voltage* and / or *reactive power control systems*, which must utilise modern technology and be approved by the *Network Service Provider*. *Control systems* must provide regulation to within 0.5% of the selected set point value.
- (d) *Synchronous generating units* commissioned after the *Rules commencement date* with ratings in excess of 30 MW or smaller *generating units* within a *power station* with a total *active power* output capability in excess of 30 MW must incorporate *power system* stabiliser (PSS) circuits which modulate the *generating unit* field *voltage* in response to *changes* in power output and/or shaft speed and/or any other equivalent input signal approved by the *Network Service Provider*. The stabilising circuits must be responsive and adjustable over a *frequency* range which must include *frequencies* from 0.1 Hz to 2.5 Hz. *Power system* stabiliser circuits may be required on *synchronous generating units* with ratings less than or equal to 30 MW or smaller *synchronous generating units* within a *power station* with a total *active power* output capability less than or

equal to 30 MW if *power system* simulations indicate a need for such a requirement. Before commissioning of any *power system* stabiliser, the *Generator* must propose preliminary settings for the *power system* stabiliser, which must be approved by the *Network Service Provider*

- (e) Power system stabilisers may also be required for non-synchronous *generating units*. The performance characteristics of these *generating units* with respect to power system stability must be similar to those required for *synchronous generating units*. The requirement for a power system stabiliser and its structure and settings will be determined by the *Network Service Provider* from *power system* simulations.
- (f) The performance characteristics required for AC exciter, rotating rectifier and *static excitation systems* are specified in Table 3.1:

Table 3.1 Synchronous Generator Excitation System Performance Requirements

Performance Item	Units	Static Excitation	AC Exciter or Rotating Rectifier	Notes
<p>Sensitivity:</p> <p>A sustained 0.5% error between the <i>voltage</i> reference and the sensed <i>voltage</i> must produce an excitation <i>voltage change</i> of not less than 1.0 per unit.</p>	Open loop gain (ratio)	200 minimum	200 minimum	1
<p>Field <i>voltage</i> rise time:</p> <p>Time for field <i>voltage</i> to rise from rated <i>voltage</i> to excitation ceiling <i>voltage</i> following the application of a short duration impulse to the <i>voltage</i> reference.</p>	second	0.05 maximum	0.5 maximum	2, 4
<p>Settling time with the <i>generating unit</i> unsynchronised following a disturbance equivalent to a 5% step <i>change</i> in the sensed <i>generating unit</i> terminal <i>voltage</i>.</p>	second	1.5 maximum	2.5 maximum	3

SECTION 3 – TECHNICAL REQUIREMENTS OF USER FACILITIES

Settling time with the <i>generating unit</i> synchronised following a disturbance equivalent to a 5% step change in the sensed <i>generating unit</i> terminal <i>voltage</i> . Must be met at all operating points within the <i>generating unit</i> capability.	second	2.5 maximum	5 maximum	3
Settling time following any disturbance which causes an excitation limiter to operate.	second	5 maximum	5 maximum	3

Notes:

1. One per unit excitation *voltage* is that field *voltage* required to produce nominal *voltage* on the air gap line of the *generating unit* open circuit characteristic (Refer IEEE Standard 115-1983 - Test Procedures for Synchronous Machines). *Excitation control system* with both proportional and integral actions must achieve a minimum equivalent gain of 200.
 2. Rated field *voltage* is that *voltage* required to give nominal *generating unit* terminal *voltage* when the *generating unit* is operating at its maximum continuous rating. Rise time is defined as the time taken for the field *voltage* to rise from 10% to 90% of the increment value.
 3. Settling time is defined as the time taken for the *generating unit* terminal *voltage* to settle and stay within an error band of $\pm 10\%$ of its increment value.
 4. Field *voltage* means *generating unit* field *voltage*.
- (g) The performance characteristics required for the *voltage* or *reactive power control systems* of all non-synchronous *generating units* are specified in Table 3.2:

Table 3.2 Non-Synchronous Generator Voltage or Reactive Power Control System Performance Requirements

Performance Item	Units	Limiting Value	Notes
<p>Sensitivity:</p> <p>A sustained 0.5% error between the reference <i>voltage</i> and the sensed <i>voltage</i> must produce an output change of not less than 100% of the <i>reactive power generation</i> capability of the <i>generating unit</i>, measured at the point of control.</p>	Open loop gain (ratio)	200 minimum	1

<p>Rise time:</p> <p>Time for the controlled parameter (<i>voltage</i> or <i>reactive power</i> output) to rise from the initial value to 90% of the change between the initial value and the final value following the application of a 5% step change to the <i>control system</i> reference.</p>	second	1.5 maximum	2
<p>Small disturbance settling time</p> <p>Settling time of the controlled parameter with the <i>generating unit</i> connected to the <i>transmission or distribution network</i> following a step change in the <i>control system</i> reference that is not large enough to cause saturation of the controlled output parameter. Must be met at all operating points within the <i>generating unit's</i> capability.</p>	second	2.5 maximum	3
<p>Large disturbance settling time</p> <p>Settling time of the controlled parameter following a large disturbance, including a <i>transmission or distribution network</i> fault, which would cause the maximum value of the controlled output parameter to be just exceeded.</p>	second	5 maximum	3

Notes:

1. A control system with both proportional and integral actions must be capable of achieving a minimum equivalent gain of 200.
 2. The controlled parameter and the point where the parameter is to be measured must be agreed and included in the relevant *connection agreement*.
 3. Settling time is defined as the time taken for the *controlled parameter* to settle and stay within an error band of $\pm 10\%$ of its increment value.
- (h) The structure and parameter settings of all components of the *control system*, including the *voltage* regulator, *reactive power* regulator, *power system* stabiliser, power amplifiers and all excitation limiters, must be approved by the *Network Service Provider*.
- (i) The structure and settings of the *voltage / excitation control system* must not be *changed*, corrected or adjusted in any manner without the prior written approval of the *Network Service Provider*.

- (j) Control system settings may require alteration from time to time as advised by the *Network Service Provider*. The preliminary settings backed up by any calculations and system studies to derive these settings must be provided by the *Network Service Provider* at least two *months* before the system tests stated in clause 4.1.3 are undertaken. A *Generator* must cooperate with the *Network Service Provider* by applying the new settings and participating in tests to demonstrate their effectiveness.
- (k) Excitation limiters must be provided for under excitation and over excitation of *synchronous generating units* and may be provided for *voltage to frequency* ratio. The *generating unit* must be capable of stable operation for indefinite periods while under the control of any limiter. Limiters must not detract from the performance of any stabilising circuits and must have settings applied which are coordinated with all *protection systems*.

3.3.5 *Power station Auxiliary Transformers*

In cases where a *power station* takes its auxiliary supplies through a *transformer* by means of a separate *connection point*, the *User* must comply with the conditions for *connection of loads* (refer to clause 3.4) in respect of that *connection point*.

3.3.6 *Synchronising*

- (a) For a *synchronous generating unit* the *Generator* must provide and install manual or automatic synchronising at the *generating unit* circuit breakers.
- (b) The *Generator* must provide check synchronising on all *generating unit* circuit breakers and any other circuit breakers, unless interlocked (as outlined in clause 3.4), that are capable of connecting the *User's* *generating equipment* to the *transmission or distribution system*.
- (c) Prior to the initial *synchronisation* of the *generating unit(s)* to the *transmission or distribution transmission system*, the *Generator* and the *Network Service Provider* must agree on written operational procedures for *synchronisation*.

3.3.7 *Secure Electricity Supplies*

A *Generator* must provide secure electricity supplies of adequate capacity for the operation of *equipment* performing metering, communication, monitoring, and *protection* functions for at least 8 hours after the loss of AC supplies to that *equipment*.

3.3.8 *Design Requirements For Generator's Substations*

A *Generator* must comply with the requirements of clause 3.4.8.

3.3.9 *Computer Model*

- (a) A *Generator* must provide a software model of each *generating unit* suitable for use in the software package which is used by the *Network Service Provider* at the time of signing the relevant *connection agreement*. The model must

automatically initialise its parameters from *load* flow simulations. Once a simulation case has been compiled, *changes* in the *load* flow such as *changes* in *voltage*, *generating unit* output, *voltage* set point must not require the study case to be recompiled. It is the preference of the *Network Service Provider* that the model be made available to the provider for inclusion in the standard software package library. The source code of the model must also be provided.

- (b) *Generators* must demonstrate to the satisfaction of the *Network Service Provider* that the model adequately represents the performance of the *generating unit* over its *load* range and over the system *frequency* operating range of clause 2.2.1, [Table 2.1](#). The normal method of model verification is through testing.
- (c) The structure and parameter settings of all components of the turbine and excitation control *equipment* must be provided to the *Network Service Provider* in sufficient detail to enable the dynamics of these components to be characterised in the computer model for short and long term simulation studies. This must include a control block diagram in suitable form to perform dynamic simulations and proposed and final parameter settings for the turbine and *excitation control systems* for all expected modes of *turbine control system* operation. The final parameter settings must not be varied without prior approval of the *Network Service Provider*.
- (d) The applicable structure and parameter settings include:
 - (1) speed/*load controller*;
 - (2) key *protection* and control loops;
 - (3) actuators (for example hydraulic valve positioning systems); and
 - (4) limiters.
- (e) A *Generator* may connect to the *transmission or distribution system* without fully complying with the requirements of subclauses (a) to (d) of this clause 3.3.9 provided that the *Generator* agrees in the relevant *connection agreement* to alternative arrangements, acceptable to the *Network Service Provider*, for the provision of a compatible software model of the *generating unit* should the *Network Service Provider* upgrade or change its *power system* simulation software.
- (f) A *Generator* that was connected to the *transmission or distribution system* prior to the *rules commencement date*, and which has not fully complied with the requirements of subclauses (a) to (d) of this clause 3.3.9, must support the computer model for changes in the nominated software for the duration of its connection to the *transmission or distribution system*.

3.4 REQUIREMENTS FOR *CONNECTION OF LOADS*

3.4.1 Obligations of *Consumers*

- (a) A *Consumer* must ensure that all *facilities* associated with the relevant *connection point* at all times comply with the applicable requirements and conditions of *connection for loads*:
- (1) as set out in this clause 3.4; and
 - (2) in accordance with any relevant *connection agreement* with the *Network Service Provider*.
- (b) A *Consumer* must operate its *facilities* and *equipment* in accordance with any and all *directions* given by *System Management* or the *Network Service Provider* under these *Rules* or under any written law.

3.4.2 Overview

- (a) This clause 3.4 applies to the *connection* of *equipment* and *facilities* of *Consumers* to the *transmission and distribution systems*.
- (b) The requirements set out in this clause 3.4 generally apply to the *connection* of a large *load* to the *transmission or distribution network*. The specific requirements for the *connection* of a particular *Consumer's equipment* and *facilities* must be determined by the *Network Service Provider* and will depend on the magnitude and other characteristics of the *Consumer's load*, the *power transfer capacity*, *voltage* and location of the *connection point*, and characteristics of the local *transmission or distribution system* in the vicinity of the *connection point*.
- (c) A *Consumer* must provide *equipment capabilities*, *protection* and *control systems* that ensure that its *load*:
- (1) does not cause excessive *load* fluctuations, *reactive power* draw or, where applicable, stalling of motor *loads* that would have an adverse impact on other *Users*, *System Management*, the *Network Service Provider* or the performance of the *power system*.
 - (2) does not cause any reduction of inter-*regional* or intra-*regional power transfer capability* based on:
 - (A) *frequency stability*, or
 - (B) *voltage stability*,by more than its *loading* level whenever *connected* relative to the level that would apply if the *Consumer* were *disconnected*.

Note: this requirement is intended to safeguard from transients caused by relatively large <i>Users</i> with a high proportion of motor <i>loads</i> ; for example, to safeguard one mining operation from another.

3.4.3 Power Frequency Variations

A *Consumer* must ensure that the *equipment* connected to its *connection point* is capable of continuous uninterrupted operation (other than when the *facility* is faulted) if variations in *supply frequency* of the kind described in clause 2.2.1(c) occur.

3.4.4 Power Frequency Voltage Variations

A *Consumer* must ensure that the *equipment* connected to its *connection point* is capable of continuous uninterrupted operation (other than when the *facility* is faulted) if variations in *supply voltage* of the kind described in clause 2.2.2.

3.4.5 Provision of Information

- (a) Before *connection* to the *transmission or distribution system*, a *Consumer* must provide all data relevant to each *connection point* that is required by the *Network Service Provider* in order to complete the detailed design and installation of the relevant *connection assets*, to ensure that there is sufficient *power transfer capability* in the *transmission and distribution systems* to *supply* the *Consumer's load* and that *connection* of the *Consumer's load* will not have an adverse impact on other *Users*, or on the performance of the *power system*.
- (b) The specific data that must be provided by a *Consumer* in respect of a particular *connection point* will depend on characteristics of the *Consumer's loads*, the *power transfer capacity* of the *connection point* as specified in the relevant *connection agreement*, the *voltage* and location of the *connection point*, and characteristics of the local *transmission or distribution system* in the vicinity of the *connection point*. *Equipment* data that may need to be provided includes:
- (1) interface *protection* details including, line diagram, grading information, secondary injection and trip test certificate on all circuit breakers;
 - (2) metering system design details for *equipment* being provided by the *Consumer*;
 - (3) a general arrangement locating all the major *loads* on the site;
 - (4) a general arrangement showing all exits and the position of all electrical *equipment* in *substations* that are directly connected to the *connection point*;
 - (5) type test certificates for new switchgear and *transformers*, including measurement *transformers* to be used for metering purposes;
 - (6) the proposed methods of earthing cables and other *equipment* plus a single line earthing diagram;
 - (7) *equipment* and earth grid test certificates from approved test authorities;

- (8) operational procedures;
- (9) details of time-varying, non-sinusoidal and potentially disturbing *loads*;
- (10) SCADA arrangements;
- (11) *load* details including maximum demand profiles;
- (12) a line diagram and service or incoming cable routes and sizes; and
- (13) preferred location of the *connection point*.

Typically, a small domestic Consumer will only be required to provide the data referred to in clauses 3.4.5(b)(12) and clause 3.4.5(b)(13).

- (c) In addition to the requirements in clause 3.4.5(a) and (b), the *Consumer* must provide load data reasonably required by the *Network Service Provider*. Details of the kinds of data that may be required are included in Attachment 3 and Attachment 9.

3.4.6 Design Standards

- (a) The *equipment connected* to a *Consumer's connection point* must comply with the relevant *Australian Standards* as applicable at the time of first installation of the *equipment*, the *Electricity (Supply Standard and System Safety) Regulations 2001 (WA)*, *good electricity industry practice* and these *Rules* and it must be capable of withstanding the power frequency *voltages* and impulse levels specified by the *Network Service Provider*.
- (b) The circuit breakers, fuses and other *equipment* provided to isolate a *Consumer's facilities* from the *transmission and distribution system* in the event of a fault must be capable of breaking, without damage or restrike, the fault currents specified by the *Network Service Provider* for the relevant *connection point*.
- (c) The *equipment ratings* connected to a *Consumer's connection point* must coordinate with the *equipment* installed on the *power system*.

3.4.7 Power factor Requirements

- (a) *Power factor* ranges to be met by *loads connected* to the *transmission system* and those *connected* to the *distribution system* and rated 1MVA or more are shown in the [Table 3.3](#).

Table 3.3 Power factor Requirements (Loads)

Permissible Range	
Supply Voltage (nominal)	Power factor Range (half-hour average, unless otherwise specified by the Network Service Provider)
220kV / 330 kV	0.96 lagging to unity
66kV / 132 kV	0.95 lagging to unity
<66kV	0.9 lagging to 0.9 leading

- (b) The power factor range to be met by loads of less than 1 MVA connected to the distribution system is 0.8 lagging to 0.8 leading. Where necessary to ensure the satisfactory operation of the distribution system, a different power factor range may be specified in the relevant connection agreement.
- (c) The Network Service Provider may permit a lower lagging or leading power factor where this will not reduce system security and/or quality of supply, or require a higher lagging or leading power factor to achieve the power transfers required by the load.
- (d) A shunt capacitor installed to comply with power factor requirements must comply with the Network Service Provider's requirements to ensure that the design does not severely attenuate audio frequency signals used for load control or operations.
- (e) A static VAr compensator system installed for either power factor or quality of supply requirements must have a control system that does not interfere with other control functions on the electricity transmission and distribution system. Adequate filtering facilities must be provided if necessary to absorb any excessive harmonic currents.

3.4.8 Design Requirements for Consumers' Substations

Equipment in or for any Consumer's substation that is connected directly to a connection point must comply with the following requirements:

- (a) safety provisions that comply with the requirements of the Network Service Provider must be incorporated into the substation facilities;
- (b) where required by the Network Service Provider, interfaces and accommodation must be provided by the User for metering, communication, remote monitoring and protection equipment to be installed in the substation by the Network Service Provider;

- (c) the *substation* must be capable of continuous uninterrupted operation within the system performance standards specified in section 2.2;
- (d) the *transformer* vector group must be agreed with the *Network Service Provider*. The vector group must be compatible with the power system at the connection point and preference be given to vector groups with a zero sequence opening between high *voltage* and low *voltage* windings.
- (e) earthing of primary *equipment* in the *substation* must be in accordance with AS/NZS 3000:2000, and *Western Australian Electrical Requirements*. The earthing system must satisfy these requirements without any reliance on the *Network Service Provider's equipment*;
- (f) *synchronisation facilities* or reclose blocking must be provided if *generating units* are *connected* through the *substation*; and
- (g) insulation levels of *equipment* in the *substation* must coordinate with the insulation levels of the *transmission and distribution system* to which the *substation* is *connected* without degrading the design performance of the *transmission and distribution system*.

3.4.9 Load shedding Facilities

Consumers must provide automatic *load shedding facilities* where required by the *Network Service Provider* in accordance with clause 2.3.1(c).

3.4.9.1 Installation and Testing of Load shedding Facilities

A *Consumer* that controls a *load* subject to *load shedding* in accordance with clause 2.3.1(c) must:

- (a) provide, install, operate and maintain *equipment* for *load shedding*;
- (b) co-operate with the *Network Service Provider* in conducting periodic functional testing of the *load shedding equipment*, which must not require *load* to be *disconnected*;
- (c) apply *underfrequency* settings to relays as determined by the *Network Service Provider*; and
- (d) apply *undervoltage* settings to relays as determined by the *Network Service Provider*.

3.4.10 Monitoring and Control Requirements

3.4.10.1 Remote Monitoring

- (a) The *Network Service Provider* may require large *transmission and distribution connected Users* to:

SECTION 3 – TECHNICAL REQUIREMENTS OF USER FACILITIES

- (1) provide *remote monitoring equipment* to enable *System Management* or the *Network Service Provider* to monitor the status and indications of the *load* remotely where this is necessary in real time for management, control, planning or *security* of the *power system*; and
 - (2) upgrade, modify or replace any *RME* already installed in a *User's substation* where the existing *RME* is, in the opinion of the *Network Service Provider*, no longer fit for purpose and notice is given in writing to the relevant *Consumer*.
- (b) An *RME* provided, upgraded, modified or replaced (as applicable) in accordance with clause 3.4.10.1(a) must conform to an acceptable standard as agreed by the *Network Service Provider* and must be compatible with the *Network Service Provider's SCADA system*, including the requirements of clause 5.11.
- (c) Input information to *RME* may include the following:
- (1) status indications
 - (A) relevant circuit breakers open/closed (dual point) within the *equipment*;
 - (B) relevant isolators within the *equipment*;
 - (C) connection to the *transmission or distribution system*; and
 - (D) relevant earth switches;
 - (2) alarms
 - (A) *protection* operation;
 - (B) *protection* fail;
 - (C) battery fail - AC and DC;
 - (D) trip circuit supervision; and
 - (E) *trip supply supervision*;
 - (3) measured values
 - (A) *active power load*;
 - (B) *reactive power load*;
 - (C) *load* current; and
 - (D) relevant *voltages* throughout the *equipment*, including *voltage* on the *Network Service Provider* side of main switch.

3.4.10.2 *Network Service Provider's Communications Equipment*

Where *remote monitoring equipment* is installed in accordance with clause 3.4.10.1, the *User* must provide communications paths (with appropriate redundancy) between the *remote monitoring equipment* and a communications interface in a location reasonably acceptable to the *Network Service Provider*. Communications systems between this communications interface and the relevant *control centre* are the responsibility of the *Network Service Provider* unless otherwise agreed.

3.4.11 **Secure Electricity Supplies**

All *Users* must provide secure electricity supplies of adequate capacity to provide for the operation for at least 8 hours of *equipment* performing metering, communication, monitoring, and *protection* functions, on loss of AC supplies.

3.5 **USER'S PROTECTION REQUIREMENTS**

3.5.1 **Overview**

- (a) The requirements of this clause 3.5 apply only to a *User's protection system* that is necessary to maintain *power system security*. *Protection systems* installed solely to cover risks associated with a *User's equipment* are at the *User's* discretion. The extent of a *User's equipment* that will need to conform to the requirements of this clause 3.5 will vary from installation to installation. Consequently, each installation will need to be assessed individually by the *Network Service Provider*. Information that may be required by the *Network Service Provider* in order to complete this assessment is specified in Attachment 5.
- (b) The requirement for *protection systems* in respect of any *User's equipment* that forms an integral part of the *transmission or distribution system* (as seen from the *transmission or distribution system*) is the same as would apply under clause 2.9 if that *equipment* were the *Network Service Provider's equipment*. For the purposes of this clause 3.5.1(b) a *User's equipment* forms an integral part of the *transmission and distribution system* when the *connection asset* (such as a circuit breaker) that is used to disconnect a *User's equipment* from the *transmission or distribution system* is owned by a *User*.
- (c) All *Users'* equipment connected to the *transmission or distribution system* must be protected by *protection systems* or devices that automatically disconnect any faulty circuit from the *transmission or distribution system*.
- (d) A *User* and the *Network Service Provider* must cooperate in the design and implementation of *protection systems*, including with regard to:
 - (1) the use of *current transformer* and *voltage transformer* secondary circuits (or equivalent) of one party by the *protection system* of the other;

SECTION 3 – TECHNICAL REQUIREMENTS OF USER FACILITIES

- (2) tripping of one party's circuit breakers by a *protection system* of the other party; and
- (3) co-ordination of *protection system* settings to ensure inter-operation.

Any reliance on the *Network Service Provider's protection system* to protect an item of *User's equipment*, and vice versa, including the use of *current transformers and voltage transformers* (or equivalent) and the tripping of circuit breakers, must be included in the relevant *connection agreement*.

- (e) A *User's protection systems* must be located on the relevant *User's equipment* and must discriminate with the *Network Service Provider's protection systems* and that of other *Users*.
- (f) Except in an emergency, a *User* with *equipment* connected directly to the *transmission system* must notify the *Network Service Provider* at least 5 *business days* prior to taking out of service all or part of a *protection system* of any *equipment* operating at a nominal *voltage* of 66 kV or greater.
- (g) The installation and use of *automatic reclose equipment* in a *Consumer's facility* is permitted only with the prior written agreement of the *Network Service Provider*.
- (h) A *Consumer* must not adjust its *protection* settings without the *Network Service Provider's* approval.

3.5.2 Specific *Protection Requirements for Generator Facilities*

- (a) The requirements of this clause 3.5.2 do not apply to a *generation facility* where the total rating of all *generating units* in that generating facility is less than 10 MW and which are *connected* to the *distribution system* at a nominal *voltage* below 66 kV. For that case, the *protection system* requirements are specified in clauses 3.6 and 3.7.
- (b) The *protection system* for a *generating unit* must be designed to protect the *generating unit* from faults on the *transmission* or *distribution system* and to minimise damage to the *generating unit* from infeeds from the *transmission and distribution system* in the event of an internal fault. The *main protection system* must incorporate *two fully independent protection schemes of differing principle*, each discriminating with the *transmission and distribution system*. Where a *critical fault clearance time* exists, each *protection scheme* must be capable of operating to achieve the *critical fault clearance time*. Where there is no *critical fault clearance time* both independent *protection schemes* must meet the relevant maximum *total fault clearance times* specified in clause 2.9.4.
- (c) The design of the *two fully independent protection schemes of differing principle* must make it possible to test and maintain either *protection scheme* without interfering with the other.

- (d) The *Generator's protection system* and other controls must achieve the following functions:
- (1) disconnection of the *Generator's generation* from the *transmission and distribution systems* if any of the *protection schemes* required by clause 3.5.2(b) operate;
 - (2) separation of the *Generator's generating unit* from the *transmission and distribution systems* if there is a loss of *supply* to the *User's installation* from the *transmission and distribution systems*;
 - (3) prevention of the *Generator's generating unit* from energising de-energised *Network Service Provider equipment*, or energising and supplying an otherwise isolated portion of the *transmission or distribution system* except where a *Generator* is contracted under the Wholesale Electricity Market Rules to provide a black start *ancillary service* and is directed to provide this service by *System Management*;
 - (4) adequate *protection* of the *Generator's equipment* without reliance on back up from the *Network Service Provider's protection apparatus* except as agreed with the *Network Service Provider* in accordance with clause 3.3.3.10 or 3.5.1(d); and
 - (5) detection of a failure of a *Generator's circuit breaker* to clear a fault due to either mechanical or electrical failure. If such a failure is detected, the *Generator User's protection system* must send a trip signal to an alternative circuit breaker, which may be provided by the *Network Service Provider* in accordance with clause 3.5.1(d), in order to clear the fault.
- (e) A *Generator* must install check synchronising interlocks on all of its circuit breakers that are capable of out-of-synchronism closure, unless otherwise interlocked to the satisfaction of the *Network Service Provider*.
- (f) If a *generating unit* is connected to the *distribution system* the *Generator* must provide a circuit breaker close inhibit interlock with the feeder circuit breaker at the *Network Service Provider's zone substation* in accordance with the requirements specified by the *Network Service Provider*.

This interlock is required in addition to the islanding protection specified in clause 3.5.2(d)(3) on account of the potential safety hazard if a de-energised *distribution feeder* was energised by an *embedded generating unit*.

3.5.3 Specific *Protection Requirements for Consumer Facilities*

- (a) A *Consumer* must provide a *main protection system* to disconnect from the *power system* any faulted element within its *protection zone* within the *total fault clearance time* agreed with the *Network Service Provider* and specified in the relevant *connection agreement*. For *equipment* supplied from *connection points* with a nominal *voltage* of 33 kV or greater, the *total fault clearance times* are the

relevant times specified in clause 2.9.4 unless a *critical fault clearance time* applies in accordance with clause 2.9.5, in which case the required *total fault clearance time* is the *critical fault clearance time*.

- (b) If the *Consumer's connection point* has a nominal voltage of 66 kV or greater, the *main protection system* must:
- (1) have sufficient redundancy to ensure that a faulted element is disconnected from the *power system* within the applicable *fault clearance time* as determined in accordance with clause 3.5.3(a) with any single *protection element* (including any communications facility upon which the *protection system* depends) out of service;
 - (2) provide a *circuit breaker failure protection scheme* to clear faults that are not cleared by the circuit breakers controlled by the primary *protection system* within the applicable *fault clearance time* as determined in accordance with clause 3.5.3(a). If a circuit breaker fails, the *Consumer's protection system* may send a trip signal to a circuit breaker provided by the *Network Service Provider* in accordance with clause 3.5.1(d), in order to clear the fault.

3.6 REQUIREMENTS FOR CONNECTION OF SMALL GENERATING UNITS TO THE DISTRIBUTION NETWORK

3.6.1 Overview

This clause 3.6 addresses the particular requirements for the connection of small *generating units* and groups of small *generating units* of aggregate rated capacity up to 10 MW (small *power stations*) to the *distribution system* where such *generating units* are not subject to dispatch by *System Management* in accordance with the Wholesale Electricity Market Rules. This does not apply to the connection of energy systems rated at up to 30 kVA and connected to the *low voltage* system via inverters, in respect of which clause 3.7 applies.

The issues addressed by this clause 3.6 are:

1. the possibility that *generating units* embedded in *distribution systems* may affect the *quality of supply* to other *Users*, cause reverse *power transfer*, use up *distribution system* capacity, create a *distribution system* switching hazard and increase risks for operational personnel; and

- | | |
|----|---|
| 2. | the possibility that a small <i>power station connected to a distribution system</i> could become islanded on to a de-energised part of the <i>distribution system</i> resulting in safety and <i>quality of supply</i> concerns. |
|----|---|

3.6.2 Categorisation of *Facilities*

- (a) This clause 3.6 covers *generating units* of all types, whether using renewable or non-renewable *energy* sources.
- (b) Unless otherwise specified, technical requirements for *generating units* will apply at the *connection point*, rather than at the *generator machine* terminals, except that the *reactive power* requirements for *synchronous generating units* will apply at the *generator machine* terminals.
- (c) In this clause 3.6, *connection points* for small *power stations* are characterised as:
- (1) high *voltage connected*: 3 phase, 6.6 kV, 11 kV, 22 kV or 33 kV; or
 - (2) low *voltage connected*: 1, 2 or 3 phase plus neutral, 240V or 415V.
 - (3) Where a small *power station* is the only *facility* connected to a low *voltage* network the *Generator* may choose to have the *power station* assessed for compliance as if the *power station* was high *voltage connected*. Prior to another *User* subsequently connecting to the same low voltage network the *Network Service Provider* must reassess the *power station* for compliance with the requirements for low *voltage connected power stations* and the *Generator* must rectify any non-compliance identified in the reassessment.

(d) **Modes of Operation**

In this clause 3.6, the mode of operation of a *generating unit* in a small *power station* is characterised as:

- (1) being in continuous parallel operation with the *distribution system*, and either exporting electricity to the *distribution system* or not exporting electricity to it;
- (2) being in occasional parallel operation with the *distribution system*, and either exporting electricity to the *distribution system* or not exporting electricity to it, including *generating units* participating in peak lopping and system *peak load* management for up to 200 hours per year;
- (3) being in short term test parallel operation with the *distribution system*, and either exporting electricity to the *distribution system* or not exporting electricity to it, and having a maximum duration of parallel operation 2 hours per event and 24 hours per year; or

- (4) bumpless (make before break) transfer operation, being:
 - (A) operation in rapid transfer mode where, when *load* is transferred between the *generating unit* and the *distribution system* or vice versa, the *generating unit* is synchronised for a maximum of one second per event; or
 - (B) operation in gradual transfer mode where, when *load* is transferred between the *generating unit* and the *distribution system* or vice versa, the *generating unit* is synchronised for a maximum of 60 seconds per event.

3.6.3 Information to be provided by the *Generator*

- (a) A *Generator* must provide all information in relation to the design, construction, operation and configuration of that small *power station* as is required by the *Network Service Provider* to ensure that the operation and performance standards of the *distribution system*, or other *Users*, are not adversely affected by the operation of the *power station*. Details of the kinds of information that may be required are included in Attachment 3 and Attachment 10.
- (b) In order to assess the impact of the *equipment* on the operation and performance of the *distribution system* or on other *Users*, the *Network Service Provider* may require a *Generator* to provide data on:
 - (1) *power station* and *generating unit* aggregate real and reactive power; and
 - (2) flicker coefficients and harmonic profile of the *equipment*, where applicable and especially for wind power and inverter connected *equipment*. Data on power quality characteristics, including flicker and harmonics, in accordance with IEC 61400-21 must be provided for all wind turbines.
- (c) Net import / export data must be provided in the form of:
 - (1) a typical 24 hour power curve measured at 15 minute intervals (or better if available); and
 - (2) details of the maximum kVA output over a 60 second interval,or such other form as specified in the relevant *connection agreement*.
- (d) When requested by the *Network Service Provider*, a *Generator* must provide details of the proposed operation of the *equipment* during start-up, shut-down, normal daily operation, intermittent fuel or wind variations and under fault or *emergency conditions*.
- (e) For *generating units* in a small *power station* of aggregate rating 5 MW and above, the *Network Service Provider* must assess the need for dynamic

simulation studies and may require the *Generator* to provide a computer model in accordance with the requirements of clause 3.3.8.

3.6.4 Safety and *Reliability*

- (a) The requirements imposed on a *Generator* by this clause 3.6 are intended to provide minimum safety and *reliability* standards for the *distribution system* and other *Users*. Subject to meeting these requirements, a *Generator* must design its *facilities* in accordance with applicable standards and regulations, *good electricity industry practice* and the manufacturers' recommendations.
- (b) The safety and *reliability* of the *distribution system* and the *equipment* of other *Users* are paramount and *access applications* must be evaluated accordingly. *Generators* must not connect or reconnect to the *distribution system* if the safety and *reliability* of the *distribution system* would be placed at risk.
- (c) Where it is apparent that the operation of *equipment* installed in accordance with the requirements of this clause 3.6 may nevertheless have an adverse impact on the operation, safety or performance of the *distribution system*, or on the *quality of supply* to other *Users*, the *Network Service Provider* must consult with the *User* to reach an agreement on an acceptable solution. As a consequence, the *Network Service Provider* may require the *Generator* to test or modify its relevant *equipment*.
- (d) Unless otherwise agreed in the relevant *connection agreement*, the *Network Service Provider* may require a *Generator* not to operate *equipment* in abnormal *distribution system* operating conditions.
- (e) *Equipment* directly connected to the *connection point* of a small *power station* must be rated for the *maximum fault current* at the *connection point* specified in clause 2.5.7(b).
- (f) A *Generator* must ensure that the *maximum fault current* contribution from a *generating unit* or *small power station* is not of a magnitude that will allow the total fault current at the *connection point* to exceed the levels specified in clause 2.5.8(b) for all *distribution system* operating conditions.

3.6.5 Requirements of clause 3.3 applicable to small *power stations*

[Table 3.5](#) lists specific provisions of clause 3.3 that apply to small *power stations* in addition to the requirements of this clause 3.6.

Table 3.5 - Specific paragraphs of clause 3.3 applicable to *distribution-connected generating units* rated up to 10 MW

Clause	Requirement
--------	-------------

Clause	Requirement
3.3.3.1	<i>Reactive power capability</i>
3.3.3.3	<p><i>Generating unit response to disturbances</i></p> <p>Except that <i>power stations</i> with less than 150 kVA aggregate capacity need not comply with subclauses 3.3.3.3(c) and 3.3.3.3(g) unless directed otherwise by the <i>Network Service Provider</i>.</p>
3.3.3.8	Protection of <i>generating units</i> from <i>power system</i> disturbances
3.3.4.4	<p><i>Frequency control systems</i></p> <p>Except that <i>non-dispatchable induction generating units</i> need not comply with subclauses (a), (b), (d) and (e)(2) and f(2); and</p> <p>Except that non-synchronous power stations with less than 150 kVA aggregate capacity do not have to comply with subclauses (a), (b), (d), and (e)(2)(B).</p>
3.3.4.5	<p><i>Voltage control systems</i></p> <p>Subclause 3.3.4.5(e) does not apply; and</p> <p>For power stations with a capacity of less than 150 kVA subclause 3.3.4.5(f) is replaced with:</p> <p><i>Generating units</i> must have <i>voltage control systems</i> that ensure that the requirements of clause 3.6.8 are met at the <i>connection point</i>.</p>

3.6.6 *Generating unit characteristics*

- (a) To assist in controlling *distribution system* fault levels, *Generators* must ensure that *generating units* comply with the *Network Service Provider's* requirements relating to *minimum fault current* and *maximum fault current* contribution through a *connection point*.
- (b) If the *connection* or *disconnection* of a *User's* small *power station* causes or is likely to cause excessively high or low fault levels, this must be addressed by other technical measures specified in the relevant *connection agreement*.

3.6.7 *Connection and Operation*

3.6.7.1 *Generators' Substations*

Generators' substations through which *generating units* are *connected* to the *distribution system* must comply with the requirements of clause 3.4.8.

3.6.7.2 Main Switch

- (a) Each *facility* at which a *generating unit* in a small *power station* is *connected* to the *distribution system* must contain one main switch provided by the *User* for each *connection point* and one main switch for each *generating unit*, where a *generating unit* shares a *connection point* with other *generating units* or *loads*. For larger installations, additional *connection points* and main switches or a dedicated feeder may be required.
- (b) Switches must be automatically operated, fault current breaking and making, ganged switches or circuit breakers. The relevant *facility* may also contain similarly rated interposed paralleling switches for the purpose of providing alternative synchronised switching operations.
- (c) At each relevant *connection point* there must be a means of visible and lockable isolation and test points accessible to the *Network Service Provider's* operational personnel. This may be a withdrawable switch, a switch with visible contacts, a set of removable links or other approved means. It must be possible for the *Network Service Provider's* operational personnel to fit safety locks on the isolation point.

Low voltage *generating units* with moulded case circuit breakers and fault limiting fuses with removable links are acceptable for isolation points in accordance with subclause 3.6.7.2(c).

3.6.7.3 Synchronising

- (a) For a *synchronous generating unit* in a small *power station*, a *Generator* must provide automatic synchronising *equipment* at each *generating unit* circuit breaker.
- (b) Check synchronising must be provided on all *generating unit* circuit breakers and any other switching devices that are capable of connecting the *User's* *generating equipment* to the *distribution system* unless otherwise interlocked to the satisfaction of the *Network Service Provider*.
- (c) Prior to the initial *synchronisation* of the *generating unit(s)* to the *distribution system*, the *Generator* and the *Network Service Provider* must agree on written operational procedures for *synchronisation*.

3.6.7.4 Safe Shutdown without External Supply

A *generating unit* must be capable of being safely shut down without electricity *supply* being available from the *distribution system*.

3.6.8 Power Quality and Voltage Change

- (a) A *Generator* must ensure that the performance standards of clause 2.2 are met when a small *power station* is *connected* by it to the *distribution system*.

- (b) The step *voltage* change at the *connection point* for *connection* and *disconnection* must comply with the requirements of clause 2.2.3. These requirements may be achieved by *synchronising* individual *generating units* sequentially. On low *voltage* feeders, *voltage changes* up to 5% may be allowed in some circumstances with the approval of the *Network Service Provider*.
- (c) The steady state *voltage* rise at the *connection point* resulting from export of power to the *distribution system* must not exceed 2% and must not cause the *voltage* limits specified in clause 2.2 to be exceeded.
- (d) When operating unsynchronised, a *synchronous generating unit* in a small *power station* must generate a constant *voltage* level with balanced phase *voltages* and harmonic *voltage* distortion equal to or less than permitted in accordance with either *Australian Standard AS 1359 (1997) "General Requirements for Rotating Electrical Machines"* or a recognised relevant international standard, as agreed between the *Network Service Provider* and the *User*.

3.6.9 Remote Control, Monitoring and Communications

- (a) For *generating units* exporting 1 MW or more to the *distribution system* the *Generator* must provide for:
 - (1) tripping of the *generating unit* remotely from the *Network Service Provider's control centre*;
 - (2) a close-enable interlock operated from the *Network Service Provider's control centre*; and
 - (3) remote monitoring at the *control centre* of (signed) MW, MVAR and *voltage*.
- (b) For *generating units* exporting less than 1 MW monitoring may not be required. However, where concerns for safety and *reliability* arise that are not adequately addressed by automatic *protection systems* and interlocks, the *Network Services Provider* may require the *Generator* to provide remote monitoring and remote control of some functions in accordance with clause 3.6.9(a).
- (c) A *Generator* must provide a continuous communication link with the *Network Service Provider's control centre* for monitoring and control for *generating units* exporting 1 MW and above to the *distribution system*. For *generating units* exporting below 1 MW, non-continuous monitoring and control may be required e.g. a bi-directional dial up arrangement.
- (d) A *Generator* must have available at all times a telephone link or other communication channel to enable voice communications between a small *power station* and the *Network Service Provider's control centre*. For *generating units* exporting above 1 MW, a dedicated telephone link or other dedicated communication channel may be required.

3.6.10 *Protection*

3.6.10.1 General

- (a) A *Generator* must provide, as a minimum, the *protection* functions specified in this clause 3.6.10.1 in accordance with the aggregate rated capacity of *generating units* in a small *power station* at the *connection point*.
- (b) A *Generator's* proposed *protection system* and settings must be approved by the *Network Service Provider*, who must assess their likely effect on the *distribution system* and may specify modified or additional requirements to ensure that the performance standards specified in clause 2.2 are met, the *power transfer* capability of the *distribution system* is not reduced and the *quality of supply* to other *Users* is maintained. Information that may be required by the *Network Service Provider* prior to giving approval is specified in Attachment 5 and Attachment 10.
- (c) A *Generator's* *protection system* must clear internal plant faults and coordinate with the *Network Service Provider's* *protection system*.
- (d) The design of a *Generator's* *protection system* must ensure that failure of any *protection* device cannot result in the *distribution system* being placed in an unsafe operating mode or lead to a disturbance or safety risk to the *Network Service Provider* or to other *Users*.

This may be achieved by providing back-up *protection schemes* or designing the *protection system* to be fail-safe, e.g. to trip on failure.

- (e) All *protection apparatus* must comply with the IEC 60255 series of standards. Integrated control and *protection apparatus* may be used provided that it can be demonstrated that the *protection* functions are functionally independent of the control functions, i.e. failure or mal-operation of the control features will not impair operation of the *protection system*.

Clause 1.9.3(b) specifies the process whereby the *Rules* may be changed to include alternatives to the standards currently specified.

- (f) All small *power stations* must provide under and over voltage, under and over frequency and overcurrent *protection schemes* in accordance with the *equipment* rating.
- (g) All small *power stations* must provide earth fault protection for earth faults on the *distribution system*. All small *power stations* connected at *high voltage* must have a sensitive earth fault *protection scheme*.

The earth fault *protection scheme* may be earth fault or neutral voltage displacement (depending on the connection type).

- (h) No small *power station* may supply a de-energised *distribution system* and all small *power stations* must provide protection against abnormal *distribution system* conditions, as specified in clause 3.3.3.8, on one or more phases.

This protection against loss of external supply may be loss of mains, rate of change of frequency (ROCOF), vector surge, reverse power or directional over current.

- (i) All small *power stations* that have an export limit shall have reverse power or directional current limits set appropriate to the export limit.
- (j) All small *power stations* must have loss of AC and DC auxiliary *supply* protection, which must immediately trip all switches that depend on that *supply* for operation of their *protection*.
- (k) Where synchronisation is time limited, the small *power station* must be disconnected by an independent timer
- (l) *Generating units* that are only operated in parallel with the distribution system during *rapid bumpless transfer* must be protected by an independent timer that will *disconnect* the generating unit from if the bumpless transfer successfully completed. Automatic transfer switches must comply with AS 60947.6.2 (2004). For the avoidance of doubt generating units covered by this clause need not comply with subclauses (f) to (k) of this clause 3.6.101.

The above exemption from subclauses (f) to (k) of clause 3.6.10.1 recognises that the *rapid bumpless transfer* will be completed or the *generating unit* will be disconnected by the disconnection timer before other *protection schemes* operate. *Protection* of the *generating unit* when it is not operating in parallel with the *distribution system* is at the discretion of the *Generator*.

3.6.10.2 Pole Slipping

Where it is determined that the disturbance resulting from loss of *synchronism* is likely to exceed that permitted in clause 2.2, the *Generator* must install a pole slipping *protection scheme*.

3.6.10.3 Islanding Protection and Intertripping

- (a) For sustained parallel operation (which excludes *rapid* or *gradual bumpless transfer*), islanding *protection schemes* of two different functional types must be provided to prevent a *generating unit* energising a part of the *distribution system* that has become isolated from the remainder of the *transmission or distribution system* under all operating modes. The *Generator* must demonstrate that two different functional types of islanding *protection schemes* have been provided.
- (b) *Generating units* designed for *gradual bumpless transfer* must be protected with at least one functional type of islanding *protection scheme*.
- (c) Islanding *protection* must operate within 2 seconds to ensure disconnection before the first *distribution system* reclosing attempt (typically 5 seconds). Relay settings are to be agreed with the *Network Service Provider*.

It should be assumed that the *Network Service Provider* will always attempt to auto-reclose to restore *supply* following transient faults.

- (d) In cases where, in the opinion of the *Network Service Provider*, the risk of undetected islanding of part of the *distribution system* and the *Generator's facility* remains significant, the *Network Service Provider* may also require the installation of an intertripping link between the *Generator's* main switch(es) and the feeder circuit breaker(s) in the *zone substation* or other upstream protection device nominated by the *Network Service Provider*.

3.6.10.4 Protection of Generator's equipment

- (a) This clause 3.6.10 applies only to *protection* necessary to maintain *power system security*. A *Generator* must design and specify any additional *protection* required to guard against risks within the *Generator's facility*.
- (b) Any failure of the *Generator's* tripping supplies, *protection apparatus* or circuit breaker trip coils required under clause 3.6.10 must be alarmed within the *Generator's facility* and operating procedures put in place to ensure that prompt action is taken to remedy such failures. As an alternative to alarming, *generating unit* main switches may be tripped automatically.

3.6.11 Commissioning and Testing

The *Generator* must comply with the testing and commissioning requirements for *generating units* connected to the *distribution system* specified in Attachment 12.

3.6.12 Technical matters to be coordinated

- (a) The *Generator* and the *Network Service Provider* must agree upon the following matters in respect of each new or altered *connection*:
- (1) design at *connection point*;
 - (2) physical layout adjacent to *connection point*;
 - (3) back-up (alternative) *supply* arrangements;
 - (4) *protection* and back-up;
 - (5) control characteristics;
 - (6) communications, metered quantities and alarms;
 - (7) insulation co-ordination and lightning protection;
 - (8) fault levels and *fault clearing times*;
 - (9) switching and isolation facilities;
 - (10) interlocking arrangements;

SECTION 3 – TECHNICAL REQUIREMENTS OF USER FACILITIES

- (11) synchronising facilities;
 - (12) under *frequency load shedding* and islanding schemes; and
 - (13) any special test requirements.
- (b) As an alternative to *distribution system augmentation*, the *Network Service Provider* may require a *Generator* to provide additional *protection schemes* to ensure that operating limits and agreed import and export limits are not exceeded.

3.7 REQUIREMENTS FOR CONNECTION OF ENERGY SYSTEMS TO THE LOW VOLTAGE DISTRIBUTION SYSTEM VIA INVERTERS

3.7.1 Scope

- (a) This clause 3.7 addresses the particular requirements for the connection of energy systems to the *Network Service Provider's* low voltage *distribution system* via inverters. It covers installations rated up to 10 kVA single phase and 30 kVA three phase. For similarly rated non-inverter connected energy systems, the requirements of clause 3.6 apply.
- (b) The scope of this clause 3.7 is limited to technical conditions of connection. The *Network Service Provider* is not able to enter an energy buyback agreement directly. A *User* wishing to enter into such an agreement must apply to a participating retailer. It should also be noted that whereas this clause 3.7 covers *connection* issues for *generators* up to 30 kVA, the maximum *generator* capacity for which a retailer may be prepared to enter into an energy buyback agreement may be less than this amount.

3.7.2 Energy System Capacity

The nominal network *voltages* and maximum energy system capacities for which these requirements apply are as follows:

<u>Nominal Voltage</u>	<u>Maximum Capacity</u>
240 V single phase	10 kVA
415 V three phase	30 kVA

For simplicity, it is assumed that the full rated capacity of the inverter is capable of being exported to the *distribution system*.

3.7.3 Relevant Standards

- (a) The installation of primary energy systems must comply with the relevant *Australian Standards* and international standards.
- (b) Inverter systems must satisfy the requirements of *Australian Standard 4777* “Grid connection of energy systems via inverters” as published and revised. The following parts of this standard apply:
 - (1) AS 4777.1 – 2005 Part 1 Installation requirements.
 - (2) AS 4777.2 – 2005 Part 2 Inverter requirements.
 - (3) AS 4777.3 – 2005 Part 3 Grid protection requirements.

- (c) The term 'inverter energy system' in these *Rules* has the same meaning as in AS 4777.
- (d) A type-test report or type-test certificate from an independent and recognised certification body showing compliance of inverter plant with AS 4777.2 (2005) must be supplied to the *Network Service Provider*.
- (e) Should it be necessary to change any parameter of the *equipment* as installed and contracted, approval must be sought from *Network Service Provider*. Subsequently, the *Network Service Provider* will determine whether a revised application is required.

3.7.4 Metering Installation

The *User* must make provision for both an import and export meter. Should an additional meter be required for the export power meter, the *User* may need to install an additional meter box or rearrange the existing meter box to accommodate a second meter.

3.7.5 Safety

Installations must comply with the relevant *Australian Standards* and all statutory requirements including AS/NZS 3000, AS/NZS 5033 and the *WA Electrical Requirements*.

All electrical installation, commissioning and maintenance work wherever required must be carried out by an electrical contractor licensed under the *Electricity (Licensing) Regulations, 1991*.

3.7.5.1 Labelling of switches

The *User's* installation must display warning labels. These labels must be maintained in good order. Clause 3.7.9 outlines a minimum set of labels to be installed. If the Inverter energy system is connected to a sub board, all up-stream (i.e. towards the main switchboard) switches and switchboards must also be labelled.

3.7.5.2 Security of operational settings

Where operational settings are applied via a keypad or switches, adequate security must be employed to prevent tampering or inadvertent/unauthorised changes to these settings. A suitable lock or password system must be used. The *Network Service Provider* must approve changes to settings prior to implementation.

3.7.6 Circuit Arrangements

3.7.6.1 Schematic diagram

A durable single sided schematic-wiring diagram of the installation showing all *equipment* and switches must be affixed on the site adjacent the inverter system.

3.7.6.2 Required switches

All switches must be suitably rated for the required duty. [Figure 3.6](#) provides an example schematic diagram for connection of an energy system via an inverter to the network. The modes of operation are detailed in [Table 3.7](#).

Table 3.7 Inverter Energy System Connection Modes

User's Main Switch (CMS)	Inverter Supply Switch (ISS)	Operating Mode
OFF	OFF	All power off
OFF	ON	Supply to the User from the inverter only
ON	OFF	Inverter isolated from the Western Power network
ON	ON	Inverter connected to the network

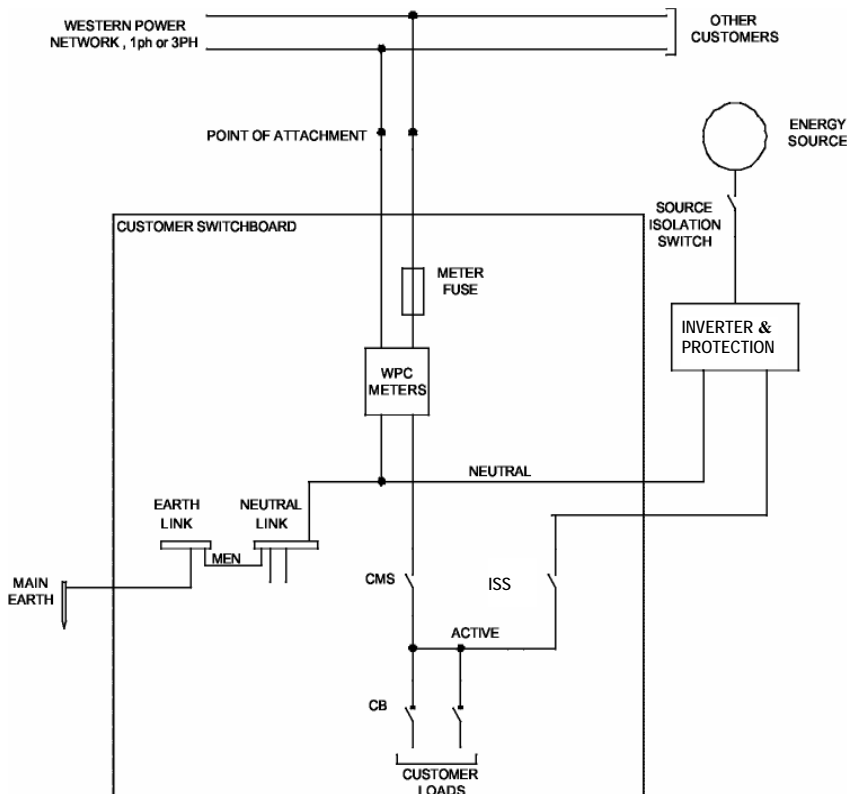

Figure 3.6 Schematic Diagram for the Connection of an Inverter Energy System

(a) Main Switch

Normal *supply* must be provided through a suitably rated electromechanical main switch that isolates the entire installation from the *distribution system*.

(b) *Inverter Supply Switch*

A suitably rated inverter supply switch is required to isolate and protect the entire Inverter energy system as shown in [Figure 3.6](#). The inverter supply switch must be lockable in the OFF position.

It is preferable for the private *generation* source to be connected at the main switchboard. If this is not possible due to distance/cost considerations, the nearest sub board may be used. See section 3.7.5.1.

(c) *Source Isolation Switch*

A Source Isolation Switch is required to isolate the energy source as shown in [Figure 3.6](#). The source isolation switch must be rated for DC operation.

3.7.7 Protection

An Inverter energy system *connected* to the *distribution system* must be approved by the *Network Service Provider* and meet the requirements of relevant standards in accordance with clause 3.7.3 and the following requirements below. The *User* must provide the information required by the *Network Service Provider* prior to approval being given.

3.7.7.1 Islanding protection

The islanding function must be automatic and must physically remove the Inverter energy system from the *distribution system*. The Islanding protection must be capable of detecting loss of *supply* from the network and disconnect the inverter energy system from the *distribution system* within 2 seconds.

3.7.7.2 Synchronising

Connection to the *distribution system* must be automated. The protective apparatus must be capable of confirming that the *supply voltage* and *frequency* is within limits for no less than one minute prior to *synchronisation*.

3.7.7.3 Reconnection to network

Reconnection to the *distribution system* must be automated. The *protective apparatus* must be capable of confirming that the *supply voltage* and *frequency* are within limits for no less than one minute prior to *synchronisation*.

3.7.7.4 Overcurrent protection

Overcurrent protection must be provided at the inverter energy system isolating switch in accordance with the *equipment* rating unless otherwise agreed with the *Network Service Provider*.

3.7.7.5 Voltage limits

The Inverter voltage limits must be set according equipment capability and AS 4777. However the Inverter energy system must remain connected for voltage variations within the limits of [Table 3.8](#) unless otherwise agreed with the *Network Service Provider*. The network *voltage* range is based on 5-minute averages of the RMS value.

Table 3.8 Low Voltage Distribution System Voltage Limits

Nominal voltage	Lower limit	Upper limit
240 V	226 V	254 V
415 V	390 V	440 V

3.7.7.6 Frequency Limits

The Inverter frequency limits must be set according equipment capability and AS 4777. However the Inverter Energy System must remain connected for frequency variations between 47.5 Hz and 52 Hz unless otherwise agreed with *Network Service Provider*.

3.7.8 Commissioning and Testing

3.7.8.1 Exclusion of clause 4.2

Where it applies, this clause 3.7.8 applies to the exclusion of clause 4.2.

3.7.8.2 Commissioning

- (a) Commissioning may occur only after the installation of the metering *equipment*.
- (b) In commissioning *equipment* installed under this clause 3.7, a *User* must verify that:
 - (1) The approved schematic has been checked and accurately reflects the installed electrical system.
 - (2) All required switches present and operate correctly as per the approved schematic.
 - (3) Signage and labelling comply with that specified in clause 3.7.9.
 - (4) The installation is correct and fit for purpose.
 - (5) Operational settings are secure as specified.
 - (6) The islanding *protection* operates correctly and disconnects the Inverter energy system from the network within 2 seconds.
 - (7) The delay in reconnection following restoration of normal supply is greater than 1 minute.

- (c) Subsequent modifications to the inverter installation must be submitted to the *Network Service Provider* for approval.

3.7.8.3 Re-confirmation of correct operation

- (a) The *Network Service Provider* may elect to inspect the proposed installation from time to time to ensure continued compliance with these requirements. In the event that the *Network Service Provider* considers that the installation poses a threat to safety, to *quality of supply* or to the integrity of the *distribution system* it may *disconnect* the *generating equipment*.
- (b) Inverter protection systems must also be tested for correct functioning at regular intervals not exceeding 5 years. The User must arrange for a suitably qualified person to conduct the tests. Results of tests must be certified by a competent person and supplied to the *Network Service Provider*.

3.7.9 Signage Guide

[Table 3.9](#) provides examples of signage required at the various locations. Note that words in italics would change to describe the type of *generation*.

Table 3.9 Examples of required signage

<p>Main switchboard and distribution board(s) upstream of distribution board where the Inverter energy system Is Connected.</p> <p>Lettering: 4 mm, 8 mm "WARNING"</p> <p>Colour: red, white letters</p> <p>Size: 120*60mm</p>	<div style="border: 1px solid black; padding: 10px; text-align: center;"> <p>WARNING</p> <p><i>SOLAR</i> GENERATION PLANT CONNECTED</p> <p>ISOLATE <i>SOLAR</i> GENERATION</p> </div>
<p>Main switchboard or distribution board where the Inverter energy system is connected.</p> <p>Lettering: 4 mm, 8 mm "WARNING"</p> <p>Colour: red, white letters</p> <p>Size: 120*60mm</p>	<div style="border: 1px solid black; padding: 10px; text-align: center;"> <p>WARNING</p> <p>DUAL SUPPLY ISOLATE BOTH NORMAL AND <i>SOLAR</i> SUPPLIES BEFORE WORKING ON THIS SWITCHBOARD</p> </div>
<p>Main Switch</p> <p>Lettering: 5 mm</p> <p>Colour: white, black letters</p>	<div style="border: 1px solid black; padding: 10px; text-align: center;"> <p>NORMAL SUPPLY MAIN SWITCH</p> </div>

<p>Size: 75 * 30mm</p>	
<p>Inverter Supply Switch</p> <p>Lettering: title 5 mm, words 4 mm Colour: white, black letters</p> <p>Size: 75 * 30 mm</p>	<div style="border: 1px solid black; padding: 10px; text-align: center;"> <p>SOLAR SUPPLY MAIN SWITCH</p> <p>SOLAR GENERATOR LOCATED IN <i>(Location of solar Generator)</i></p> </div>

4. INSPECTION, TESTING, COMMISSIONING, *DISCONNECTION* AND *RE CONNECTION*

4.1 INSPECTION AND TESTING

4.1.1 Right of Entry and Inspection

- (a) The *Network Service Provider*, *System Management* or any *User* whose *equipment* is connected directly to the *transmission system* and who is bound by these *Rules* (a reference to any of whom, for the purposes of this clause 4.1.1, includes its *representatives*) (in this clause 4.1.1 the "inspecting party") may, in accordance with this clause 4.1.1, enter and inspect any *facility* of the *Network Service Provider* or any *User* whose *equipment* is connected directly to the *transmission system* and who is bound by these *Rules* (in this clause 4.1.1 the "*facility owner*") and the operation and maintenance of that *facility* in order to:
- (1) assess compliance by the *facility owner* with its obligations under the *Access Code* or these *Rules*, or any relevant *connection agreement*;
 - (2) investigate any operating incident in accordance with clause 5.7.3;
 - (3) investigate any potential threat by that *facility* to *power system security*; or
 - (4) conduct any periodic familiarisation or training associated with the operational requirements of the *facility*.
- (b) If an inspecting party wishes to inspect a *facility* under clause 4.1.1(a), the inspecting party must give the *facility owner* at least:
- (1) 2 *business days'* notice or as otherwise agreed by the parties, or
 - (2) 10 *business days'* notice for a non-urgent issue,
- in writing of its intention to carry out an inspection.
- (c) In the case of an emergency condition affecting the *transmission or distribution system* which the *Network Service Provider* or *System Management* reasonably considers requires access to a *facility*, prior notice to the *facility owner* is not required. However, the *Network Service Provider* or *System Management*, as applicable, must notify the *facility owner* as soon as practicable of the nature and extent of the activities it proposes to undertake, or which it has undertaken, at the *facility*.
- (d) A notice given by an inspecting party under clause 4.1.1(b) must include the following information:
- (1) the name of the inspecting party's *representative* who will be conducting the inspection;

- (2) the time when the inspection will commence and the expected time when the inspection will conclude; and
 - (3) the relevant reasons for the inspection.
- (e) An inspecting party must not carry out an inspection under this clause 4.1.1 within 6 *months* of any previous inspection by it, except for the purpose of verifying the performance of corrective action claimed to have been carried out in respect of a non-conformance observed and documented on the previous inspection or, in the case of the *Network Service Provider* or *System Management*, for the purpose of investigating an operating incident in accordance with clause 5.7.1.
- (f) At any time when the *representative* of an inspecting party is in a facility owner's *facility*, that *representative* must:
 - (1) not cause any damage to the *facility*;
 - (2) interfere with the operation of the *facility* only to the extent reasonably necessary and as approved by the *facility* owner (such approval not to be unreasonably withheld or delayed);
 - (3) observe "permit to test" access to site and clearance protocols applicable to the *facility*, provided that these are not used by the *facility* owner or any contractor or agent of the *facility* owner solely to delay the granting of access to the *facility* or its inspection;
 - (4) observe the requirements in relation to occupational health and safety and industrial relations matters which are of general application to all invitees entering on or into the *facility*, provided that these requirements are not used by the *facility* owner or any contractor or agent of the *facility* owner solely to delay the granting of access to the *facility*; and
 - (5) not ask any question other than as may be reasonably necessary for the purpose of such inspection, nor give any *direction* or instruction to any person involved in the operation or maintenance of the *facility* other than in accordance with these *Rules* or, where the inspecting party and the *facility* owner are parties to a *connection agreement*, that *connection agreement*.
- (g) Any *representative* of an inspecting party conducting an inspection under this clause 4.1.1 must be appropriately qualified and experienced to perform the relevant inspection. If so requested by the *facility* owner, the inspecting party must procure that its *representative* (if not a direct employee of the inspecting party) enters into a confidentiality undertaking in favour of the *facility* owner in a form reasonably acceptable to the *facility* owner prior to seeking access to the relevant *facility*.

- (h) An inspection under this clause 4.1.1(a) must not take longer than one *day* unless the inspecting party seeks approval from the *facility* owner for an extension of time (which approval must not be unreasonably withheld or delayed).
- (i) Any *equipment* or goods installed or left on land or in premises of a *facility* owner after an inspection conducted under this clause 4.1.1 do not become the property of the *facility* owner (notwithstanding that they may be annexed or affixed to the land on which the *facility* is situated).
- (j) In respect of any *equipment* or goods left by an inspecting party on land or in premises of a *facility* owner during or after an inspection, the *facility* owner must, and must procure that any person who owns or occupies the land on which the *facility* is situated or any part thereof does:
 - (1) take reasonable steps to ensure the security of any such equipment;
 - (2) not use any such *equipment* or goods for a purpose other than as contemplated in these *Rules* without the prior written approval of the inspecting party;
 - (3) allow the inspecting party to remove any such *equipment* or goods in whole or in part at a time agreed with the *facility* owner, which agreement must not be unreasonably withheld or delayed; and
 - (4) not create or cause to be created any mortgage, charge or lien over any such *equipment* or goods.

4.1.2 Right of Testing

- (a) If the *Network Service Provider* or any *User* whose *equipment* is connected directly to the *transmission system* under a *connection agreement* (in this clause 4.1.2 the "requesting party") believes that *equipment* owned or operated by, or on behalf of, the other party to the *connection agreement* (in this clause 4.1.2 the "equipment owner") may not comply with the *Access Code*, these *Rules* or the *connection agreement*, the requesting party may require testing by the *equipment* owner of the relevant *equipment* by giving notice in writing to the equipment owner accordingly.
- (b) If a notice is given under clause 4.1.2(a), the relevant test must be conducted at a reasonable time mutually agreed by the requesting party and the *equipment* owner and, where the test may have an impact on the *security* of the *power system*, *System Management*. Such agreement must not be unreasonably withheld or delayed.
- (c) An *equipment* owner who receives a notice under clause 4.1.2(a) must co-operate in relation to conducting the tests requested by that notice.
- (d) Tests conducted in respect of a *connection point* under this clause 4.1.2 must be conducted using test procedures agreed between the *Network Service Provider*,

the relevant *Users* and, where appropriate, *System Management*, which agreement must not be unreasonably withheld or delayed.

- (e) Tests under this clause 4.1.2 may be conducted only by persons with the relevant skills and experience.
- (f) A requesting party may appoint a *representative* to witness the test requested by it under this clause 4.1.2 test and the *equipment* owner must permit a *representative* so appointed to be present while the test is being conducted.
- (g) Subject to clause 4.1.2(h), an *equipment* owner who conducts a test must submit a report to the requesting party and, where the test was one which could have had an impact on the *security* of the *power system*, *System Management*, within a reasonable period after the completion of the test. The report must outline relevant details of the tests conducted, including, but not limited to, the results of those tests.
- (h) The *Network Service Provider* may attach test *equipment* or *monitoring equipment* to *equipment* owned by a *User* or require a *User* to attach such test *equipment* or *monitoring equipment*, subject to the provisions of clause 4.1.1 regarding entry and inspection. The data from any such test *equipment* or *monitoring equipment* must be read and recorded by the *equipment* owner.
- (i) In carrying out monitoring under clause 4.1.2(i), the *Network Service Provider* must not cause the performance of the monitored *equipment* to be constrained in any way.
- (j) If a test under this clause 4.1.2 or monitoring under clause 4.1.2(i) demonstrates that *equipment* does not comply with the *Access Code*, these *Rules* or the relevant *connection agreement*, then the *equipment* owner must:
 - (1) promptly notify the requesting party of that fact;
 - (2) promptly advise the requesting party of the remedial steps it proposes to take and the timetable for such remedial work;
 - (3) diligently undertake such remedial work and report at *monthly* intervals to the requesting party on progress in implementing the remedial action; and
 - (4) conduct further tests or monitoring on completion of the remedial work to confirm compliance with the relevant requirement.

4.1.3 Tests to Demonstrate Compliance with Connection Requirements for *Generators*

- (a) (1) A *Generator* must provide evidence to the *Network Service Provider* that each of its *generating units* complies with the technical requirements of clause 3.3, 3.6 or 3.7, as applicable, and the relevant *connection agreement* prior to commencing commercial operation. In addition, each *Generator* must cooperate with the *Network Service*

Provider and, if necessary, *System Management* in carrying out *power system* tests prior to commercial operation in order to verify the performance of each *generating unit*, and provide information and data necessary for computer model validation. The test requirements for *synchronous generating units* are detailed in [Table A11.1](#) of Attachment 11. The *Network Service Provider* must specify test requirements for non-synchronous *generation*.

- (2) Special tests may be specified by the *Network Service Provider* or *System Management* where reasonably necessary to confirm that the *security* and performance standards of the *power system* and the quality of service to other *Users* will not be adversely affected by the connection or operation of a *Generator's equipment*. The requirement for such tests must be determined on a case by case basis and the relevant *Generator* must be advised accordingly. Examples of these special tests are listed in [Table A11.2](#) of 01. Where testing is not practicable in any particular case, the *Network Service Provider* may require the *Generator* to install recording *equipment* at appropriate locations in order to monitor *equipment* performance.
- (3) These compliance tests must only be performed after the machines have been tested and certified by a Chartered Professional Engineer with National Professional Engineers' Register standing qualified in a relevant discipline, unless otherwise agreed, and after the machine's turbine controls, AVR, excitation limiters, *power system* stabiliser, and associated *protection* functions have been calibrated and tuned for commercial operation to ensure stable operation both on-line and off-line. All final settings of the AVR, PSS and excitation limiters must be indicated on control transfer block diagrams and made available to the *Network Service Provider* before the tests.
- (4) A *Generator* must forward test procedures for undertaking the compliance tests required in respect of its *equipment*, including details of the recorders and measurement *equipment* to be used in the tests, to the *Network Service Provider* for approval 30 *business days* before the tests or as otherwise agreed. The *Generator* must provide all necessary recorders and other measurement *equipment* for the tests.
- (5) A *Generator* must also coordinate the compliance tests in respect of its *equipment* and liaise with all parties involved, including the *Network Service Provider* and *System Management*. The *Network Service Provider* or *System Management* may witness the tests and must be given access to the site for this purpose, but responsibility for carrying out the tests remains with the *Generator*.
- (6) All test results and associated relevant information including final transfer function block diagrams and settings of automatic *voltage* regulator, *power system* stabiliser, under excitation limiter and over

excitation limiter must be forwarded to the *Network Service Provider* within 10 *business days* after the completion of the test.

- (b) A *Generator* must negotiate in good faith with the *Network Service Provider* and agree on a compliance monitoring program, following commissioning, for each of its *generating units* to confirm ongoing compliance with the applicable technical requirements of clause 3.3, 3.6 or 3.7, as applicable, and the relevant *connection agreement*. The negotiations must consider the use of high speed data recorders and similar non-invasive methods for verifying the *equipment* performance to the extent that such non-invasive methods are practicable.
- (c) If compliance testing or monitoring of in-service performance demonstrates that a *generating unit* is not complying with one or more technical requirements of clause 3.3 and the relevant *connection agreement* then the *Generator* must:
- (1) promptly notify the *Network Service Provider* and, where relevant, *System Management* of that fact;
 - (2) promptly advise the *Network Service Provider* and, where relevant, *System Management* of the remedial steps it proposes to take and the timetable for such remedial work;
 - (3) diligently undertake such remedial work and report at *monthly* intervals to the *Network Service Provider* on progress in implementing the remedial action; and
 - (4) conduct further tests or monitoring on completion of the remedial work to confirm compliance with the relevant technical requirement.
- (d) If the *Network Service Provider* or, where relevant, *System Management* reasonably believes that a *generating unit* is not complying with one or more technical requirements of clause 3.3, 3.6 or 3.7, as applicable, and the relevant *connection agreement*, the *Network Service Provider* or *System Management* may require the *Generator* to conduct tests within an agreed time to demonstrate that the relevant *generating unit* complies with those technical requirements and if the tests provide evidence that the relevant *generating unit* continues to comply with the technical requirement(s), whichever of the *Network Service Provider* or *System Management* that requested the test must reimburse the *Generator* for the reasonable expenses incurred as a direct result of conducting the tests.
- (e) If the *Network Service Provider* or, where relevant, *System Management*:
- (1) has reason to believe that a *generating unit* does not comply with one or more of the requirements of clause 3.3, 3.6 or 3.7, as applicable;
 - (2) has reason to believe that a *generating unit* does not comply with the requirements for *protection schemes* set out in clause 2.9, as those requirements apply to the *Generator* under clause 3.5.1(b); or

- (3) either:
- (A) does not have evidence demonstrating that a *generating unit* complies with the technical requirements set out in clause 3.3, 3.6 or 3.7, as applicable; or
 - (B) holds the opinion that there is, or could be, a threat to the *power system security or stability*,

the *Network Service Provider* or, where relevant, *System Management*, may direct the relevant *Generator* to operate the relevant *generating unit* at a particular *generated* output or in a particular mode of operation until the relevant *Generator* submits evidence reasonably satisfactory to the *Network Service Provider* or, where relevant, *System Management*, that the *generating unit* is complying with the relevant technical requirement. If such a *direction* is given orally, the *direction*, and the reasons for it, must be confirmed in writing to the *Generator* as soon as practicable after the *direction* is given.

- (f) If:
- (1) the *Network Service Provider* or, where relevant, *System Management*, gives a *direction* to a *Generator* under clause 4.1.3(e) and the *Generator* neglects or fails to comply with that *direction*; or
 - (2) the *Network Service Provider* or, where relevant, *System Management*, endeavours to communicate with a *Generator* for the purpose of giving a *direction* to a *Generator* under clause 4.1.3(e) but is unable to do so within a time which is reasonable, having regard for circumstances giving rise to the need for the *direction*,

then the *Network Service Provider* or *System Management*, as the case requires, may take such measures as are available to it (including, in the case of *System Management*, issuing an appropriate *direction* to the *Network Service Provider* to take measures) to cause the relevant *generating unit* to be operated at the required *generated* output or in the required mode, or *disconnect* the *generating unit* from the *power system*.

- (g) A *direction* under clause 4.1.3(e) must be recorded by the *Network Service Provider* or *System Management*, as applicable.
- (h) From the *Rules commencement date*, each *Generator* must maintain records and retain them for a minimum of 7 years (from the date of creation of each record) for each of its *generating units* and *power stations* setting out details of the results of all technical performance and monitoring conducted under this clause 4.1.3 and make these records available to the *Network Service Provider* or *System Management* on request.

4.1.4 Routine Testing of *Protection Equipment*

- (a) A *User* must cooperate with the *Network Service Provider* to test the operation of *equipment* forming part of a *protection scheme* relating to a *connection point* at which that *User* is *connected* to a *transmission or distribution system* and the *User* must conduct these tests:
- (1) prior to the *equipment* at the relevant *connection point* being placed in service; and
 - (2) at intervals specified in the *connection agreement* or in accordance with an asset management plan agreed between the *Network Service Provider* and the *User*.
- (b) A *User* must, on request from the *Network Service Provider*, demonstrate to the *Network Service Provider's* satisfaction the correct calibration and operation of the *User's protection* at the *User's connection point*.
- (c) The *Network Service Provider* and, where applicable, a *User*, must institute and maintain a compliance program to ensure that each of its *facilities* of the following types, to the extent that the proper operation of any such *facility* may affect *power system security* and the ability of the *power system* to meet the performance standards specified in clause 2.2, operates reliably and in accordance with its relevant performance requirements specified in section 2:
- (1) *protection systems*;
 - (2) *control systems* for maintaining or enhancing *power system* stability;
 - (3) *control systems* for controlling *voltage* or *reactive power*; and
 - (4) *control systems* for *load shedding*.
- (d) A compliance program under clause 4.1.4(c) must:
- (1) include monitoring of the performance of the *facilities*;
 - (2) to the extent reasonably necessary, include provision of periodic testing of the performance of those *facilities* upon *power system* security depends;
 - (3) provide reasonable assurance of ongoing compliance of the *power system* with the performance standards specified in clause 2.2; and
 - (4) be in accordance with *good electricity industry practice*.
- (e) The *Network Service Provider* and, where applicable, a *User*, must notify *System Management* immediately if it reasonably believes that a *facility* of the type listed in clause 4.1.4(c), and forming part of a registered *facility*, does not comply with, or is unlikely to comply with, relevant performance requirements specified in section 2.

4.1.5 Testing by *Users* of their own *Equipment* Requiring *Changes* to Agreed Operation

- (a) If a *User* proposes to conduct a test on *equipment* related to a *connection point* and that test requires a *change* to the operation of that *equipment* as specified in the relevant *connection agreement*, or if the *User* reasonably believes that the test might have an impact on the operation or performance of the *power system*, the *User* must give notice in writing to the *Network Service Provider* at least 15 *business days* in advance of the test, except in an emergency.
- (b) The notice to be provided under clause 4.1.5(a) must include:
- (1) the nature of the proposed test;
 - (2) the estimated start and finish time for the proposed test;
 - (3) the identity of the *equipment* to be tested;
 - (4) the *power system* conditions required for the conduct of the proposed test;
 - (5) details of any potential adverse consequences of the proposed test on the *equipment* to be tested;
 - (6) details of any potential adverse consequences of the proposed test on the *power system*; and
 - (7) the name of the person responsible for the coordination of the proposed test on behalf of the *User*.
- (c) The *Network Service Provider* must review the proposed test to determine whether the test:
- (1) could adversely affect the normal operation of the *power system*;
 - (2) could cause a threat to *power system security*;
 - (3) requires the *power system* to be operated in a particular way which differs from the way in which the *power system* is normally operated;
 - (4) could affect the normal metering of *energy* at a *connection point*;
 - (5) could threaten public safety; or
 - (6) could damage *equipment* at the *connection point*.
- (d) If, in the *Network Service Provider's* opinion, a test could threaten public safety, damage or threaten to damage *equipment* or adversely affect the operation, performance or *security* of the *power system*, the *Network Service Provider* may direct that the proposed test procedure be modified or that the test not be conducted at the time proposed. Where appropriate, the *Network Service*

Provider must consult with *System Management* in determining the nature of any modified test procedure or the appropriate time for the test to be conducted.

- (e) The *Network Service Provider* must advise any other *Users* who will be adversely affected by a proposed test and consider any requirements of those *Users* when approving the proposed test.
- (f) The *User* who conducts a test under this clause 4.1.5 must ensure that the person responsible for the coordination of the test promptly advises the *Network Service Provider* and, where appropriate, *System Management*, when the test is complete.
- (g) If the *Network Service Provider* approves a proposed test, the *Network Service Provider* and, where appropriate, *System Management* must ensure that *power system* conditions reasonably required for that test are provided as close as is reasonably practicable to the proposed start time of the test and continue for the proposed duration of the test.
- (h) Within a reasonable period after any such test has been conducted, the *User* who has conducted a test under this clause 4.1.5 must provide the *Network Service Provider* and, where appropriate, *System Management*, with a report in relation to that test, including test results where appropriate.

4.1.6 Tests of *Generating units* Requiring *Changes to Agreed Operation*

- (a) The *Network Service Provider* may, at intervals of not less than 12 *months* per *generating unit*, by notice to the relevant *Generator* accordingly, require the testing of any *generating unit* connected to the *transmission or distribution system* in order to determine analytic parameters for modelling purposes or to assess the performance of the relevant *generating unit*.
- (b) The *Network Service Provider* must, in consultation with the *Generator*, propose a date and time for the tests but, if the *Network Service Provider* and the *Generator* are unable to agree on a date and time for the tests, they must be conducted on the date and at the time nominated by the *Network Service Provider*, provided that:
 - (1) the tests must not be scheduled for a date earlier than 15 *business days* after notice is given by the *Network Service Provider* under clause 4.1.6(a);
 - (2) the *Network Service Provider* must ensure that the tests are conducted at the next scheduled *outage* of the relevant *generating unit* or at some other time which will minimise the departure from the *commitment* and *dispatch* that is anticipated to take place at that time; and
 - (3) in any event, the tests must be conducted no later than 9 *months* after notice is given by the *Network Service Provider* under clause 4.1.6(a).

- (c) A *Generator* must provide any reasonable assistance requested by the *Network Service Provider* in relation to the conduct of the tests.
- (d) Tests conducted under clause 4.1.6 must be conducted in accordance with test procedures agreed between the *Network Service Provider* and the relevant *Generator*. A *Generator* must not unreasonably withhold its agreement to test procedures proposed for this purpose by the *Network Service Provider*.
- (e) The *Network Service Provider* must provide to a *Generator* such details of the analytic parameters of the model derived from the tests referred to in clause 4.1.6 for any of that *Generator's* *generating units* as may reasonably be requested by the *Generator*.

4.1.7 ***Power System Tests***

- (a) Tests conducted for the purpose of either verifying the magnitude of the *power transfer capability* of the *transmission or distribution system* or investigating *power system* performance must be coordinated and approved by the *Network Service Provider*.
- (b) The tests described in clause 4.1.7(a) must be conducted, if considered necessary by the *Network Service Provider* or *System Management*, whenever:
 - (1) a new *generating unit* or *facility* or a *transmission or distribution system* development is commissioned that is calculated or anticipated to alter substantially the *power transfer capability* through the *transmission or distribution system*;
 - (2) setting *changes* are made to any *turbine control system* and *excitation control system*, including *power system* stabilisers; or
 - (3) they are required to verify the performance of the *power system* or to validate computer models.
- (c) Tests as described in clause 4.1.7(a) may be requested by *System Management* or by a *User*. In either case, the *Network Service Provider* must conduct the tests unless it reasonably considers that the grounds for requesting the test are unreasonable.
- (d) The *Network Service Provider* must notify all *Users* who could reasonably be expected to be affected by the proposed test at least 15 *business days* before any test under this clause 4.1.7 may proceed and consider any requirements of those *Users* when approving the proposed test.
- (e) Operational conditions for each test must be arranged by the *Network Service Provider* in consultation, where relevant, with *System Management*, and the test procedures must be coordinated by an officer nominated by the *Network Service Provider* who has authority to stop the test or any part of it or vary the procedure within pre-approved guidelines if it considers any of these actions to be reasonably necessary.

- (f) A *User* must cooperate with the *Network Service Provider* when required in planning and conducting *transmission and distribution system* tests as described in clause 4.1.7(a).
- (g) The *Network Service Provider*, following consultation where appropriate with *System Management*, may direct the operation of *generating units* by *Users* during *power system* tests and, where necessary, the disconnection of *generating units* from the *transmission and distribution systems*, if this is necessary to achieve operational conditions on the *transmission and distribution systems* which are reasonably required to achieve valid test results.
- (h) The *Network Service Provider* must plan the timing of tests so that the variation from *commitment* and *dispatch* that would otherwise occur is minimised and the duration of the tests is as short as possible consistent with test requirements and *power system security*.

4.2 COMMISSIONING OF USER'S EQUIPMENT

4.2.1 Requirement to Inspect and Test *Equipment*

- (a) A *User* must ensure that new or replacement *equipment* is inspected and tested to demonstrate that it complies with relevant *Australian Standards*, relevant international standards, these *Rules*, the *Access Code* and any relevant *connection agreement* and *good electricity industry practice* prior to being *connected* to a *transmission* or *distribution system*.
- (b) If a *User* installs or replaces *equipment* at a *connection point*, the *Network Service Provider* is entitled to witness the inspections and tests described in clause 4.1.1(a).

4.2.2 Co-ordination During Commissioning

- (a) A *User* seeking to connect *equipment* to a *transmission* or *distribution system* must cooperate with the *Network Service Provider* to develop procedures to ensure that the commissioning of the *connection* and *connected facility* is carried out in a manner that:
 - (1) does not adversely affect other *Users* or affect *power system security* or *quality of supply* of the *power system*; and
 - (2) minimises the threat of damage to the *Network Service Provider's* or any other *User's equipment*.
- (b) A *User* may request from the *Network Service Provider* to schedule commissioning and tests (including the relevant exchange of correspondence) at particular times that suit the project completion dates. *The Network Service Provider* must make all reasonable efforts to accommodate such a request.

4.2.3 Control and *Protection* Settings for *Equipment*

- (a) Not less than 65 *business days* (or as otherwise agreed between the *User* and the *Network Service Provider*) prior to the proposed commencement of commissioning by a *User* of any new or replacement *equipment* that could reasonably be expected to alter materially the performance of the *power system*, the *User* must submit to the *Network Service Provider* sufficient design information including proposed parameter settings to allow critical assessment including analytical modelling of the effect of the new or replacement *equipment* on the performance of the *power system*.
- (b) The *Network Service Provider* must:
 - (1) consult with other *Users* and *System Management* as appropriate; and
 - (2) within 20 *business days* of receipt of the design information under clause 4.2.3(a), notify the *User* of any comments on the proposed parameter settings for the new or replacement *equipment*.
- (c) If the *Network Service Provider's* comments include alternative parameter settings for the new or replacement *equipment*, then the *User* must notify the *Network Service Provider* within 10 *business days* that it either accepts or disagrees with the alternative parameter settings suggested by the *Network Service Provider*.
- (d) The *Network Service Provider* and the *User* must negotiate parameter settings that are acceptable to them both and if there is any unresolved disagreement between them, the matter must be determined by means of the disputes procedure provided for in clause 1.7.
- (e) The *User* and the *Network Service Provider* must co-operate with each other to ensure that adequate grading of *protection* is achieved so that faults within the *User's facility* are cleared without adverse effects on the *power system*.

4.2.4 Commissioning Program

- (a) Not less than 65 *business days* (or as otherwise agreed between the *User* and the *Network Service Provider*) prior to the proposed commencement of commissioning by a *User* of any new or replacement *equipment* that could reasonably be expected to alter materially the performance of the *power system*, the *User* must advise the *Network Service Provider* in writing of the commissioning program including test procedures and proposed test *equipment* to be used in the commissioning.
- (b) The *Network Service Provider* must, within 20 *business days* of receipt of such advice under clause 4.2.4(a), notify the *User* either that it:
 - (1) agrees with the proposed commissioning program and test procedures; or

- (2) requires *changes* in the interest of maintaining *power system security*, safety or *quality of supply*.
- (c) If the *Network Service Provider* requires *changes*, then the *Network Service Provider* and the *User* must co-operate to reach agreement and finalise the commissioning program within a reasonable period.
- (d) A *User* must not commence the commissioning until the commissioning program has been finalised and the *Network Service Provider* must not unreasonably delay finalising a commissioning program.

4.2.5 Commissioning Tests

- (a) The *Network Service Provider* and *System Management* have the right to witness commissioning tests relating to new or replacement *equipment* including remote monitoring *equipment*, *protection* and control and data acquisition *equipment*, that could reasonably be expected to alter materially the performance of the *power system* or the accurate metering of *energy* or be required for the real time operation of the *power system*.
- (b) Prior to *connection* to the *transmission or distribution system* of new or replacement *equipment* covered by clause 4.2.5(a), a *User* must provide to the *Network Service Provider* a signed written statement to certify that the inspection and tests required under clause 4.2.1(a) have been completed and that the equipment is ready to be *connected* and energised. The statement must be certified by a Chartered Professional Engineer with National Professional Engineers' Register Standing qualified in a relevant discipline.
- (c) The *Network Service Provider* must, within a reasonable period of receiving advice of commissioning tests of a *User's* new or replacement *equipment* under this clause 4.2.5, advise the *User* whether or not it:
 - (1) wishes to witness the commissioning tests; and
 - (2) agrees with the proposed commissioning times.
- (d) A *User* whose new or replacement *equipment* is tested under this clause 4.2.5 must, as soon as practicable after the completion of the relevant tests, submit to the *Network Service Provider* the commissioning test results demonstrating that a new or replacement item of *equipment* complies with these *Rules* or the relevant *connection agreement* or both to the satisfaction of the *Network Service Provider*.
- (e) If the commissioning tests conducted under this clause 4.2.5 in relation to a *User's* new or replacement item of *equipment* demonstrate non-compliance with one or more requirements of these *Rules* or the relevant *connection agreement*, then the *User* must promptly meet with the *Network Service Provider* to agree on a process aimed at achieving compliance with the relevant item in these *Rules*.

- (f) The *Network Service Provider* may direct that the commissioning and subsequent *connection* of a *User's equipment* must not proceed if the relevant *equipment* does not meet the technical requirements specified in clause 4.2.
- (g) All commissioning tests under this clause 4.2.5 must be carried out under the supervision of personnel experienced in the commissioning of *power system primary equipment* and *secondary equipment*.

4.2.6 Coordination of Protection Settings

- (a) A *User* must ensure that its *protection* settings coordinate with the existing *protection* settings of the *transmission and distribution system*. Where this is not possible, the *User* may propose revised *protection* settings, for the *transmission and distribution system* to the *Network Services Provider*. In extreme situations it may be necessary for a *User* to propose a commercial arrangement to the *Network Service Provider* to modify the *transmission or distribution system protection*. The *Network Service Provider* must consider all such proposals but it must not approve a *User's protection system* until *protection* coordination problems have been resolved. In some situations, the *User* may be required to revise the *Network Service Provider* settings or upgrade the *Network Service Provider* or other *Users' equipment*, or both.
- (b) If a *User* seeks approval from the *Network Service Provider* to apply or change a control or *protection system* setting, this approval must not be withheld unless the *Network Service Provider* reasonably determines that the changed setting would cause the *User* not to comply with the requirements of clause 3 of these *Rules*, or the *power system* not to comply with the performance standards specified in clause 2.2, or the *Network Service Provider* or some other *User* not to comply with their own *protection* requirements specified in the respective clauses 2.9 and 3.5, or the *power transfer capability* of the *transmission or distribution system* to be reduced.
- (c) If the *Network Services Provider* reasonably determines that a setting of a *User's* control system or *protection system* needs to change in order for the *User* to comply with the requirements of clause 3 of these *Rules*, or for the *power system* to meet the performance standards specified in clause 2.2, or so as not to cause the *Network Service Provider* or some other *User* to fail to comply with its own *protection* requirements specified in clause 2.9 or 3.5, as applicable, or for the *power transfer capability* of the *transmission or distribution system* to be restored, the *Network Service Provider* must consult with the *User* and may direct in writing that a setting be applied in accordance with the determination.
- (d) The *Network Service Provider* may require a test in accordance with clause 4.1.3 to verify the performance of the *User's* equipment with any new setting.

4.2.7 Approval of Proposed Protection

- (a) A *User* must not allow its plant to take supply of electricity from the *power system* without prior approval of the *Network Service Provider*.

- (b) A *User* must not change the approved *protection* design or settings without prior written approval of the *Network Service Provider*.

4.3 DISCONNECTION AND RECONNECTION

4.3.1 General

- (a) If the *Network Service Provider*, in its opinion, needs to interrupt *supply* to any *User* of the *transmission system* for reasons of safety to the public, the *Network Service Provider's* personnel, any *Users' equipment* or the *Network Service Provider's equipment*, the *Network Service Provider* must (time permitting) consult with the relevant *User* prior to executing that interruption. Such consultations are generally impracticable at the *distribution system* level, because of the large number of *Users* involved, and hence are not required in relation to interruptions to *supply* to *Users* on the *distribution system*.
- (b) The *Network Service Provider* may *disconnect Users* if the *transmission or distribution system* is operating outside the permissible limits.

4.3.2 Voluntary Disconnection

- (a) Unless agreed otherwise and specified in a *connection agreement*, a *User* must give to the *Network Service Provider* notice in writing of its intention to *disconnect a facility* permanently from a *connection point*.
- (b) A *User* is entitled, subject to the terms of the relevant *connection agreement*, to require voluntary permanent disconnection of its *equipment* from the *power system*, in which case appropriate operating procedures necessary to ensure that the disconnection will not threaten *power system security* must be implemented in accordance with clause 4.3.3.

4.3.3 Decommissioning Procedures

- (a) If a *User's facility* is to be *disconnected* permanently from the *power system*, whether in accordance with clause 4.3.2 or otherwise, the *Network Service Provider* and the *User* must, prior to such disconnection occurring, follow agreed procedures for disconnection.
- (b) The *Network Service Provider* must notify other *Users* if it reasonably believes that their rights under a *connection agreement* will be adversely affected by the implementation of the procedures for disconnection agreed under clause 4.3.3(a). The *Network Service Provider* and the *User* and, where applicable, other affected *Users* must negotiate any amendments to the procedures for disconnection or the relevant *connection agreements* that may be required.
- (c) Any disconnection procedures agreed to or determined under clause 4.3.3(a) must be followed by the *Network Service Provider* and all relevant *Users*.

4.3.4 Involuntary Disconnection

- (a) The *Network Service Provider* or *System Management* may *disconnect* a *User's facilities* from the *transmission or distribution system* or otherwise curtail the provision of services in respect of a *connection point*:
- (1) in the case of the *Network Service Provider*, where directed to do so by *System Management* or the *Independent Market Operator* in the exercise or purported exercise of a power under the Wholesale Electricity Market Rules;
 - (2) in accordance with clause 4.1.3(f);
 - (3) in accordance with clause 4.3.5;
 - (4) during an emergency in accordance with clause 4.3.6; or
 - (5) in accordance with the *User's connection agreement*.
- (b) In all cases of disconnection by the *Network Service Provider* during an emergency in accordance with clause 4.3.5, the *Network Service Provider* must provide a report to the *User* advising of the circumstances requiring such action.

4.3.5 Curtailment to Undertake Works

- (a) The *Network Service Provider* may, in accordance with *good electricity industry practice*, *disconnect* a *User's facilities* from the *transmission or distribution system* or otherwise curtail the provision of services in respect of a *connection point* (collectively in this clause 4.3.5 a “curtailment”):
- (1) to carry out planned *augmentation* or maintenance to the *transmission or distribution system*; or
 - (2) to carry out unplanned maintenance to the *transmission or distribution system* where *the Network Service Provider* considers it necessary to do so to avoid injury to any person or material damage to any property or the environment; or
 - (3) if there is a breakdown of, or damage to, the *transmission or distribution system* that affects *the Network Service Provider's* ability to provide services at that *connection point*; or
 - (4) if an event:
 - (A) that is outside the reasonable control of the *Network Service Provider*; and
 - (B) whose effect on the assets of the *Network Service Provider* or the property of any person can not, by employing *good electricity industry practice*, be prevented,

is imminent, with the result that safety requirements or the need to protect the assets of the *Network Service Provider* or any other property so require; or

- (5) to the extent necessary for the *Network Service Provider* to comply with a *written law*.
- (b) *The Network Service Provider* must keep the extent and duration of any curtailment under clause 4.3.5(a) to the minimum reasonably required in accordance with *good electricity industry practice*.
- (c) *The Network Service Provider* must notify each *User* of the *transmission system* who will or may be adversely affected by any proposed curtailment under clause 4.3.5(a) of that proposed curtailment as soon as practicable. Where it is not reasonably practicable to notify a *User* prior to the commencement of the curtailment, the *Network Service Provider* must do so as soon as reasonably practicable after its commencement.
- (d) If the *Network Service Provider* notifies a *User* of a curtailment in accordance with clause 4.3.5(c) in respect of a *connection point*, the *User* (acting reasonably and prudently) must comply with any requirements set out in the notice concerning the curtailment.

4.3.6 Disconnection During an Emergency

Where the *Network Service Provider* or *System Management* is of the opinion that it must *disconnect* a *User's facilities* during an emergency under these *Rules* or otherwise, then the *Network Service Provider* or *System Management*, as applicable, may:

- (a) request the relevant *User* to reduce the *power transfer* at the proposed point of disconnection to zero in an orderly manner and then *disconnect* the *User's facility* by automatic or manual means; or
- (b) immediately *disconnect* the *User's facilities* by automatic or manual means where, in the opinion of the *Network Service Provider* or *System Management*, as applicable, it is not appropriate to follow the procedure set out in clause 4.3.6(a) because action is urgently required as a result of a threat to safety of persons, hazard to *equipment* or a threat to *power system security*.

4.3.7 Obligation to Reconnect

The *Network Service Provider* or *System Management* must reconnect a *User's facilities* to a *transmission* or *distribution transmission system* as soon as practicable:

- (a) in the case of the *Network Service Provider*, where directed to do so by *System Management* or the *Independent Market Operator* in the exercise or purported exercise of a power under the Wholesale Electricity Market Rules;
- (b) if the breach of the *Access Code*, these *Rules* or a *connection agreement* giving rise to the disconnection has been remedied; or

- (c) if the *User* has taken all necessary steps to prevent the re-occurrence of the relevant breach and has delivered binding undertakings to the *Network Service Provider* or *System Management*, as applicable, that the breach will not re-occur.

5. TRANSMISSION AND DISTRIBUTION SYSTEM OPERATION AND COORDINATION

5.1 APPLICATION

This section 5 applies to the operation and coordination of the *Network Service Provider's* and *Users' facilities* to the extent not covered under the Wholesale Electricity Market Rules. For *Market Generators* (as defined under the Wholesale Electricity Market Rules, and generally being *Generators* the rated capacity of whose *generating system* equals or exceeds 10 MW) the rules that apply for *power system* operation and coordination are those found within the Wholesale Electricity Market Rules.

5.2 INTRODUCTION

5.2.1 Purpose and Scope of Section 5

This section 5, which applies to, and defines obligations for, the *Network Service Provider* and all *Users*, has the following aims:

- (a) to establish processes and arrangements to enable the *Network Service Provider* to plan and conduct operations within the *power system*; and
- (b) to establish arrangements for the actual *dispatch* of *generating units* and *loads* by *Users*.

5.3 POWER SYSTEM OPERATION CO-ORDINATION RESPONSIBILITIES AND OBLIGATIONS

5.3.1 Responsibilities of the *Network Service Provider* for Operation Co-ordination of the *Power System*

The *transmission system* or the *distribution system* operation co-ordination responsibilities of the *Network Service Provider* are to:

- (a) take steps to coordinate high *voltage* switching procedures and arrangements in accordance with *good electricity industry practice* in order to avoid damage to *equipment* and to ensure the safety and reliability of the *power system*;
- (b) operate all *equipment* and *equipment* under its control or co-ordination within the appropriate operational or emergency limits which are either established by the *Network Service Provider* or advised by the respective *Users*;
- (c) assess the impacts of any technical and operational *constraints* of all plant and equipment connected to the *transmission or distribution system* on the operation of the *power system*;
- (d) subject to clause 5.3.2, to *disconnect User's equipment* as necessary during emergency situations to facilitate the re-establishment of the *normal operating state* in the *power system*;

- (e) coordinate and direct any rotation of *supply* interruptions in the event of a major *supply* shortfall or disruption; and
- (f) investigate and review all major *transmission and distribution system* and *power system* operational incidents and to initiate action plans to manage any abnormal situations or significant deficiencies which could reasonably threaten safe and reliable operation of the network. Such situations or deficiencies include:
 - (1) *power system frequencies* outside those specified in the definition of *normal operating state*;
 - (2) *power system voltages* outside those specified in the definition of *normal operating state*;
 - (3) actual or potential *power system* instability; and
 - (4) unplanned or unexpected operation of major *power system equipment*.

5.3.2 The *Network Service Provider's* Obligations

- (a) The *Network Service Provider* must, in accordance with the *Access Code* (including through the provision of appropriate information to *Users* to the extent permitted by law and under these *Rules*), to fulfil its *transmission system* or the *distribution system* operation and co-ordination responsibilities in accordance with the appropriate *power system operating procedures* and *good electricity industry practice*.
- (b) The *Network Service Provider* must make accessible to *Users* such information as:
 - (1) the *Network Service Provider* considers appropriate; and
 - (2) the *Network Service Provider* is permitted to disclose,in order to assist *Users* to make appropriate market decisions related to open access to the *Network Service Provider's transmission and distribution systems* and, in doing so, the *Network Service Provider* must ensure that such information is available to those *Users* who request the information on a non-discriminatory basis.
- (c) The *Network Service Provider* must operate those parts of the *transmission and distribution system* that are not under the control of *System Management* so as to ensure that the system performance standards as specified in clause 2.2.2 are met.

5.3.3 *User* Obligations

- (a) A *User* must ensure that only appropriately qualified and competent persons operate *equipment* that is directly connected to the *transmission or distribution system* through a *connection point*.

- (b) A *User* must co-operate with any review of operating incidents undertaken by the *Network Service Provider* or *System Management* under clause 5.7.3.
- (c) A *User* must co-operate with and assist the *Network Service Provider* or *System Management* in the proper discharge of the *transmission or distribution system* operation and co-ordination responsibilities.
- (d) A *User* must operate its *facilities* and *equipment* in accordance with any *direction* given by the *Network Service Provider* or *System Management*.
- (e) A *User* must notify *System Management* or, where appropriate, the *Network Service Provider*, prior to a *generating unit* being operated in a mode (e.g. "turbine-follow" mode) where the *generating unit* will be unable to respond in accordance with clause 3.3.4.4.
- (f) Except in an emergency, a *User* must notify the *Network Service Provider* at least 5 *business days* prior to taking a *protection* of transmission plant out of service.
- (g) Except in an emergency, a *User* must notify the *Network Service Provider* at least 5 *business days* prior to taking a *protection* of distribution plant out of service if this *protection* is required to meet a *critical fault clearance time*.

5.4 CONTROL OF TRANSMISSION SYSTEM VOLTAGES

5.4.1 *Transmission and Distribution System Voltage Control*

- (a) The *Network Service Provider* must determine the adequacy of the capacity to produce or absorb *reactive power* in the control of the *transmission and distribution system voltages*.
- (b) The *Network Service Provider* must assess and determine the limits of the operation of the *transmission and distribution system* associated with the avoidance of *voltage* failure or collapse under *contingency event* scenarios. Any such determination must include a review of the *voltage stability* of the *transmission system*.
- (c) The limits of operation of the *transmission system* must be translated by the *Network Service Provider* into key location operational *voltage* settings or limits, *transmission line* capacity limits, *reactive power* production (or absorption) capacity or other appropriate limits to enable their use by the *System Management* and, where appropriate, the *Network Service Provider* in the maintenance of *power system security*.
- (d) The *Network Service Provider* must design and construct the *transmission and distribution system* such that *voltage* nominations at all *connection points* can be maintained in accordance with the technical requirements specified in section 2.

- (e) In order to meet the requirements of clause 5.4.1(d), the *Network Service Provider* must arrange the provision of *reactive power facilities* and *power system voltage stabilising facilities* through:
- (1) contractual arrangements for *ancillary services* with appropriate *Users*;
 - (2) obligations on the part of *Users* under relevant *connection agreements*; and
 - (3) provision of such *facilities* by the *Network Service Provider*.
- (f) *Reactive power facilities* arranged under clause 5.4.1(e) may include any one or more of:
- (1) *synchronous generating unit voltage controls* usually associated with *tap-changing transformers*; or *generating unit AVR* set point control (rotor current adjustment);
 - (2) *synchronous condensers* (compensators);
 - (3) *static VAr compensators* (SVC);
 - (4) *static synchronous compensators* (STATCOM);
 - (5) *shunt capacitors*;
 - (6) *shunt reactors*; and
 - (7) series capacitors.

5.4.2 *Reactive Power Reserve Requirements*

The *Network Service Provider* must ensure that sufficient *reactive power reserve* is available at all times to maintain or restore the *power system* to a *normal operating state* after the most critical *contingency event* as determined by previous analysis or by periodic contingency analysis by the *Network Service Provider*.

5.4.3 *Audit and Testing*

The *Network Service Provider* must arrange, coordinate and supervise the conduct of appropriate tests to assess the availability and adequacy of the provision of *reactive power* devices to control and maintain *power system voltages*.

5.5 *PROTECTION OF POWER SYSTEM EQUIPMENT*

5.5.1 *Power System Fault Levels*

- (a) The *Network Service Provider* must determine the maximum prospective fault levels at all *transmission system busbars* and all *zone substation supply busbars*. This determination must consider all credible *transmission system* operating

configurations and all credible *generation* patterns, but need not consider short term switching arrangements that result in, for example, the temporary paralleling of *transformers* to maintain continuity of *supply*.

- (b) The fault levels determined under clause 5.5.1(a) must be publicly available. In addition, the *Network Service Provider* must ensure that there is available to a *User*, on request, such other information as will allow the *User* to determine the maximum fault level at any of the *User's connection points*.

5.5.2 Audit and Testing

The *Network Service Provider* must coordinate such inspections and tests as the *Network Service Provider* thinks appropriate to ensure that the *protection* of the *transmission and distribution system* is adequate to protect against damage to *power system equipment and equipment*. Such tests must be performed according to the requirements of clause 4.1.

5.5.3 Power Transfer Limits

The *Network Service Provider* must not exceed the power transfer limits specified in clause 2.3.8, and they must not require or recommend action which causes those limits to be exceeded.

5.5.4 Partial *Outage* of Power *Protection systems*

- (a) Where there is an *outage* of one *protection scheme* of a *transmission element*, the *Network Service Provider* must determine, and where appropriate, advise *System Management* of, the most appropriate action to take to deal with that *outage*. Depending on the circumstances, the determination may be:
 - (1) to leave the *transmission element* in service for a limited duration;
 - (2) to take the *transmission element* out of service immediately;
 - (3) to install or direct the installation of a temporary *protection scheme*;
 - (4) to accept a degraded performance from the *protection system*, with or without additional operational measures or other temporary measures to minimise *power system* impact; or
 - (5) to operate the *transmission element* at a lower capacity.
- (b) If there is an *outage* of both *protections* on a *transmission element* and the *Network Service Provider* determines that to leave the *transmission element* in service presents an unacceptable risk to *power system security*, the *Network Service Provider* must take the *transmission element* out of service as soon as practicable and advise *System Management* and any affected *Users* immediately this action is undertaken.
- (c) The *Network Service Provider* must abide by any relevant instruction given to it by *System Management* in accordance the Wholesale Electricity Market Rules.

- (d) Any affected *User* must accept a determination made by the *Network Service Provider* under this clause 5.5.4.

5.6 POWER SYSTEM STABILITY CO-ORDINATION

5.6.1 Stability Analysis Co-ordination

The *Network Service Provider* must:

- (a) ensure that all necessary calculations associated with the stable operation of the *power system* as described in clause 2.3.7 and used for the determination of settings of *equipment* used to maintain that stability are carried out; and
- (b) coordinate those calculations and determinations.

5.6.2 Audit and Testing

The *Network Service Provider* must arrange, coordinate and supervise the conduct of such inspections and tests as it deems appropriate to assess the availability and adequacy of the devices installed to maintain *power system stability*.

5.7 POWER SYSTEM SECURITY OPERATION AND CO-ORDINATION

5.7.1 User's Advice

- (a) A *User* must promptly advise the *Network Service Provider* if the *User* becomes aware of any circumstance, including any defect in, or mal-peration of, any *protection or control system*, which could be expected to adversely effect the secure operation of the *power system*.
- (b) If the *Network Service Provider* considers the circumstances advised to it under clause 5.7.1(a) to be a threat to *power system security*, the *Network Service Provider*, in consultation as necessary with *System Management*, may direct that the *equipment* protected or operated by the relevant *protection or control system* be taken out of operation or operated in such manner as the *Network Service Provider* requires.
- (c) A *User* must comply with a *direction* given by the *Network Service Provider* under clause 5.7.1(b).

5.7.2 Managing Electricity *Supply Shortfall* Events

It is the responsibility of *System Management* under the Wholesale Electricity Market Rules to manage *supply* shortfall events arising from a shortage of *generation* or from multiple *contingency events* on the those parts of the *transmission system* under its direct control. However *supply* shortfall events may also occur as a result of *contingency events* arising within those parts of the *transmission and distribution systems* under the control of the *Network Service Provider*. In addition, the *Network Service Provider* may be required to manage the rotation of *supply* interruptions in accordance with clause 5.3.1(e).

- (a) If, at any time, there are insufficient *transmission* or *distribution supply* options available to *supply* total *load* in a *region* securely, then the *Network Service Provider* may undertake any one or more of the following:
- (1) recall of:
 - (A) a *distribution equipment outage*;
 - (B) a *transmission equipment outage* where the item of *transmission equipment* is not under the direct control of *System Management*;
 - (2) *disconnect* one or more *load connection points* as:
 - (A) the *Network Service Provider* considers necessary; or
 - (B) directed by *System Management* in accordance with the demand control measures in the Wholesale Electricity Market Rules; or
 - (3) direct a *User* to take such steps as are reasonable to reduce its *load* immediately. Any temporary *load* reduction must be such that preference in *supply* is given, where necessary, to domestic *Consumers*, then commercial *Consumers* and finally industrial *Consumers*.
- (b) A *User* must comply with a direction given under clause 5.7.2(a)(3).
- (c) If there is a major *supply* shortfall, the *Network Service Provider* must implement, to the extent practicable, *load shedding* across interconnected *regions* in the proportion and order set out in the operational plan established for that purpose under the Wholesale Electricity Market Rules.

5.7.3 Review of Operating Incidents

- (a) The *Network Service Provider* may conduct reviews of significant operating incidents or deviations from normal operating conditions in order to assess the adequacy of the provision and response of *facilities* or services, and must do so if directed by *System Management*.
- (b) A *User* must co-operate in any such review conducted by the *Network Service Provider* (including by making available relevant records and information).
- (c) A *User* must provide to the *Network Service Provider* such information relating to the performance of its *equipment* during and after particular *power system* incidents or operating condition deviations as the *Network Service Provider* reasonably requires for the purposes of analysing or reporting on those *power system* incidents or operating condition deviations.
- (d) For cases where the *Network Service Provider* or *System Management* has *disconnected* a *transmission system User*, a report must be provided by the

Network Service Provider to the *User* detailing the circumstances that required the *Network Service Provider* or *System Management* to take that action.

This requirement does not apply to the disconnection of a *User* from the *distribution system* due to the large number of *Users* involved. However, for large *Users* connected to the *distribution system*, this requirement may be included in a *connection agreement*.

- (e) The *Network Service Provider* must provide to a *User* available information or reports relating to the performance of that *User's equipment* during *power system* incidents or operating condition deviations as that *User* requests.

5.8 OPERATIONS AND MAINTENANCE PLANNING

This clause is not intended to apply to *Users* who are registered as Rule Participants under Section 2 of the Wholesale Electricity Market Rules. *Outage* planning for Rule Participants is undertaken by *System Management* in accordance with clauses 3.18 to 3.21 of the Wholesale Electricity Market Rules.

In accordance with clause A3.56 of the *Access Code*, for coordination purposes, operation, maintenance and *extension* planning and co-ordination must be performed as follows:

- (a) on or before 1 July and 1 January each year, a *User*, where so requested by the *Network Services Provider*, must provide to the *Network Service Provider*:
- (1) a maintenance schedule in respect of the *equipment* and *equipment connected* at each of its *connection points* for the following *financial year*; and
 - (2) a non-binding indicative planned maintenance plan in respect of the *equipment* and *equipment connected* at each of its *connection points* for each of the 2 *financial years* following the *financial year* to which the maintenance schedule provided under clause 5.8(a)(1) relates.
- (b) A *User* must provide the *Network Service Provider* with any information that the *Network Service Provider* requests concerning maintenance of *equipment* and *equipment connected* at the *User's connection points*.
- (c) A *User* must ensure that a maintenance schedule provided by the *User* under clause 5.8(a)(1) is complied with, unless otherwise agreed with the *Network Service Provider*.
- (d) Both a maintenance schedule and a maintenance plan must:
- (1) specify the dates and duration of planned *outages* for the relevant *equipment* which may have an impact on the *transmission system*;
 - (2) specify the work to be carried out during each such an *outage*;

- (3) be in writing in substantially the form requested by the *Network Service Provider*; and
 - (4) be consistent with *good electricity industry practice*.
- (e) If a *User* becomes aware that a maintenance schedule provided by the *User* under clause 5.8(a)(1) in respect of one of its *connection points* will not be complied with, then the *User* must promptly notify the *Network Service Provider*.

5.9 POWER SYSTEM OPERATING PROCEDURES

5.9.1 Operation of User's Equipment

- (a) A *User* must observe the requirements of the relevant *power system operating procedures*.
- (b) A *User* must operate its *equipment* interfacing with the *transmission or distribution system* in accordance with the requirements of the *Access Code*, these *Rules*, any applicable *connection agreement*, and the *Network Service Provider's* Electrical Safety Instructions and procedures.
- (c) The *Network Service Provider* may direct a *User* to place *reactive power facilities* belonging to, or controlled by, that *User* into or out of service for the purposes of maintaining *power system* performance standards specified in clause 2.2. A *User* must comply with any such direction.

5.10 POWER SYSTEM OPERATION SUPPORT

5.10.1 Remote Control and Monitoring Devices

- (a) All remote control, operational metering and monitoring devices and local circuits as described in section 3 must be installed, operated and maintained by a *User* in accordance with the standards and protocols determined and advised by the *Network Service Provider* or *System Management*.

5.10.2 Power System Operational Communication Facilities

- (a) *Users* must advise the *Network Service Provider* of its requirements for the giving and receiving of *operational communications* in relation to each of its *facilities*. The requirements which must be forwarded to the *Network Service Provider* include:
 - (1) the title of contact position;
 - (2) the telephone numbers of that position;
 - (3) the telephone numbers of other available communication systems in relation to the relevant *facility*;
 - (4) a facsimile number for the relevant *facility*; and

- (5) an electronic mail address for the relevant *facility*.
- (b) A *User* must maintain the speech communication channel installed in accordance with clause 3.3.4.3(c) or clause 3.6.9(d) in good repair and must investigate any fault within 4 hours, or as otherwise agreed with the *Network Service Provider*, of that fault being identified and must repair or procure the repair of faults promptly.
- (c) Where required by *System Management* or the *Network Service Provider* a *User* must establish and maintain a form of electronic mail facility as approved by the *Network Service Provider* for communication purposes.
- (d) The *Network Service Provider* must, where necessary for the operation of the *transmission and distribution system*, advise *Users* of nominated persons for the purposes of giving or receiving *operational communications*.
- (e) Contact details to be provided by the *Network Service Provider* in accordance with clause 5.10.2.(d) include position, telephone numbers, a facsimile number and an electronic mail address.

5.10.3 Authority of Nominated Operational Contacts

The *Network Service Provider* and a *User* are each entitled to rely upon any communications given by or to a contact designated under clause 5.10.2 as having been given by or to the *User* or the *Network Service Provider*, as the case requires.

5.10.4 Records of *Power system Operational Communication*

- (a) The *Network Service Provider* and *Users* must log each telephone *operational communication* in the form of entries in a log book which provides a permanent record as soon as practicable after making or receiving the *operational communication*.
- (b) In addition to the log book entry required under clause 5.10.4(a), the *Network Service Provider* must make a voice recording of each telephone *operational communication*. The *Network Service Provider* must ensure that when a telephone conversation is being recorded under this clause 5.10.4(b), the persons having the conversation receive an audible indication that the conversation is being recorded in accordance with relevant statutory requirements.
- (c) Records of *operational communications* must include the time and content of each communication and must identify the parties to each communication.
- (d) The *Network Service Provider* and *Users* must retain all *operational communications* records including voice recordings for a minimum of 7 years.
- (e) If there is a dispute involving an *operational communication*, the voice recordings of that *operational communication* maintained by, or on behalf of the *Network Service Provider* will constitute prima facie evidence of the contents of the *operational communication*.

5.11 NOMENCLATURE STANDARDS

- (a) A *User* must use the *nomenclature standards* for *transmission* and *distribution equipment* and apparatus as determined by the *Network Service Provider*, and use the agreed nomenclature in any *operational communications* with the *Network Service Provider*.
- (b) A *User* must ensure that name plates on its *equipment* relevant to operations at any point within the *power system* conform to the agreed nomenclature and are maintained to ensure easy and accurate identification of *equipment*.
- (c) A *User* must ensure that technical drawings and documentation provided to the *Network Service Provider* comply with the agreed nomenclature.
- (d) The *Network Service Provider* may, by notice in writing, require a *User* to *change* the existing numbering or nomenclature of *transmission* and *distribution equipment* and apparatus of the *User* for purposes of uniformity.

ATTACHMENT 1 – GLOSSARY

ATTACHMENT 1 - GLOSSARY

In these *Rules*:

- (a) a word or phrase set out in column 1 of the table below has the meaning set out opposite that word or phrase in column 2 of that table; and
- (b) a word or phrase defined in the *Act* or the *Access Code* has the meaning given in that *Act* or that Code (as the case requires), unless redefined in the table below.

<i>abnormal equipment conditions</i>	<p>Are, for the purpose of clauses 2.9 and 3.5, those conditions that prevail at a particular location in the <i>power system</i> when the following circumstances exist:</p> <ul style="list-style-type: none"> (a) the number of <i>generating units connected</i> to the <i>power system</i> is the least number normally <i>connected</i> at times of minimum <i>generation</i>; (b) there is one worst case <i>generating unit outage</i>; and (c) there are either <ul style="list-style-type: none"> (1) no more than two primary <i>equipment outages</i>; or (2) no more than one primary <i>equipment outage</i> and no more than one secondary <i>equipment outage</i>. <p>where the primary <i>equipment outage(s)</i> are those which, in combination with the other circumstances of the kind listed in paragraphs (a) to (c) of this definition then existing, lead to the lowest fault current at the particular location, or to the maximum reduction in <i>sensitivity</i> of the remaining secondary system for the fault type under consideration, or to both.</p>
<i>access arrangement</i>	The meaning given in the <i>Access Code</i> .
<i>Access Code</i>	The <i>Electricity Networks Access Code 2004</i> (WA)
<i>access contract</i>	The meaning given in the <i>Act</i> .
<i>access application</i>	The meaning given in the <i>Access Code</i> .
<i>access services</i>	The same meaning as "covered service" in the <i>Access Code</i> .
<i>accumulated synchronous time error</i>	The difference between Western Australia Standard Time and the time measured by integrating the instantaneous operating frequency of the power system.
<i>Act</i>	The <i>Electricity Industry Act 2004</i> (WA).

ATTACHMENT 1 – GLOSSARY

<i>active energy</i>	A measure of electrical <i>energy</i> flow, being the time integral of the product of <i>voltage</i> and the in-phase component of current flow across a <i>connection point</i> , expressed in watt hours (Wh) and multiples thereof.
<i>active power</i>	The rate at which <i>active energy</i> is transferred.
<i>active power capability</i>	The maximum rate at which <i>active energy</i> may be transferred from a <i>generating unit</i> to a <i>connection point</i> as specified in the relevant <i>connection agreement</i> .
<i>agreed capability</i>	In relation to a <i>connection point</i> , the capability to receive or send out <i>active power</i> and <i>reactive power</i> for that <i>connection point</i> determined in accordance with the relevant <i>connection agreement</i> .
<i>ancillary service(s)</i>	The same meaning as "covered service(s)" in the <i>Access Code</i> .
<i>applicant</i>	The meaning given in the <i>Access Code</i> .
<i>augment, augmentation</i>	The meaning given in the <i>Access Code</i> .
<i>Australian Standard (AS)</i>	The edition of a standard publication by Standards Australia (Standards Association of Australia) as at the date specified in the relevant clause or, where no date is specified, the most recent edition.
<i>Authority</i>	Means the Economic Regulation Authority established under the <i>Economic Regulation Authority Act 2003 (WA)</i> .
<i>automatic reclose equipment</i>	In relation to a <i>transmission line</i> , the <i>equipment</i> which automatically recloses the relevant line's circuit breaker(s) following their opening as a result of the detection of a fault in the <i>transmission line</i> .
<i>back-up protection system</i>	A <i>protection system</i> intended to supplement the <i>main protection system</i> in case the latter does not operate correctly, or to deal with faults in those parts of the <i>power system</i> that are not readily included in the operating zone of the <i>main protection system</i> . A <i>back-up protection system</i> may use the same circuit breakers as a <i>main protection system</i> and a <i>protection scheme</i> forming part of a <i>backup protection system</i> may be incorporated in the same <i>protection apparatus</i> as the <i>protection schemes</i> comprising the <i>main protection system</i> .
<i>black start-up equipment</i>	The <i>equipment</i> required to provide a <i>generating unit</i> with the ability to start and synchronise without using electricity supplied from the <i>power system</i> .

ATTACHMENT 1 – GLOSSARY

<i>busbar</i>	A common <i>connection point</i> in a <i>power station substation</i> or a <i>transmission or distribution system substation</i> .
<i>business day</i>	The meaning given in the <i>Access Code</i> .
<i>capacitor bank</i>	A type of electrical <i>equipment</i> used to generate <i>reactive power</i> and therefore support <i>voltage</i> levels on <i>transmission or distribution</i> lines.
<i>cascading outage</i>	The occurrence of an uncontrollable succession of <i>outages</i> , each of which is initiated by conditions (e.g. instability or overloading) arising or made worse as a result of the event preceding it.
<i>change</i>	Includes amendment, alteration, addition or deletion.
<i>circuit breaker failure</i>	A circuit breaker will be deemed to have failed if, having received a trip signal from a <i>protection scheme</i> , it fails to interrupt fault current within its design operating time.
<i>commitment</i>	The commencement of the process of starting up and synchronising a <i>generating unit</i> to the <i>power system</i> .
<i>connected</i>	The state of physical linkage to or through the <i>transmission or distribution system</i> , by direct or indirect connection, so as to have an impact on <i>power system security, reliability and quality of supply</i> .
<i>connection agreement</i>	An agreement or other arrangement between the <i>Network Service Provider</i> and a <i>User</i> , which may form part of or include an <i>access contract</i> , that specifies the technical requirements that apply in relation to the connection of a <i>User's equipment</i> to the <i>transmission or distribution system</i> .
<i>connection asset</i>	The <i>equipment</i> that allows the transfer of electricity between the electricity <i>transmission or distribution system</i> and an electrical system that is not part of that <i>transmission or distribution system</i> . This includes any <i>transformers</i> or switchgear at the point of <i>interconnection</i> (including those that operate at a nominal <i>voltage</i> of less than 66 kV) but does not include the lines and switchgear at the <i>connection point</i> that form part of the electricity <i>transmission or distribution system</i> .
<i>connection point</i>	The agreed point of <i>supply</i> established between the <i>Network Service Provider</i> and a <i>User</i> .
<i>constant P & Q loads</i>	A particular type of <i>load</i> model which does not change its respective MW and MVA _r consumption as the system voltage or frequency varies.

ATTACHMENT 1 – GLOSSARY

<i>constraint</i>	A limitation on the capability of a <i>transmission or distribution system, load</i> or a <i>generating unit</i> preventing it from either transferring, consuming or generating the level of electric power which would otherwise be available if the limitation was removed.
<i>Consumer</i>	A <i>User</i> who consumes electricity supplied through a <i>connection point</i> .
<i>contingency event</i>	An event affecting the <i>power system</i> which the <i>Network Service Provider</i> expects would be likely to involve the failure or removal from operational service of a <i>generating unit</i> or <i>transmission/distribution</i> element.
<i>control centre</i>	The <i>facility</i> used by the <i>Network Service Provider</i> for directing the minute to minute operation of the <i>power system</i> .
<i>controllable</i>	for the purpose of clause 2.2.11, means that <i>voltages</i> at all major busbars in the <i>transmission and distribution system</i> must be able to be maintained continuously at the target level notwithstanding variations in <i>load</i> or that some <i>reactive</i> sources may have reached their output limits in the post-fault steady state.
<i>controller</i>	The same meaning as "designated <i>controller</i> " in Appendix 3 of the <i>Access Code</i> .
<i>control system</i>	The means of monitoring and controlling the operation of the <i>power system</i> or <i>equipment</i> including <i>generating units connected</i> to a <i>transmission</i> or <i>distribution system</i> .
<i>converter coupled generating unit</i>	A <i>generating unit</i> that uses <i>equipment</i> that <i>changes</i> the alternating-current power produced by the <i>generating unit</i> to alternating-current power acceptable for transfer to the <i>power system</i> at a <i>connection point</i> .
<i>credible contingency event</i>	A single <i>contingency event</i> or the type specified in clause 2.3.7.1(a).
<i>critical fault clearance time</i>	The maximum <i>total fault clearance time</i> that the <i>power system</i> can withstand without one or both of the following conditions arising: (a) instability; and (b) unacceptable disturbance of <i>power system voltage</i> or <i>frequency</i> .
<i>current rating</i>	The maximum current that may be permitted to flow (under defined conditions) through a <i>transmission</i> or <i>distribution</i> line or other item of <i>equipment</i> that forms part of a <i>power system</i> .

ATTACHMENT 1 – GLOSSARY

<i>current transformer (CT)</i>	A <i>transformer</i> for use with meters or <i>protection</i> devices or both in which the current in the secondary winding is, within prescribed error limits, proportional to and in phase with the current in the primary winding.
<i>damping ratio</i>	A standard mathematical parameter that characterises the shape of a damped sine wave.
<i>decommission</i>	The act of causing a <i>generating unit</i> to cease to generating indefinitely and <i>disconnecting</i> it from a <i>transmission or distribution system</i> .
<i>direction</i>	A <i>direction</i> issued by the <i>Network Service Provider</i> or <i>System Management</i> to any <i>User</i> requiring the <i>User</i> to do any act or thing which the <i>Network Service Provider</i> or <i>System Management</i> considers necessary to maintain or re-establish <i>power system security</i> or to maintain or re-establish the <i>power system</i> in a <i>reliable</i> operating state in accordance with these <i>Rules</i> .
<i>disconnect</i>	The operation of switching <i>equipment</i> or other action so as to prevent the flow of electricity at a <i>connection point</i> .
<i>dispatchable generating unit</i>	A <i>generating unit</i> that, in its satisfactory normal operating state, is capable of closely controlling its real power output.
<i>dispatch</i>	The act of the <i>Network Service Provider</i> in committing to service all or part of the <i>generation</i> available from a <i>generating unit</i> .
<i>distribution</i>	The functions performed by a <i>distribution system</i> , including conveying, transferring or permitting the passage of electricity.
<i>distribution feeder</i>	A high voltage radial circuit forming part of the <i>distribution system</i> that is supplied from a <i>zone substation</i> .
<i>distribution system</i>	Any apparatus, equipment, plant or buildings used, or to be used, for, or in connection with, the transportation of electricity at nominal voltages of less than 66 kV and which form part of the <i>South West Interconnected Network</i> .
<i>dynamic performance</i>	The response and behaviour of networks and <i>facilities</i> which are <i>connected</i> to the networks when the <i>normal operating state</i> of the <i>power system</i> is disturbed.
<i>embedded generating unit</i>	A <i>generating unit</i> which supplies on-site <i>loads</i> or <i>distribution system loads</i> and is <i>connected</i> either indirectly (i.e. by means of the <i>distribution system</i>) or directly to the <i>transmission system</i> .

ATTACHMENT 1 – GLOSSARY

<i>emergency conditions</i>	The operating conditions applying after a significant <i>transmission system</i> element has been removed from service other than in a planned manner.
<i>energisation</i>	The act or process of operating switching <i>equipment</i> or starting up <i>generating unit</i> , which results in there being a non-zero <i>voltage</i> beyond a <i>connection point</i> or part of the <i>transmission system</i> or the <i>distribution system</i> .
<i>energy</i>	Active <i>energy</i> or <i>reactive energy</i> , or both.
<i>equipment</i>	A device used in generating, transmitting or utilising electrical <i>energy</i> or making available electric power.
<i>essential services</i>	Essential services include, but are not necessarily limited to, services such as hospitals and railways where the maintenance of a supply of electricity is necessary for the maintenance of public health, order and safety.
<i>excitation control system</i>	In relation to a <i>generating unit</i> , the automatic <i>control system</i> that provides the field excitation for the <i>generating unit</i> of the <i>generating unit</i> (including excitation limiting devices and any <i>power system stabiliser</i>).
<i>extension</i>	An <i>augmentation</i> that requires the connection of a power line or <i>facility</i> to the <i>transmission or distribution system</i> .
<i>facility</i>	An installation comprising <i>equipment</i> and associated apparatus, buildings and necessary associated supporting resources used for or in connection with generating, conveying, transferring or consuming electricity, and includes: <ul style="list-style-type: none"> (a) a <i>power station</i>; (b) a <i>substation</i>; (c) <i>equipment</i> by which electricity is consumed; and (d) a <i>control centre</i>.
<i>fault clearance time</i>	The time interval between the occurrence of a fault and the fault clearance.
<i>financial year</i>	A period of 12 <i>months</i> commencing on 1 July.
<i>frequency</i>	For alternating current electricity, the number of cycles occurring in each second, measured in Hz.
<i>frequency operating standards</i>	The standards which specify the <i>frequency</i> levels for the operation of the <i>power system</i> set out clause 2.2.

ATTACHMENT 1 – GLOSSARY

<i>frequency stability</i>	The ability of a <i>power system</i> to attain a steady <i>frequency</i> following a severe system disturbance that has resulted in a severe imbalance between <i>generation</i> and <i>load</i> . Instability that may result occurs in the form of sustained <i>frequency</i> swings leading to tripping of <i>generating units</i> or <i>loads</i> or both.
<i>generated</i>	In relation to a <i>generating unit</i> , the amount of electricity produced by the <i>generating unit</i> as measured at its terminals.
<i>generating equipment</i>	In relation to a <i>connection point</i> , includes all <i>equipment</i> involved in generating electrical <i>energy</i> transferred at that <i>connection point</i> .
<i>generating system</i>	A system comprising one or more <i>generating units</i> .
<i>generating unit</i>	The <i>equipment</i> used to generate electricity and all the related <i>equipment</i> essential to its functioning as a single entity.
<i>generation</i>	The production of electric power by converting another form of <i>energy</i> into electricity in a <i>generating unit</i> .
<i>Generator</i>	Any person (including a <i>User</i> or the <i>Network Service Provider</i>) who owns, controls or operates a <i>generating system</i> that supplies electricity to, or who otherwise supplies electricity to, a <i>transmission system</i> or <i>distribution system</i> .
<i>generator machine</i>	the machine used for the generation of electricity, excluding related or auxiliary <i>equipment</i> .
<i>good electricity industry practice</i>	The meaning given in the <i>Access Code</i> .
<i>gradual bumpless transfer</i>	The make-before-break transfer of a <i>load</i> between <i>the distribution system</i> and an islanded <i>generating unit</i> (or vice versa) where the time for which the <i>generating unit</i> is operated in parallel with the <i>distribution system</i> is limited to less than 60 seconds.
<i>halving time</i>	The elapsed time required for the magnitude of a damped sine wave to reach half its initial value.
<i>high voltage</i>	Any nominal <i>voltage</i> above 1 kV.
<i>Independent Market Operator</i>	The entity authorised under the <i>Electricity Industry (Wholesale Electricity Market) Regulations 2004 (WA)</i> to administer and operate the Western Australia Wholesale Electricity Market.

ATTACHMENT 1 – GLOSSARY

<i>induction generating unit</i>	An alternating current <i>generating unit</i> whose rotor currents are produced by induction from its stator windings and, when driven above synchronous speed by an external source of mechanical power, converts mechanical power to electric power by means of a conventional induction machine.
<i>interconnection</i>	A <i>transmission line</i> or group of <i>transmission lines</i> that connects the <i>transmission systems</i> in adjacent <i>regions</i> .
<i>inverter coupled generating unit</i>	A <i>generating unit</i> which uses a machine, device, or system that <i>changes</i> its direct-current power to alternating-current power acceptable for <i>power system connection</i> .
<i>large disturbance</i>	A disturbance sufficiently large or severe as to prevent the linearization of system equations for the purposes of analysis. The resulting system response involves large excursions of system variables from their pre-disturbance values, and is influenced by non-linear power-angle relationship and other non-linearity effects in <i>power systems</i> . <i>Large disturbance</i> is typically caused by a short circuit on a nearby <i>power system</i> component (for example, <i>transmission line</i> , <i>transformer</i> , etc).
<i>load</i>	Either: (a) a <i>connection point</i> at which electric power is made available to a person; or (b) the amount of electric power transfer at a defined instant at a specified point on the <i>transmission or distribution system</i> as the case requires.
<i>load shedding</i>	Reducing or <i>disconnecting load</i> from the <i>power system</i> .
<i>low voltage</i>	Any nominal <i>voltage</i> of 1 kV and below
<i>main protection scheme</i>	A <i>protection scheme</i> that has the primary purpose of disconnecting specific <i>equipment</i> from the <i>transmission and distribution system</i> in the event of a fault occurring within that <i>equipment</i> .
<i>main protection system</i>	A <i>protection system</i> that has the primary purpose of disconnecting specific <i>equipment</i> from the <i>transmission and distribution system</i> in the event of a fault occurring within that <i>equipment</i> .
<i>maintenance conditions</i>	The operating conditions that exist when a significant element of the <i>transmission system</i> or the <i>distribution system</i> has been taken out of service in a planned manner so that maintenance can be carried out safely.

ATTACHMENT 1 – GLOSSARY

<i>maximum fault current</i>	The current that will flow to a fault on an item of <i>equipment</i> when <i>maximum system conditions</i> prevail.
<i>maximum system conditions</i>	For any particular location in the <i>power system</i> , those conditions that prevail when the maximum number of <i>generating units</i> that are normally <i>connected</i> at times of maximum <i>generation</i> are so <i>connected</i> .
<i>minimum fault current</i>	The current that will flow to a fault on an item of <i>equipment</i> when <i>minimum system conditions</i> prevail.
<i>minimum system conditions</i>	For any particular location in the <i>power system</i> , those conditions that prevail when: <ul style="list-style-type: none"> (a) the least number of <i>generating units</i> normally <i>connected</i> at times of minimum <i>generation</i> are so <i>connected</i>; and (b) there is one primary <i>equipment outage</i>. <p>The primary <i>equipment outage</i> is taken to be that which, in combination with the minimum <i>generation</i>, leads to the lowest fault current at the particular location for the fault type under consideration.</p>
<i>monitoring equipment</i>	The testing instruments and devices used to record the performance of <i>equipment</i> for comparison with expected performance.
<i>month</i>	The meaning given to it in section 62 of the <i>Interpretation Act 1984</i> (WA).
<i>nameplate rating</i>	The maximum continuous output or consumption specified either in units of <i>active power</i> (watts) or apparent power (volt-amperes) of an item of <i>equipment</i> as specified by the manufacturer.
<i>Network Service Provider</i>	The meaning given to it in clause 1.3(a).
<i>new capacity</i>	Any increase in electricity <i>generation, transmission</i> or <i>distribution</i> capacity which would arise from enhancement to or expansion of the electricity <i>generation, transmission system</i> or <i>distribution system</i> .
<i>nomenclature standards</i>	The standards approved by the <i>Network Service Provider</i> relating to numbering, terminology and abbreviations used for information transfer between <i>Users</i> as provided for in clause 5.11.
<i>non-dispatchable generating unit</i>	A <i>generating unit</i> that in its satisfactory normal operating state is not capable of closely controlling its real power output.

ATTACHMENT 1 – GLOSSARY

<i>normal operating state</i>	Characterises operation when all significant elements of a <i>transmission system</i> are in service and operation is within the secure <i>technical envelope</i> .
<i>operational communication</i>	A communication concerning the arrangements for, or actual operation of, the <i>power system</i> in accordance with the <i>Rules</i> .
<i>operator</i>	The person or organisation responsible for the provision of service in real time.
<i>outage</i>	Any planned or unplanned full or partial unavailability of <i>equipment</i> .
<i>peak load</i>	Maximum <i>load</i> .
<i>Perth CBD Zone</i>	The meaning given in the <i>Access Code</i> .
<i>power factor</i>	The ratio of the <i>active power</i> to the apparent power at a point.
<i>power station</i>	The one or more <i>generating units</i> at a particular location and the apparatus, <i>equipment</i> , buildings and necessary associated supporting resources for those <i>generating units</i> , including <i>black start-up equipment</i> , <i>step-up transformers</i> , <i>substations</i> and the <i>power station control centre</i> .
<i>power system</i>	The electric <i>power system</i> constituted by the <i>South West Interconnected Network</i> and its connected <i>generation</i> and <i>loads</i> , operated as an integrated system.
<i>power system operating procedures</i>	The procedures to be followed by <i>Users</i> in carrying out operations and maintenance activities on or in relation to <i>primary equipment</i> and <i>secondary equipment connected</i> to or forming part of the <i>power system</i> or <i>connection points</i> , as described in clause 5.9.1.
<i>power system security</i>	The safe scheduling, operation and control of the <i>power system</i> on a continuous basis in accordance with the principles set out in clause 5 and the operating procedures of the <i>Network Service Provider</i> or <i>System Management</i> .
<i>power system stability</i>	The ability of an electric <i>power system</i> , for a given initial operating condition, to regain a state of operating equilibrium after being subjected to a physical disturbance, with most system variables bounded so that practically the entire system remains intact.
<i>power transfer</i>	The instantaneous rate at which <i>active energy</i> is transferred between <i>connection points</i> .

ATTACHMENT 1 – GLOSSARY

<i>power transfer capability</i>	The maximum permitted <i>power transfer</i> through a <i>transmission or distribution system</i> or part thereof.
<i>primary equipment</i>	Refers to apparatus which conducts <i>power system load</i> or conveys <i>power system voltage</i> .
<i>protection</i>	The detection, limiting and removal of the effects of primary <i>equipment</i> faults from the <i>power system</i> ; or the apparatus, device or system required to achieve this function.
<i>protection apparatus</i>	Includes all relays, meters, power circuit breakers, synchronisers and other control devices necessary for the proper and safe operation of the <i>power system</i> .
<i>protection scheme</i>	An arrangement of <i>secondary equipment</i> designed to protect <i>primary equipment</i> from damage by detecting a fault condition and sending a signal to disconnect the <i>primary equipment</i> from the <i>transmission or distribution system</i> .
<i>protection system</i>	A system designed to disconnect faulted <i>primary equipment</i> from the <i>transmission or distribution system</i> , which includes one or more <i>protection schemes</i> and which also includes the <i>primary equipment</i> used to effect the disconnection.
<i>quality of supply</i>	With respect to electricity, technical attributes to a standard set out in clause 2.2, unless otherwise stated in these <i>Rules</i> or the relevant <i>connection agreement</i> .
<i>rapid bumpless transfer</i>	The make-before-break transfer of a <i>load</i> between <i>the distribution system</i> and an islanded <i>generating unit</i> (or vice versa) where the time for which the <i>generating unit</i> is operated in parallel with the <i>distribution system</i> is limited to less than 1 second.
<i>reactive energy</i>	A measure, in VAr hours (VArh) of the alternating exchange of stored <i>energy</i> in inductors and capacitors, which is the time-integral of the product of <i>voltage</i> and the out-of-phase component of current flow across a <i>connection point</i> .
<i>reactive equipment</i>	That equipment which is normally provided specifically to be capable of providing or absorbing <i>reactive power</i> , and includes the <i>equipment</i> identified in clause 5.4.1(f).

ATTACHMENT 1 – GLOSSARY

<p><i>reactive power</i></p>	<p>The rate at which <i>reactive energy</i> is transferred, measured in VAr.</p> <p><i>Reactive power</i> is a necessary component of alternating current electricity which is separate from <i>active power</i> and is predominantly consumed in the creation of magnetic fields in motors and <i>transformers</i> and produced by <i>equipment</i> such as:</p> <ul style="list-style-type: none"> (a) alternating current <i>generating units</i>; (b) capacitors, including the capacitive effect of parallel <i>transmission wires</i>; (c) <i>synchronous condensers</i>. <p><i>Reactive power</i> is obtained from a combination of static and dynamic sources. Static sources include, for example, <i>reactors</i> and <i>capacitor banks</i>, and the charging current of <i>transmission lines</i>. Dynamic sources include, for example, synchronous machines, operating as <i>generating units</i> or synchronous compensators, and <i>static VAr compensators</i>.</p>
<p><i>reactive power capability</i></p>	<p>The maximum rate at which <i>reactive energy</i> may be transferred from a <i>generating unit</i> to a <i>connection point</i> as specified in the relevant <i>connection agreement</i>.</p>
<p><i>reactive power reserve</i></p>	<p>Unutilised sources of <i>reactive power</i> arranged to be available to cater for the possibility of the unavailability of another source of <i>reactive power</i> or increased requirements for <i>reactive power</i>.</p>
<p><i>reactor</i></p>	<p>A device, similar to a <i>transformer</i>, arranged to be <i>connected</i> into the <i>transmission</i> or <i>distribution system</i> during periods of low <i>load</i> demand or low <i>reactive power</i> demand to counteract the natural capacitive effects of long <i>transmission lines</i> in generating excess <i>reactive power</i> and so correct any <i>transmission voltage</i> effects during these periods.</p>
<p><i>region</i></p>	<p>An area determined by the <i>Network Service Provider</i> to be a <i>region</i>, being an area served by a particular part of the <i>transmission system</i> containing one or more:</p> <ul style="list-style-type: none"> (a) concentrated areas of <i>load</i> or <i>loads</i> with a significant combined consumption capability; or (b) concentrated areas containing one or more <i>generating units</i> with significant combined generating capability, or both.
<p><i>reliability</i></p>	<p>A measure of the probability of <i>equipment</i> performing its function adequately for the period of time intended, under the operating conditions encountered.</p>

ATTACHMENT 1 – GLOSSARY

reliable	The expression of a recognised degree of confidence in the certainty of an event or action occurring when expected.
remote control equipment (RCE)	Equipment installed to enable the <i>Network Service Provider</i> to control a <i>generating unit</i> circuit breaker or other circuit breaker remotely.
remote monitoring equipment (RME)	Equipment installed to enable the monitoring of other <i>equipment</i> from a remote <i>control centre</i> , and includes a remote terminal unit (<i>RTU</i>).
representative	In relation to a person, any employee, agent or consultant of: (a) that person; or (b) a related body corporate of that person; or (c) a third party contractor to that person.
reserve	The <i>active power</i> and <i>reactive power</i> available to the <i>power system</i> at a nominated time but not currently utilised.
rotor angle stability	The ability of synchronous machines on an <i>interconnected power system</i> to remain in <i>synchronism</i> after being subjected to a disturbance, and which may comprise small-disturbance or transient stability, or both. Instability from a disturbance may occur in the form of increasing angular swings of some <i>generating units</i> , leading to loss of <i>synchronism</i> between <i>generating units</i> . Loss of <i>synchronism</i> can occur between one machine and the rest of the <i>power system</i> , or between groups of machines, with <i>synchronism</i> being maintained within each group after separating from each other.
RTU	A remote terminal unit installed within a <i>substation</i> to enable monitoring and control of <i>equipment</i> from a remote <i>control centre</i> .
Rules	These <i>Rules</i> , also called the "Technical <i>Rules</i> ", prepared by the <i>Network Service Provider</i> under Chapter 12 of the <i>Access Code</i> .
Rules commencement date	The date given in clause 1.4 of these <i>Rules</i> .
SCADA system	Supervisory control and data acquisition <i>equipment</i> which enables the <i>Network Service Provider</i> monitor continuously and remotely, and to a limited extent control, the import or export of electricity from or to the <i>power system</i> .
scheduled generating unit	A <i>generating unit</i> which is <i>dispatched</i> by the <i>Network Service Provider</i> .

ATTACHMENT 1 – GLOSSARY

<i>secondary equipment</i>	<i>Equipment within a facility or the electricity transmission or distribution systems which does not carry the energy being transferred, but which is required for control, protection or operation of other equipment that does carry such energy.</i>
<i>security</i>	The security of a <i>power system</i> is the degree of risk in its ability to survive imminent disturbances (contingencies) without interruption of service to <i>Users</i> . As it relates to the robustness of the system to imminent disturbances, it depends on the system operating condition as well as the contingent probability of disturbances.
<i>sensitivity</i>	In relation to <i>protection schemes</i> , has the meaning in clause 2.9.6.
<i>service provider</i>	The meaning given in the <i>Access Code</i> .
<i>shunt capacitor</i>	A type of <i>equipment connected to a transmission or distribution system to generate reactive power.</i>
<i>shunt reactor</i>	A type of <i>equipment connected to a transmission or distribution system to absorb reactive power.</i>
<i>single contingency</i>	In respect of a <i>transmission system</i> , a sequence of related events which result in the removal from service of one <i>transmission line</i> , <i>transformer</i> or other item of <i>equipment</i> . The sequence of events may include the application and clearance of a fault of defined severity.
<i>small disturbance</i>	A disturbance sufficiently small to permit the linearization of system equations for the purposes of analysis. The resulting system response involves small excursions of system variables from their pre-disturbance values. <i>Small disturbances</i> may be caused by routine switching (for example, line or capacitor), <i>transformer tap changes</i> , <i>generating unit AVR set point changes</i> , changes in the connected load, etc.
<i>small-disturbance rotor angle stability</i>	The ability of the power system to maintain <i>synchronism</i> under <i>small disturbances</i> .
<i>small use customer</i>	A <i>Consumer</i> that consumes less than 160 MWh of electricity per annum.
<i>small zone fault</i>	A fault which occurs on an area of <i>equipment</i> that is within the zone of detection of a <i>protection scheme</i> , but for which not all contributions to the fault will be cleared by the circuit breaker(s) tripped by that <i>protection scheme</i> . For example, a fault in the area of <i>equipment</i> between a <i>current transformer</i> and a circuit breaker, fed from the <i>current transformer</i> side, may be a <i>small zone fault</i> .

ATTACHMENT 1 – GLOSSARY

<i>South West Interconnected Network or SWIN</i>	The <i>transmission and distribution system</i> in South West of the state of Western Australia, extending from Geraldton to Albany areas and across to the Eastern Goldfields, as defined in the <i>Act</i> .
<i>spare capacity</i>	Any portion of firm capacity or non-firm capacity not committed to existing <i>Users</i> .
<i>static excitation system</i>	An <i>excitation control system</i> in which the power to the rotor of a <i>synchronous generating unit</i> is transmitted through high power solid-state electronic devices.
<i>static VAr compensator</i>	A device provided on a <i>transmission or distribution system</i> specifically to provide the ability to generate and absorb <i>reactive power</i> and to respond automatically and rapidly to <i>voltage</i> fluctuations or <i>voltage</i> instability arising from a disturbance or disruption on the <i>transmission or distribution system</i> .
<i>static synchronous compensator</i>	A device provided on a <i>transmission or distribution system</i> specifically to provide the ability to generate and absorb <i>reactive power</i> and to respond automatically and rapidly to <i>voltage</i> fluctuations or <i>voltage</i> instability arising from a disturbance or disruption on the <i>transmission or distribution system</i> .
<i>substation</i>	A <i>facility</i> at which lines are switched for operational purposes, and which may include one or more <i>transformers</i> so that some <i>connected</i> lines operate at different nominal <i>voltages</i> to others.
<i>supply</i>	The delivery of electricity as defined in the <i>Act</i> .
<i>supply transformer</i>	A <i>transformer</i> , forming part of the <i>transmission system</i> , which delivers electricity to the <i>distribution system</i> by converting it from the <i>voltage</i> of the <i>transmission system</i> to the <i>voltage</i> of the <i>distribution system</i> .
<i>synchronisation</i>	The act of synchronising a <i>generating unit</i> to the <i>power system</i> .
<i>synchronism</i>	A condition in which all machines of the synchronous type (<i>generating units</i> and motors) that are <i>connected</i> to a <i>transmission or distribution system</i> rotate at the same average speed, resulting in controlled sharing of the transfer of power. Loss of <i>synchronism</i> causes uncontrolled transfers of power between machine groups, causing severe and widespread disturbances of <i>supply</i> to <i>Users</i> , disconnection of <i>transmission lines</i> , possible damage to synchronous machines and system shutdown.

ATTACHMENT 1 – GLOSSARY

<i>synchronous condenser</i>	An item of equipment, similar in construction to a <i>generating unit</i> of the <i>synchronous generating unit</i> category, which operates at the equivalent speed of the <i>frequency</i> of the <i>power system</i> , provided specifically to generate or absorb <i>reactive power</i> through the adjustment of rotor current.
<i>synchronous generating unit voltage control</i>	The automatic <i>voltage control system</i> of a <i>generating unit</i> of the <i>synchronous generating unit</i> category which <i>changes</i> the output <i>voltage</i> of the <i>generating unit</i> through the adjustment of the <i>generating unit</i> rotor current and effectively <i>changes</i> the <i>reactive power</i> output from that <i>generating unit</i> .
<i>synchronous generating unit</i>	The alternating current <i>generating units</i> which operate at the equivalent speed of the <i>frequency</i> of the <i>power system</i> in its <i>normal operating state</i> .
<i>System Management</i>	The meaning given in the Wholesale Electricity Market Rules.
<i>tap-changing transformer</i>	A <i>transformer</i> with the capability to allow internal adjustment of output <i>voltages</i> which can be automatically or manually initiated while on-line and which is used as a major component in the control of the <i>voltage</i> of the <i>transmission and distribution systems</i> in conjunction with the operation of <i>reactive equipment</i> . The <i>connection point</i> of a <i>generating unit</i> may have an associated <i>tap-changing transformer</i> , usually provided by the Generator.
<i>technical envelope</i>	The limits described in the Wholesale Electricity Market Rules.
<i>technical minimum</i>	The minimum continuous active power output of a <i>generating unit</i> .
<i>terminal station</i>	A substation that transforms electricity between two <i>transmission system voltages</i> and which supplies electricity to <i>zone substations</i> but which does not supply electricity to the <i>distribution system</i> .
<i>thermal generating unit</i>	A <i>generating unit</i> which uses fuel combustion for electricity generation.
<i>total fault clearance time</i>	The time from fault inception to the time of complete fault interruption by a circuit breaker or circuit breakers. This is to be taken, as a minimum, to be equal to 10 milliseconds plus the circuit breaker maximum break time plus the maximum <i>protection</i> operating time.
<i>transformer</i>	A piece of <i>equipment</i> that reduces or increases the <i>voltage</i> of alternating current.

ATTACHMENT 1 – GLOSSARY

<i>transformer tap position</i>	Where a tap changer is fitted to a <i>transformer</i> , each tap position represents a <i>change</i> in <i>voltage</i> ratio of the <i>transformer</i> which can be manually or automatically adjusted to <i>change</i> the <i>transformer</i> output <i>voltage</i> . The tap position is used as a reference for the output <i>voltage</i> of the <i>transformer</i> .
<i>transient rotor angle stability</i>	The ability of the <i>power system</i> to maintain <i>synchronism</i> when subjected to severe disturbances, for example a short circuit on a nearby <i>transmission line</i> . The resulting system response involves large excursions of <i>generating unit</i> rotor angles and is influenced by the non-linear power-angle relationship.
<i>transmission</i>	The functions performed by a <i>transmission system</i> , including conveying, transferring or permitting the passage of electricity.
<i>transmission and distribution systems</i>	The <i>Network Service Provider's transmission system</i> and the <i>distribution system</i> collectively.
<i>transmission element</i>	A single identifiable major component of a <i>transmission system</i> involving: (a) an individual <i>transmission</i> circuit or a phase of that circuit; (b) a major item of <i>transmission equipment</i> necessary for the functioning of a particular <i>transmission</i> circuit or <i>connection point</i> (such as a <i>transformer</i> or a circuit breaker).
<i>transmission equipment</i>	The <i>equipment</i> associated with the function or operation of a <i>transmission line</i> or an associated <i>substation</i> , which may include <i>transformers</i> , circuit breakers, <i>reactive equipment</i> and <i>monitoring equipment</i> and control <i>equipment</i> .
<i>transmission line</i>	A power line that is part of a <i>transmission system</i> .
<i>transmission or distribution system</i>	Either the <i>transmission system</i> or the <i>distribution system</i> .
<i>transmission system</i>	Any apparatus, <i>equipment</i> , plant or buildings used, or to be used, for, or in connection with, the transportation of electricity at nominal voltages of 66 kV or higher, and which forms part of the <i>South West Interconnected Network</i> . For the avoidance of doubt the <i>transmission system</i> includes equipment such as static reactive power compensators, which is operated at voltages below 66 kV, provided that the primary purpose of this <i>equipment</i> is to support the transportation of <i>electricity</i> at voltages of 66 kV or higher.
<i>transmission system planning criteria</i>	The criteria prepared by the <i>Network Service Provider</i> under section A6.1(m) of the <i>Access Code</i> .

ATTACHMENT 1 – GLOSSARY

<i>trip circuit supervision</i>	A function incorporated within a <i>protection scheme</i> that results in alarming for the loss of integrity of the <i>protection scheme's</i> trip circuit. <i>Trip circuit supervision</i> supervises a <i>protection scheme's</i> trip <i>supply</i> together with the integrity of associated wiring, cabling and circuit breaker trip coil.
<i>trip supply supervision</i>	A function incorporated within a <i>protection scheme</i> that results in alarming for loss of trip <i>supply</i> .
<i>turbine control system</i>	The automatic <i>control system</i> which regulates the speed and power output of a <i>generating unit</i> through the control of the rate of entry into the <i>generating unit</i> of the primary <i>energy</i> input (for example, steam, gas or water).
<i>two fully independent protection schemes of differing principle</i>	<p><i>Protection schemes</i> having <i>differing principles</i> of operation and which, in combination, provide dependable detection of faults on the protected <i>primary equipment</i> and operate within a specified time, despite any single failure to operate of the <i>secondary equipment</i>.</p> <p>To achieve this, complete secondary <i>equipment</i> redundancy is required, including <i>current transformer</i> and <i>voltage transformer</i> secondaries, auxiliary supplies, signalling systems, cabling, wiring, and circuit breaker trip coils. Auxiliary supplies include DC supplies for <i>protection</i> purposes. Therefore, to satisfy the redundancy requirements, each <i>protection scheme</i> would need to have its own independent battery and battery charger system supplying all that <i>protection scheme's</i> trip functions.</p> <p>In addition the relays of each <i>protection scheme</i> must be grouped in separate physical locations (which need not be in different panels). Furthermore the two <i>protection schemes</i> must either use different methods of operation or, alternatively, have been designed and manufactured by different organisations.</p>
<i>User</i>	Has the meaning given in clause 1.3(b)(3).
<i>voltage</i>	The electronic force or electric potential between two points that gives rise to the flow of electricity.
<i>voltage stability</i>	<p>The ability of a <i>power system</i> to attain steady <i>voltages</i> at all <i>busbars</i> after being subjected to a disturbance from a given operating condition.</p> <p>Instability that may result occurs in the form of a progressive fall or rise of <i>voltages</i> at some <i>busbars</i>. Possible outcomes of <i>voltage</i> instability are loss of <i>load</i> in an area, or the tripping of <i>transmission lines</i> and other elements, including <i>generating units</i>, by their protective systems leading to <i>cascading outages</i>.</p>

ATTACHMENT 1 – GLOSSARY

<i>voltage transformer (VT)</i>	A <i>transformer</i> for use with meters and/or <i>protection</i> devices in which the <i>voltage</i> across the secondary terminals is, within prescribed error limits, proportional to and in phase with the <i>voltage</i> across the primary terminals.
<i>WA Electrical Requirements</i>	The WA Electrical Requirements issued under Regulation 49 of the <i>Electricity (Licensing) Regulations 1991</i> (WA) and available from Internet site http://www.energysafety.wa.gov.au/
<i>wind farm</i>	A <i>power station</i> consisting of one or more wind powered <i>generating units</i> .
<i>written law</i>	The meaning given to it in section 5 of the <i>Interpretation Act 1984</i> (WA).
<i>zone substation</i>	A <i>substation</i> that transforms electricity from a <i>transmission system voltage</i> to a <i>distribution system voltage</i> .

ATTACHMENT 2- INTERPRETATION

In these *Rules*, headings and captions are for convenience only and do not affect interpretation and, unless the contrary intention appears from the context, and subject to the *Act* and the *Access Code*, these *Rules* must be interpreted in accordance with the following rules of interpretation:

- (a) a reference in these *Rules* to a contract or another instrument includes a reference to any amendment, variation or replacement of it save for a reference to an *Australian Standard* that explicitly states a date or year of publication;
- (b) a reference to a person includes a reference to the person's executors, administrators, successors, substitutes (including persons taking by novation) and assigns;
- (c) references to time are to Western Standard Time, being the time at the 120th meridian of longitude east of Greenwich in England, or Coordinated Universal Time, as required by the *National Measurement Act 1960* (Cth);
- (d) any calculation must be performed to the accuracy, in terms of a number of decimal places, determined by the *Network Service Provider* in respect of all *Users*;
- (e) where any word or phrase is given a defined meaning, any part of speech or other grammatical form of that word or phrase has a corresponding meaning;
- (f) the word "including" means "including, but without limiting the generality of the foregoing" and other forms of the verb "to include" are to be construed accordingly;
- (g) a *connection point* is a *User's connection point* or a *connection point* of a *User* if it is the subject of a *connection agreement* between the *User* and the *Network Service Provider*;
- (h) a reference to a half hour is a reference to a 30 minute period ending on the hour or on the half hour and, when identified by a time, means the 30 minute period ending at that time; and
- (i) measurements of physical quantities are in Australian legal units of measurement within the meaning of the *National Measurement Act 1960* (Cth).

**ATTACHMENT 3 - SUMMARY OF SCHEDULES OF TECHNICAL
DETAILS TO SUPPORT APPLICATION FOR CONNECTION**

- A3.1. Various sections of the Code require that *Users* submit technical data to the *Network Service Provider*. This Attachment 3 summarises schedules which list the typical range of data which may be required and explains the terminology. Data additional to those listed in the schedules may be required. The actual data required will be advised by the *Network Service Provider* at the time of assessment of a *transmission* or *distribution access application*, and will form part of the technical specification in the *access contract* or *connection agreement*.
- A3.2. Data is coded in categories, according to the stage at which it is available in the build-up of data during the process of forming a connection or obtaining access to a *transmission system*, with data acquired at each stage being carried forward, or enhanced in subsequent stages, e.g. testing.

Preliminary system planning data

This is data required for submission with the *access application* or connection application, to allow the *Network Service Provider* to prepare an offer of terms for a *connection agreement* and to assess the requirement for, and effect of, *transmission and distribution system augmentation* or *extension* options. Such data is normally limited to the items denoted as Standard Planning Data (S) in the technical data schedules in Attachment 4 to Attachment 10.

the *Network Service Provider* may, in cases where there is doubt as to the viability of a proposal, require the submission of other data before making an access offer to connect or to amend an *access contract* or *connection agreement*.

Registered system planning data

This is the class of data which will be included in the *access contract* or *connection agreement* signed by both parties. It consists of the preliminary system planning data plus those items denoted in the attached schedules as Detailed Planning Data (D). The latter must be submitted by the *User* in time for inclusion in the *access contract* or *connection agreement*.

Registered data

Registered Data consists of data validated and augmented prior to actual connection a provision of access from manufacturers' data, detailed design calculations, works or site tests etc.(R1); and data derived from on-system testing after connection (R2).

All of the data will, from this stage, be categorised and referred to as Registered Data; but for convenience the schedules omit placing a higher ranked code next to items which are expected to already be valid at an earlier stage.

- A3.3. Data will be subject to review at reasonable intervals to ensure its continued accuracy and relevance. The *Network Service Provider* must initiate this review. A *User* may *change* any data item at a time other than when that item would normally be reviewed or updated by

ATTACHMENT 3 – SCHEDULES OF TECHNICAL DETAILS

submission to the *Network Service Provider* of the revised data, together with authentication documents, egotist reports.

A3.4. Attachment 4 to Attachment 12, cover the following data areas:

- (a) Attachment 4 – Large *Generating Unit* Design Data. This comprises large *generating unit* fixed design parameters.
- (b) Attachment 5: - *Protection Systems* Design and Setting Data. This comprises design and setting data for *protection systems* that must coordinate or interface with the *protection systems* for the *transmission and distribution system* or that could impact the operation of the *transmission and distribution system*.
- (c) Attachment 6 – Large *Generating unit* Setting Data. This comprises settings which can be varied by agreement or by *direction* of the *Network Service Provider*.
- (d) Attachment 7 - *Transmission system* and *equipment* Technical Data. This comprises fixed electrical parameters.
- (e) Attachment 8 - *Transmission equipment* and Apparatus Setting Data. This comprises settings which can be varied by agreement or by *direction* of the *Network Service Provider*.
- (f) Attachment 9 - *Load* Characteristics. This comprises the estimated parameters of *load* groups in respect of, for example, harmonic content and response to *frequency* and *voltage* variations.
- (g) Attachment 10 - *Design Data For Small Power Stations Connected To The Distribution System*. This comprises a reduced set of design parameters that the *Network Services Provider* may require for small *power stations* covered by clause 3.6 of the *Rules*.
- (h) Attachment 11 – Test Schedule for Specific Performance Verification and Model Evaluation of Large *Generating Units*. This comprises a schedule of commissioning and performance tests that the *Network Service Provider* may require for large *generating units* covered by clause 3.3 of the *Rules*.
- (i) Attachment 12 – Testing and Commissioning of Small *Power Stations* Connected to the *Distribution System*. This comprises a schedule of commissioning and performance tests that the *Network Service Provider* may require for small *power stations* covered by clause 3.3 of the *Rules*.

A3.5. A *Generator* that connects a large *generating unit* that is not a *synchronous generating unit* must be given exemption from complying with those parts of schedules in Attachment 4 and 6 that are determined by the *Network Service Provider* to be not relevant to such *generating units*, but must provide the information required by with those parts of the schedules in Attachments 5, 7, 8 and 9 that are relevant to such *generating units*, as determined by the

ATTACHMENT 3 – SCHEDULES OF TECHNICAL DETAILS

Network Service Provider. For this *non-synchronous generating unit*, additional data may be requested by the *Network Service Provider*.

Codes:

S = Standard Planning Data

D = Detailed Planning Data

R = Registered Data (R1 *pre-connection*, R2 *post-connection*)

ATTACHMENT 4 - LARGE *GENERATING UNIT* DESIGN DATA

Symbol	Data Description	Units	Data Category
<i>Power station technical data:</i>			
	<i>Connection point to Transmission system</i>	Text, diagram	S, D
	Nominal <i>voltage at connection point to Transmission system</i>	kV	S
	Total Station Net Maximum Capacity (NMC)	MW (sent out)	S, D, R2
<i>At connection point:</i>			
	· Maximum 3 phase short circuit infeed calculated by method of AS 3851 (1991) (Amendment 1-1992)		
	· Symmetrical	kA	S, D
	· Asymmetrical	kA	D
	· Minimum zero sequence impedance	(a+jb) ohms	D
	· Minimum negative sequence impedance	(a+jb) ohms	D
<i>Individual synchronous generating unit data:</i>			
	· Make		
	· Model		
MBASE	· Rated MVA	MVA	S, D, R1
PSO	· Rated MW (Sent Out)	MW (sent out)	S, D, R1
PMAX	· Rated MW (<i>generated</i>)	MW (Gen)	D
VT	· Nominal Terminal <i>Voltage</i>	kV	D, R1
PAUX	· Auxiliary <i>load</i> at PMAX	MW	S, D, R2
Qmax	· Rated Reactive Output at PMAX	MVA _r (sent out)	S, D, R1
PMIN	· Minimum <i>Load</i> (ML)	MW (sent out)	S, D, R2

ATTACHMENT 4 – LARGE *GENERATING UNIT* DESIGN DATA

H	·	Inertia Constant for all rotating masses <i>connected to the generating unit shaft</i> (for example, <i>generating unit</i> , turbine, etc)	MWs/rated MVA	S, D, R1
Hg	·	<i>Generating unit</i> Inertia Constant (applicable to <i>synchronous condenser</i> mode of operation)	MWs/rated MVA	S, D, R1
GSCR	·	Short Circuit Ratio		D, R1
ISTATOR	·	Rated Stator Current	A	D, R1
IROTOR	·	Rated Rotor Current at rated MVA and <i>Power factor</i> , rated terminal volts and rated speed	A	D,R1
VROTOR	·	Rotor <i>Voltage</i> at which IROTOR is achieved	V	D, R1
VCEIL	·	Rotor <i>Voltage</i> capable of being supplied for five seconds at rated speed during field forcing	V	D, R1
ZN	·	Neutral Earthing Impedance	(a+jb)%*	

Generating unit resistance:

RA	·	Stator Resistance	% on MBASE	S, D, R1, R2
RF	·	Rotor resistance at 20°C	ohms	D, R1

* MVA base must be clearly stated.

Symbol	Data Description	Units	Data Category
<i>Generating unit sequence impedances (saturated):</i>			
Z0	Zero Sequence Impedance	(a+jb)% on MBASE	D,R1
Z2	Negative Sequence Impedance	(a+jb)% on MBASE	D,R1
<i>Generating unit reactances (saturated):</i>			
XD'(sat)	Direct Axis Transient Reactance	% on MBASE	D,R1
XD"(sat)	Direct Axis Sub-Transient Reactance	% on MBASE	D,R1
<i>Generating unit reactances (unsaturated):</i>			
XD	Direct Axis Synchronous Reactance	% on MBASE	S, D, R1, R2
XD'	Direct Axis Transient Reactance	% on MBASE	S, D, R1, R2
XD''	Direct Axis Sub-Transient Reactance	% on MBASE	S, D, R1, R2
XQ	Quadrature Axis Synch Reactance	% on MBASE	D, R1, R2
XQ'	Quadrature Axis Transient Reactance	% on MBASE	D, R1, R2
XQ''	Quadrature Axis Sub-Transient Reactance	% on MBASE	D,R1, R2
XL	Stator Leakage Reactance	% on MBASE	D, R1, R2
XO	Zero Sequence Reactance	% on MBASE	D, R1
X2	Negative Sequence Reactance	% on MBASE	D, R1
XP	Potier Reactance	% on MBASE	D, R1
<i>Generating unit time constants (unsaturated):</i>			
TDO'	Direct Axis Open Circuit Transient	Seconds	S, D, R1, R2
TDO''	Direct Axis Open Circuit Sub-Transient	Seconds	S, D, R1, R2

ATTACHMENT 4 – LARGE *GENERATING UNIT* DESIGN DATA

TKD	Direct Axis Damper Leakage	Seconds	D, R1, R2
TQO'	Quadrature Axis Open Circuit Transient	Seconds	D, R1, R2
TA	Armature Time Constant	Seconds	D, R1, R2
TQO''	Quadrature Axis Open Circuit Sub-Transient	Seconds	D, R1, R2

Charts:

GCD	Capability Chart	Graphical data	D, R1, R2
GOCC	Open Circuit Characteristic	Graphical data	R1
GSCC	Short Circuit Characteristic	Graphical data	R1
GZPC	<i>Zero power factor curve</i>	Graphical data	R1
	V curves	Graphical data	R1
GOTC	MW, MVA _r outputs versus temperature chart	Graphical data	D, R1, R2

Generating unit transformer:

GTW	Number of windings	Text	S, D
GTR _n	Rated MVA of each winding	MVA	S, D, R1
GTTR _n	Principal tap rated <i>voltages</i>	kV/kV	S, D, R1
GTZ1 _n	Positive Sequence Impedances (each wdg)	(a + jb) % on 100 MVA base	S, D, R1
GTZ2 _n	Negative Sequence Impedances (each wdg)	(a + jb) % on 100 MVA base	S, D, R1

Symbol	Data Description	Units	Data Category
GTZOn	Zero Sequence Impedances (each wdg)	(a + jb) % on 100 MVA base	S, D, R1
	Tapped Winding	Text, diagram	S, D, R1
GTAPR	Tap <i>Change</i> Range	kV - kV	S, D
GTAPS	Tap <i>Change</i> Step Size	%	D
	Tap <i>Changer</i> Type, On/Off <i>load</i>	On/Off	D
	Tap <i>Change</i> Cycle Time	Seconds	D
GTVG	Vector Group	Diagram	S, D
	Earthing Arrangement	Text, diagram	S, D
	Saturation curve	Diagram	R1
<i>Generating unit reactive capability (at machine terminals):</i>			
	Lagging <i>Reactive power</i> at P _{MAX}	MVA _r export	S, D, R2
	Lagging <i>Reactive power</i> at ML	MVA _r export	S, D, R2
	Lagging <i>Reactive Short Time</i> capability at rated MW, terminal <i>voltage</i> and speed	MVA _r (for time)	D, R1, R2
	Leading <i>Reactive power</i> at rated MW	MVA _r import	S,D, R2
<i>Generating unit excitation system:</i>			
	Make		
	Model		
	General description of <i>excitation control system</i> (including block diagram transfer function & parameters)	Text, diagram	S, D

ATTACHMENT 4 – LARGE *GENERATING UNIT* DESIGN DATA

Rated Field <i>Voltage</i> at rated MVA and <i>Power factor</i> and rated terminal volts and speed	V	S, D, R1
Maximum Field <i>Voltage</i>	V	S, D, R1
Minimum Field <i>Voltage</i>	V	D, R1
Maximum rate of <i>change</i> of Field <i>Voltage</i>	Rising V/s	D, R1
Maximum rate of <i>change</i> of Field <i>Voltage</i>	Falling V/s	D, R1
<i>Generating unit</i> and exciter Saturation Characteristics 50 - 120% V	Diagram	D, R1
Dynamic Characteristics of Over Excitation Limiter (drawn on capability <i>generating unit</i> diagram)	Text/ Block diagram	D, R2
Dynamic Characteristics of Under Excitation Limiter (drawn on capability <i>generating unit</i> diagram)	Text/ Block diagram	D, R2
 <i>Generating unit turbine / load controller (governor):</i>		
Make		
Model		
General description of <i>turbine control system</i> (including block diagram transfer function & parameters)	Text, diagram	S, D
Maximum Droop	%	S, D, R1

Symbol	Data Description	Units	Data Category
	Normal Droop	%	D, R1
	Minimum Droop	%	D, R1
	Maximum <i>Frequency</i> Dead band	Hz	D, R1
	Normal <i>Frequency</i> Dead band	Hz	D, R1
	Minimum <i>Frequency</i> Dead band	Hz	D, R1
	MW Dead band	MW	D, R1
<i>Generating unit response capability:</i>			
	Sustained response to <i>frequency change</i>	MW/Hz	D, R2
	Non-sustained response to <i>frequency change</i>	MW/Hz	D, R2
	<i>Load</i> Rejection Capability	MW	S, D, R2
Mechanical shaft model:			
(Multiple-stage steam turbine <i>generating units</i> only)			
	Dynamic model of turbine/ <i>generating unit</i> shaft system in lumped element form showing component inertias, damping and shaft stiffness.	Diagram	D
	Natural damping of shaft torsional oscillation modes.(for each mode)		
-	Modal <i>frequency</i>	Hz	D
-	Logarithmic decrement	Nepers/Sec	D
Steam Turbine Data:			
(Multiple-Stage Steam Turbines only)			
Fraction of power produced by each stage:			

ATTACHMENT 4 – LARGE *GENERATING UNIT* DESIGN DATA

Symbols	KHP		Per unit of Pmax	D
		KIP KLP1 KLP2		

Stage and reheat time constants:

Symbols	THP		Seconds	D
		TRH TIP TLP1 TLP2		

	Turbine <i>frequency</i> tolerance curve		Diagram	S, D, R1
--	--	--	---------	----------

Gas turbine data:

HRSG	Waste heat recovery boiler time constant (where applicable eg for <i>cogeneration equipment</i>)		Seconds	D
	MW output versus turbine speed (47-52 Hz)		Diagram	D, R1, R2
	Type of turbine (heavy industrial, aero derivative etc)		Text	S
	Number of shafts			S,D
	Gearbox Ratio			D

Symbol	Data Description	Units	Data Category
	Fuel type (gas, liquid)	Text	S,D
	Base <i>load</i> MW vs temperature	Diagram	D
	<i>Peak load</i> MW vs temperature	Diagram	D
	Rated exhaust temperature	°C	S,D
	Controlled exhaust temperature	°C	S,D,R1
	Turbine <i>frequency</i> tolerance capability	Diagram	D
	Turbine compressor surge map	Diagram	D

Hydraulic turbine data

Required data will be advised by the *Network Service Provider*

Wind farm/wind turbine data¹⁾

A typical 24 hour power curve measured at 15-minute intervals or better if available;		S, D, R1
maximum kVA output over a 60 second interval		S, D,R1
Long-term flicker factor for <i>generating unit</i>		S, D, R1
Long term flicker factor for wind farm		S,D,R1
Maximum output over a 60 second interval	kVA	S,D,R1
Harmonics current spectra	A	S,D,R1
Power curve MW vs. wind speed	Diagram	D
Spatial Arrangement of wind farm	Diagram	D
Startup profile MW, MVA _r vs time for individual Wind Turbine Unit and <i>Wind farm</i> Total	Diagram	D
Low Wind Shutdown profile MW, MVA _r vs time for individual Wind Turbine Unit and <i>Wind farm</i> Total	Diagram	D

ATTACHMENT 4 – LARGE *GENERATING UNIT* DESIGN DATA

MW, MVA_r vs time profiles for individual Wind Turbine Unit under normal ramp up and ramp down conditions. Diagram D

High Wind Shutdown profile MW, MVA_r vs time for individual Wind Turbine Unit and *Wind farm* Total Diagram D

Induction generating unit data

Make

Model

Type (squirrel cage, wound rotor, doubly fed)

MBASE	Rated MVA	MVA	S,D,R1
PSO	Rated MW (Sent out)	MW	S,D,R1
PMAX	Rated MW (<i>generated</i>)	MW	D
VT	Nominal Terminal <i>Voltage</i>	kV	S,D,R1
	Synchronous Speed	rpm	S,D,R1
	Rated Speed	rpm	S,D,R1
	Maximum Speed	rpm	S,D,R1
	Rated <i>Frequency</i>	Hz	S,D,R1
Qmax	Reactive consumption at PMAX	MVA _r import	S,D,R1
	Curves showing torque, <i>power factor</i> , efficiency, stator current, MW output versus slip (+ and -).	Graphical data	D,R1,R2
	Number of <i>capacitor banks</i> and MVA _r size at rated <i>voltage</i> for each <i>capacitor bank</i> (if used).	Text	S
	Control philosophy used for VAr <i>/voltage</i> control.	Text	S
H	Combined inertia constant for all rotating masses <i>connected</i> to the <i>generating unit</i> shaft (for example, <i>generating unit</i> , turbine, gearbox, etc) calculated at the synchronous speed	MW-sec/MVA	S,D,R1

Resistance

ATTACHMENT 4 – LARGE *GENERATING UNIT* DESIGN DATA

Rs	Stator resistance	% on MBASE	D,R1
Rs	Stator resistance versus slip curve, or two extreme values for zero (nominal) and unity (negative) slip	Graphical data or % on MBASE	D,R1

Reactances (saturated)

X'	Transient reactance	% on MBASE	D,R1
X''	Subtransient reactance	% on MBASE	D,R1

Reactances (unsaturated)

X	Sum of magnetising and primary winding leakage reactance.	% on MBASE	D,R1
X'	Transient reactance	% on MBASE	D,R1
X''	Subtransient reactance	% on MBASE	D,R1
Xl	Primary winding leakage reactance	% on MBASE	D,R1

Time constants (unsaturated)

T'	Transient	sec	S,D,R1,R2
T''	Subtransient	sec	S,D,R1,R2
Ta	Armature	sec	S,D,R1,R2
To'	Open circuit transient	sec	S,D,R1,R2
To''	Open circuit subtransient	sec	S,D,R1,R2

Converter data

Control: *transmission system* commutated or self commutated

Additional data may be required by the *Network Service Provider*

Doubly fed induction *generating unit* data

Required data will be advised by the *Network Service Provider*

ATTACHMENT 5 – SUBMISSION REQUIREMENTS FOR ELECTRICAL PLANT PROTECTION

ATTACHMENT 5 - SUBMISSION REQUIREMENTS FOR ELECTRICAL PLANT PROTECTION

TRANSMISSION ACCESS CODE DOCUMENT SUBMITTAL REQUIREMENTS FOR ELECTRICAL PLANT PROTECTION		
DATA SUBMISSION CODES (ALL REGISTERED DATA, ie AFTER SIGNING OF THE ACCESS AGREEMENT):		
D	As defined in Attachment 3: to be agreed in the access agreement.	
R1	As defined in Attachment 3: to be agreed in the access agreement.	
R2	As defined in Attachment 3: to be agreed in the access agreement.	
Item	Description	Submission Code
PROTECTION DESIGN PHILOSOPHY DOCUMENT:		
1	Documentation explaining the general protection philosophy. To include: <ul style="list-style-type: none"> - Present and design minimum and maximum fault levels. - Present and design minimum and maximum fault contributions to the network from the user, at the point of connection. - Details of required critical fault clearance times, and which protections will be employed to meet these times. - Local Backup (circuit breaker fail) philosophy - Special scheme philosophy (ie islanding or load shedding schemes) - Protection number 1 philosophy - Protection number 2 philosophy 	D, R1 and R2
2	Power single line diagram, down to and including the low voltage (greater than 50V AC) bus(s). To include: <ul style="list-style-type: none"> - Voltage levels, and - Transformer ratings, winding configurations and earthing connections - Generator ratings and earthing connections - Operating status of switching devices - Earthing configuration - Primary plant interlocks 	D, R1 & R2
3	Details of protection interfaces between the Transmission Network and the User.	D, R1 & R2
4	Protection single line diagram, down to and including the low voltage (greater than 50V AC) bus(s). To include: <ul style="list-style-type: none"> - Current transformer locations, rated primary and secondary current, rated short-time thermal current, rated output, accuracy class and designation. - Voltage Transformer locations, winding connections, rated primary and secondary voltages, rated output and accuracy class. - Relay make and model number - Relay functions employed - Primary plant mechanical protections - Trip details (diagramatic or by trip matrix) 	R1 & R2
5	Impedance diagram of the system, showing for each item of primary plant details of the positive, negative and zero sequence series and shunt impedances, including mutual coupling between physically adjacent elements. Impedances to be in per unit, referred to a 100MVA base. Final submission (C) to include tested values of generator and transformer impedances (ie from manufacturers test certificates)	R1 & R2
6	Tripping and control power supply (eg DC system) single line diagram.	R1 & R2
7	Power flow details at point of connection as per the data requested in Schedule S5.	R1 & R2
8	HV circuit breaker details: <ul style="list-style-type: none"> - A control and protection schematic diagram of the circuit breaker(s) at the user connection to the transmission network. - Type, rated current and rated fault MVA or rated breaking current of all HV circuit breakers 	R1 & R2
9	HV switch fuse details: <ul style="list-style-type: none"> - Rated current of fuse - Rated breaking current of fuse - Type of fuse - Current-time characteristic curves 	R1 & R2
PROTECTION SETTINGS PHILOSOPHY DOCUMENT:		
10	General settings philosophy	R1 & R2
11	Calculated critical fault clearance times	R1 & R2
12	Protection function settings to be employed and reasons for selecting these settings. Diagrams are to be submitted where applicable.	R1 & R2
13	Overcurrent grading curves for phase faults.	R1 & R2
14	Overcurrent grading curves for earth faults.	R1 & R2

ATTACHMENT 6 - LARGE *GENERATING UNIT* SETTING DATA

Description Category	Units	Data
Protection Data:		
Settings of the following <i>protections</i>:		
Loss of field	Text	D
Under excitation	Text, diagram	D
Over excitation	Text, diagram	D
Differential	Text	D
Under <i>frequency</i>	Text	D
Over <i>frequency</i>	Text	D
Negative sequence component	Text	D
Stator <i>overvoltage</i>	Text	D
Stator overcurrent	Text	D
Rotor overcurrent	Text	D
Reverse power	Text	D

Control Data:

Details of *excitation control system* incorporating, where applicable, individual elements for *power system* stabiliser, under excitation limiter and over excitation limiter described in block diagram form showing transfer functions of individual elements, parameters and measurement units (preferably in IEEE format, but suitable for use in the software package nominated by the *Network Service Provider*. Currently, that package is PSS/E): The source code of the model must also be provided, in accordance with clause 3.3.8.

Text, diagram D,R1,R2

Settings of the following controls:

Details of the *turbine control system* described in block diagram form showing transfer functions of individual elements and measurement units (preferably in IEEE format, but suitable for use in the software package nominated by the *Network Service Provider*. Currently, that package is PSS/E). The source code of the model must also be provided, in accordance with clause 3.3.8.

ATTACHMENT 6 – LARGE *GENERATING UNIT* SETTING DATA

	Text, diagram	D,R1,R2
Stator current limiter (if fitted)	Text, diagram	D
Manual restrictive limiter (if fitted)	Text	D
<i>Load</i> drop compensation/VAr sharing (if fitted)	Text, function	D
V/f limiter (if fitted)	Text, diagram	D

ATTACHMENT 7 - TRANSMISSION SYSTEM AND EQUIPMENT TECHNICAL DATA OF EQUIPMENT AT OR NEAR CONNECTION POINT

Description	Units	Data Category
Voltage Rating		
Nominal <i>voltage</i>	kV	S, D
Highest <i>voltage</i>	kV	D
Insulation Co-ordination		
Rated lightning impulse withstand <i>voltage</i>	kVp	D
Rated short duration power <i>frequency</i> withstand <i>voltage</i>	kV	D
Rated Currents		
Circuit maximum current	kA	S, D
Rated Short Time Withstand Current	kA for seconds	D
Ambient conditions under which above current applies	Text	S,D
Earthing		
System Earthing Method	Text	S, D
Earth grid rated current	kA for seconds	D
Insulation Pollution Performance		
Minimum total creepage	mm	D
Pollution level	Level of IEC 815	D
Controls		
Remote control and data transmission arrangements	Text	D
Transmission system Configuration		
Operation Diagrams showing the electrical circuits of the existing and proposed main <i>facilities</i> within the <i>User's</i> ownership including <i>busbar</i> arrangements, phasing		Single line Diagrams S, D, R1

ATTACHMENT 7 – TRANSMISSION SYSTEM AND EQUIPMENT TECHNICAL DATA OF EQUIPMENT AT OR NEAR CONNECTION POINT

arrangements, earthing arrangements, switching *facilities* and operating *voltages*.

Transmission system Impedances

For each item of <i>equipment</i> (including lines): details of the positive, negative and zero sequence series and shunt impedances, including mutual coupling between physically adjacent elements.	% on 100 MVA base	S, D, R1
---	-------------------	----------

Short Circuit Infeed to the Transmission system

Maximum <i>Generating unit</i> 3-phase short circuit infeed including infeeds from <i>generating units</i> <i>connected</i> to the <i>User's</i> system, calculated by method of AS 3851 (1991)(Amndt 1-1992).	kA symmetrical	S, D, R1
---	----------------	----------

The total infeed at the instant of fault (including contribution of induction motors).	kA	D, R1
---	----	-------

Description	Units	Data Category
--------------------	--------------	----------------------

Minimum zero sequence impedance of <i>User's transmission system at connection point.</i>	% on 100 MVA base	D, R1
--	-------------------	-------

Minimum negative sequence impedance of <i>User's transmission system at connection point.</i>	% on 100 MVA base	D, R1
--	-------------------	-------

Load Transfer Capability:

Where a *load*, or group of *loads*, may be fed from
alternative *connection points*:

<i>Load</i> normally taken from <i>connection point X</i>	MW	D, R1
---	----	-------

<i>Load</i> normally taken from <i>connection point Y</i>	MW	D, R1
---	----	-------

Arrangements for transfer under planned or fault <i>outage</i> conditions	Text	D
--	------	---

Circuits Connecting *Embedded generating units* to the *Transmission system*:

For all *generating units*, all connecting lines/cables, *transformers* etc.

Series Resistance (+ve, -ve & zero seq.)	% on 100 MVA base	D, R
Series Reactance (+ve, -ve & zero seq.)	% on 100 MVA base	D, R
Shunt Susceptance (+ve, -ve & zero seq.)	% on 100 MVA base	D, R
Normal and short-time emergency ratings	MVA	D,R

Technical Details of *generating units* as per schedules S1, S2

***Transformers at connection points*:**

Saturation curve	Diagram	R
------------------	---------	---

ATTACHMENT 8 - *TRANSMISSION SYSTEM EQUIPMENT* AND APPARATUS SETTING DATA

Description	Units	Data Category
Protection Data for Protection relevant to		
Connection point:		
Reach of all <i>protections</i> on <i>transmission</i> lines, or cables	ohms or % on 100 MVA base	S, D
Number of <i>protections</i> on each item	Text	S, D
Total fault clearing times for near and remote faults	ms	S, D, R1
Line reclosure sequence details	Text	S, D, R1
Tap Change Control Data:		
Time delay settings of all <i>transformer</i> tap <i>changers</i> .	Seconds	D, R1
Reactive Compensation (including filter banks):		
Location and Rating of individual shunt <i>reactors</i>	MVA _r	D, R1
Location and Rating of individual shunt <i>capacitor banks</i>	MVA _r	D, R1
<i>Capacitor bank</i> capacitance	microfarads	D
Inductance of switching <i>reactor</i> (if fitted)	millihenries	D
Resistance of capacitor plus <i>reactor</i>	Ohms	D
Details of special controls (e.g. Point-on-wave switching)	Text	D
For each shunt reactor or capacitor bank (including filter banks):		
Method of switching	Text	S
Details of automatic control logic such that operating characteristics can be determined	Text	D, R1
FACTS Installation:		

ATTACHMENT 8 *TRANSMISSION SYSTEM EQUIPMENT* AND APPARATUS SETTING DATA

Data sufficient to enable static and dynamic performance of the installation to be modelled	Text, diagrams control settings	S, D, R1
Under <i>frequency load shedding</i> scheme:		
Relay settings (<i>frequency</i> and time)	Hz, seconds	S, D
Islanding scheme:		
Triggering signal (e.g. <i>voltage, frequency</i>)	Text	S, D
Relay settings	Control settings	S, D

ATTACHMENT 9 - *LOAD CHARACTERISTICS AT CONNECTION POINT*

Data Description	Units	Data Category
For all Types of Load		
Type of <i>Load</i> eg controlled rectifiers or large motor drives	Text	S
Rated capacity	MW, MVA	S
<i>Voltage</i> level	kV	S
Rated current	A	S
For Fluctuating Loads		
Cyclic variation of <i>active power</i> over period	Graph MW/time	S
Cyclic variation of <i>reactive power</i> over period	Graph MVA _r /time	S
Maximum rate of <i>change of active power</i>	MW/s	S
Maximum rate of <i>change of reactive power</i>	MVA _r /s	S
Shortest Repetitive time interval between fluctuations in <i>active power</i> and <i>reactive power</i> reviewed annually	s	S
Largest step <i>change in active power</i>	MW	S
Largest step <i>change in reactive power</i>	MVA _r	S
For commutating power electronic <i>load</i> :		
No. of pulses	Text	S
Maximum <i>voltage</i> notch	%	S
Harmonic current distortion (up to the 50th harmonic)	A or %	S

ATTACHMENT 10 *DESIGN* DATA FOR SMALL *POWER STATIONS* CONNECTED TO THE *DISTRIBUTION SYSTEM*

ATTACHMENT 10: DISTRIBUTION SYSTEM CONNECTED GENERATORS UP TO 10 MW (EXCEPT INVERTOR-CONNECTED GENERATORS UP TO 30 KVA)

Power Station	Data Category
Address	S, R1
Description of power station, for example, is it a green or brownfield site, is there a process steam or heat requirement, any other relevant information	S
Site-specific issues which may affect access to site or design, eg other construction onsite, mine site, environmental issues, soil conditions	S, D
Number of generating units and ratings (kW)	S, D, R1
Type: eg synchronous, induction	S, D, R1
Manufacturer:	D
Connected to the network via: eg inverter, transformer, u/g cable etc	S
Prime mover types: eg reciprocating, turbine, hydraulic, photovoltaic, other	S
Manufacturer	D
Energy source: eg natural gas, landfill gas, distillate, wind, solar, other	S
Total power station total capacity (kW)	S, D, R1
Power station export capacity (kVA)	S, D, R1
Forecast annual energy generation (kWh)	S, D
Normal mode of operation as per clause 3.6.2.3 of Technical Rules ie (a) continuous parallel operation (b) occasional parallel operation (c) short term test parallel operation (d) bumpless transfer, ((1) rapid (2) gradual)	S
Purpose: eg power sales, peak lopping, demand management, exercising, emergency back up	S

ATTACHMENT 10 *DESIGN* DATA FOR SMALL *POWER STATIONS* CONNECTED TO THE *DISTRIBUTION SYSTEM*

Associated Facility Load	
Expected peak load at facility (kW)	S, D, R1
Forecast annual energy consumption (kWh)	S
Construction supply required?	S
Maximum construction power	S
Required connection date	S
Required full operation date	S
Expected life	S
Additional Information Required	
(1) proposed arrangement & site layout of the power station including prime movers, generators, transformers, synchronising circuit breakers and lockable disconnect device. Each component should be identified so that the plan can be cross-referenced to the data provided.	S, D
(2) single line diagram & earthing configuration	S, D, R2
(3) details of generator maximum kVA output over 60 second interval	S, D, R2
(4) a typical 24 hour load power curve measured at 15 minute intervals or less	S, D, R2
(5) calculation of expected maximum symmetrical 3 phase fault current contribution	S, D,
(6) Data on power quality characteristics for wind generators (including flicker and harmonics) to IEC 61400-21	S, D, R2
(7) where required by Western Power, aggregate data required for performing stability studies in accordance with clause 3.2.16 & 3.3.3 and results of preliminary studies (if available)	D

ATTACHMENT 10 *DESIGN DATA FOR SMALL POWER STATIONS CONNECTED TO THE DISTRIBUTION SYSTEM*

Transformers¹		
Item	Unit	Data Category
Identifier ²		
Number of windings	Number	S
Rated MVA of each winding	MVA	S, D
Principal tap rated voltages	kV/kV	S
Positive sequence impedances (each wdg) ³	(a+jb)%	D, R1
Negative sequence impedances (each wdg) ³	(a+jb)%	D, R1
Zero sequence impedances (each wdg) ³	(a+jb)%	D,R1
Tapped winding	Text or diagram	S
Tap change range	kV-kV	D
Tap change step size	%	D
Number of taps	Number	D
Tap changer type, on/off load	On/Off	S
Tap change cycle time	S	D
Vector group	Text or diagram	S
Attachments required		
Earthing arrangement		S, D

Note 1: A separate data sheet is required for each transformer.

Note 2: Where there is more than one transformer, the identifier should be the same as used on the single line diagram.

Note 3: Base must be clearly stated.

ATTACHMENT 10 *DESIGN* DATA FOR SMALL *POWER STATIONS* CONNECTED TO THE *DISTRIBUTION SYSTEM*

Synchronous Generators¹		
Item	Unit	Data Category
Identifier ²		
Make	Text	D
Model	Text	D
Rated kVA	kVA	S, D, R1
Nominal terminal voltage	kV	D
Number of pole-pairs	No	
Speed	rpm	
Rated kW (sent out)	kW (sent out)	S, D, R1
Minimum load (ML)	kW (sent out)	D, R1
Inertia constant (H) for generator only	kW-sec/rated kVA	D, R1
Inertia constant (H) for all rotating masses connected to the generator shaft (for example, generator, turbine, etc). Include gearbox (if any)	kW-sec/rated kVA	D, R1
Short circuit ratio		D, R1
Neutral earthing impedance ³	(a+jb)%	D, R1
Sequence Impedances (saturated)		
Zero sequence impedance ³	(a+jb)%	D, R1
Negative sequence impedance ³	(a+jb)%	D, R1
Reactances (saturated)		
Direct axis transient reactance ³	%	D, R1
Direct axis sub-transient reactance ³	%	D, R1
Reactive capability (at machine terminals)		
Maximum lagging (overexcited) reactive power at rated kW	kVAr export	S, D, R2
Maximum leading (underexcited) reactive power at rated kW	kVAr import	S, D, R2
Lagging reactive short time capability at rated kW, terminal voltage and speed	kVAr for time	D, R1

ATTACHMENT 10 *DESIGN DATA FOR SMALL POWER STATIONS CONNECTED TO THE DISTRIBUTION SYSTEM*

Synchronous Generators (continued)		
Attachments		
Capability chart (Indicate effect of temperature and voltage)	Graphical data	S, D, R1

- Note 1: A separate data sheet is required for each generator.
 Note 2: Where there is more than one generator, the identifier should be the same as used on the single line diagram.
 Note 3: Base must be clearly stated

Induction Generators¹		
Item	Unit	Data Category
Identifier ²		
Make	Text	D
Model	Text	D
Rated kVA	kVA	S, D, R1
Rated kW (sent out)	kW (sent out)	S, D, R1
Reactive consumption at rated kW	kVAr	S, D, R1
Nominal terminal voltage	kV	D
Synchronous speed	rpm	D
Rated speed	rpm	D, R1
Maximum speed	rpm	D, R1
Rated frequency	Hz	D
Single or (effectively) double cage machine	Text	D, R1
Generator reactances (saturated)		
Transient reactance ²	%	D, R1
Subtransient reactance ²	%	D, R1
Control: network commutated or self commutated	Text	S, R1
Attachments		
Curves showing torque, power factor, efficiency, stator current, kW output versus slip (+ and -).	Graphical Data	S, D, R1

- Note 1: A separate data sheet is required for each generator.
 Note 2: Base must be clearly stated.
 Note 2: Where there is more than one generator, the identifier should be the same as used on the single line diagram.

ATTACHMENT 10 *DESIGN DATA FOR SMALL POWER STATIONS CONNECTED TO THE DISTRIBUTION SYSTEM*

Note 2: Where there is more than one generator, the identifier should be the same as used on the single line diagram.

Inverter-Connected Generators¹		
Item	Unit	Data Category
Identifier ²		
Make	text	D
Model	text	D
Maximum kVA output over a 60 s interval	kVA	S, D, R1
Maximum fault current contribution	kA rms symmetrical	S, D, R1
Control modes (voltage, power factor)	text	S, D, R1
Attachments		
Reactive capability curve	Graphical Data	S, D, R1
Long-term flicker factor for generator ³		S, D, R2
Long term flicker factor for windfarm ³		S, D, R2
Harmonics current spectra ³		S, D, R2

Note 1: A separate data sheet is required for each generator.

Note 2: Where there is more than one generator, the identifier should be the same as used on the single line diagram.

Note 3: In accordance with IEC 61400-21.

ATTACHMENT 10 *DESIGN DATA FOR SMALL POWER STATIONS CONNECTED TO THE DISTRIBUTION SYSTEM*

Wind Turbine/Wind Farm		
Item	Unit	Data Category
Flicker factors in accordance with IEC61400-21	Text / Diagram	S, D, R2
Annual average wind speed	metre/sec	S
Harmonics current spectra	Text / Diagram	S, D, R2
Attachments		
A typical 24 hour power curve measured at 15-minute intervals or better if available		S, D,R2
Startup profile kW,kVAr vs time for individual wind turbine		S, D, R2
Startup profile kW, kVAr vs time for wind farm total		S, D, R2
kW, kVAr vs time profiles for individual wind turbine under normal ramp up and ramp down conditions		S, D, R2
High wind shutdown profile kW, kVAr vs time for individual wind turbine		S, D, R2
High wind shutdown profile kW, kVAr vs time for wind farm total		S, D, R2
Low wind shutdown profile kW, kVAr vs time for individual wind turbine		S, D, R2
Low wind shutdown profile kW, kVAr vs time for wind farm total		S, D, R2
Power curve kW vs wind speed		S, D, R2
Spatial arrangement of wind farm		S, D, R1

ATTACHMENT 11 - TEST SCHEDULE FOR SPECIFIC PERFORMANCE VERIFICATION AND MODEL VALIDATION**A11.1 General**

- (a) Recorders must be calibrated/checked prior to use.
- (b) Recorders must not interact with any *equipment* control functions.
- (c) One chart recorder must be used to provide on site monitoring and rapid evaluation of key quantities during tests even though a digital recorder may be used.

A11.2 Recorder Equipment

Signals shall be digitally recorded and processed and require:

- (a) an analogue to digital conversion with at least 12 bit accuracy at full scale;
- (b) a sampling rate of at least 3000 samples per second (i.e. 3kHz) for up to 10 seconds unless specified otherwise;
- (d) departure from linearity of no more than 0.1% in the slope of normalised output versus input. Normalised means value/full range value; and
- (e) DC offset errors not greater than 0.05% of full scale in the analogue circuitry.

A11.3 Frequency response

- (a) A minimum bandwidth of DC - 10kHz is required (0dB at DC, -3dB at 10kHz). Suitable filtering is required to eliminate aliasing errors.
- (b) For relatively slowly changing signals (such as main exciter quantities, transducers for MW output etc) a recording device bandwidth of DC - 100Hz is required.
- (c) All test results required in rms values are to be derived at a minimum rate of 100 samples per second.

A11.4 Signal Requirements and Conditioning

- (a) Suitable input signal level must be used and allowance must be made for excursions during transients.
- (b) Subtraction of an appropriate amount of floating DC from input signals such as stator *voltage* must be provided so that any perturbations are clearly observable on an on-site chart recorder.
- (c) Galvanic isolation and filtering of input signals must be provided whenever necessary.

A11.5 Form of Test Results

These must consist of:

ATTACHMENT 11 – TEST SCHEDULE FOR SPECIFIC PERFORMANCE VERIFICATION AND MODEL VALIDATION

- (a) a brief log showing when tests were done (time, date, test alphanumeric identification);
- (b) chart recordings appropriately annotated;
- (c) relevant schematics of *equipment* and the local *transmission system* configuration;
- (d) lists of data collected manually (eg meter readings);
- (e) data on Microsoft Excel spreadsheets;
- (f) SCADA type printouts showing the *User's power system* configuration at the start of, end of, and any other appropriate time during the test sequence; and
- (g) other relevant data logger printouts (from other than the recorder equipment referred to in section A10.2).

A11.6 Test Preparation and Presentation of Test Results

Information/Data Prior to Tests

- (a) A detailed schedule of tests agreed by the *Network Service Provider*. The schedule must list the tests, when each test is to occur and whose responsibility it will be to perform the test.
- (b) Schematics of *equipment* and subnetworks plus descriptive material necessary to draw up/agree upon a schedule of tests
- (c) Most up to date relevant technical data and parameter settings of *equipment* as specified in Attachment 4 to Attachment 9.

Test Notification

- (a) A minimum of 15 *business day* prior notice of test commencement must be given to the *Network Service Provider* for the purpose of arranging witnessing of tests.
- (b) The *Network Service Provider's representative* must be consulted about proposed test schedules, be kept informed about the current state of the testing program, and give permission to proceed before each test is carried out.
- (c) Unless agreed otherwise, tests must be conducted consecutively.

Test Results

- (a) Test result data must be presented to the *Network Service Provider* within 10 *business days* of completion of each test or test series.
- (b) Where test results show that generator performance does not comply with the requirements of these *Rules* or the *access contract* or *connection agreement* it will be necessary to rectify problem(s) and repeat tests.

A11.7 Quantities to be Measured

- (a) Wherever appropriate and applicable for the tests, the following quantities must be measured on the machine under test using either the same recorders or, where different recorders are used, time scales must be synchronised to within 1 msec:

Generating unit and Excitation System

- 3 stator L-N terminal *voltages*
- 3 stator terminal currents
- *Active power* MW
- *Reactive power* MVar
- *Generating unit* rotor field *voltage*
- *Generating unit* rotor field current
- Main exciter field *voltage*
- Main exciter field current
- AVR reference *voltage*
- *Voltage* applied to AVR summing junction (step etc)
- *Power system* stabiliser output
- DC signal input to AVR

Steam Turbine

- Shaft speed
- *Load* demand signal
- Valve positions for control and interceptor valves
- Turbine control set point

Gas turbine

- Shaft speed (engine)
- Shaft speed of turbine driving the *generating unit*
- Engine speed control output
- Free turbine speed control output

ATTACHMENT 11 – TEST SCHEDULE FOR SPECIFIC PERFORMANCE VERIFICATION AND MODEL VALIDATION

- *Generating unit*-compressor speed control output
- Ambient/turbine air inlet temperature
- Exhaust gas temperature control output
- Exhaust temperature
- Fuel flow
- Turbine control / *load* reference set point

Hydro

- Shaft speed
 - Gate position
 - Turbine control /*load* reference set point
- (b) The *Network Service Provider* must specify test quantities for power *equipment* other than those listed above, such as those consisting of wind, solar and fuel cell *generating units* which may also involve AC/DC/AC power conversion or DC/AC power inverters.
- (c) Additional test quantities may be requested and advised by the *Network Service Provider* if other special tests are necessary.
- (c) Key quantities such as stator terminal *voltages*, currents, *active power* and *reactive power* of other *generating units* on the same site and also *interconnection* lines with the *transmission or distribution system* (from control room readings) before and after each test must also be provided.

SCHEDULE OF TESTS

Table A11.1 - Schedule of tests

TEST DESCRIPTION			
Test No	General Description	<i>Changes Applied</i>	Test Conditions
C1	Step <i>change</i> to AVR voltage reference with the <i>generating unit</i> on open circuit	(a) +2.5 % (b) -2.5 % (c) +5.0 % (d) -5.0 %	<ul style="list-style-type: none"> • nominal stator terminal volts
C2A	Step <i>change</i> to AVR voltage reference with the <i>generating unit connected</i> to the system. (with the <i>Power system Stabiliser</i> out of service) <i>Generating unit</i> output levels: (i) 50% rated MW, and (ii) 100% rated MW	(a) +1.0 % (b) -1.0 % (c) +2.5 % (d) -2.5 % (e) +5.0 % (f) -5.0 % repeat (e) & (f) twice see note i. below	<ul style="list-style-type: none"> • nominal stator terminal volts • unity or lagging <i>power factor</i> • system base <i>load</i> OR typical conditions at the local <i>equipment</i> and typical electrical connection to the <i>transmission or distribution system</i> • tests for (i) must precede tests for (ii) • smaller step <i>changes</i> must precede larger step <i>changes</i>
C2B	As for C2A but with the PSS in service	Same as in C2A	Same as in C2A

ATTACHMENT 11 – TEST SCHEDULE FOR SPECIFIC PERFORMANCE VERIFICATION AND MODEL VALIDATION

TEST DESCRIPTION			
Test No	General Description	Changes Applied	Test Conditions
C3A	<p>Step <i>change</i> to AVR voltage reference with the <i>generating unit connected</i> to the system.</p> <p>(With PSS out of service)</p> <p>System Conditions :</p> <p>(i) system minimum <i>load</i> with no other <i>generation</i> on the same bus OR relatively weak connection to the <i>transmission or distribution system</i>, and</p> <p>(ii) system maximum <i>load</i> and maximum <i>generation</i> on same bus OR relatively strong connection to the <i>transmission or distribution system</i></p>	<p>(a) +5 %</p> <p>(b) –5 %</p> <p>repeat (a) & (b) twice;</p> <p>see note v. below</p>	<ul style="list-style-type: none"> • nominal stator terminal volts • unity or lagging <i>power factor</i> • <i>Generating unit</i> output at 100% rated MW
C3B	As for C3A but with the PSS in service	Same as in C3A	As for C3A.
C4	<p>Step <i>change</i> of MVA on the <i>transmission or distribution system</i></p> <p>PSS Status :</p> <p>(i) PSS in service, and</p> <p>(ii) PSS out of service</p>	<p>Switching in and out of</p> <p><i>Transmission or distribution lines</i></p> <p>(nominated by the <i>Network Service Provider</i>)</p>	<ul style="list-style-type: none"> • nominal stator terminal volts • unity or lagging <i>power factor</i> • system base <i>load</i> OR typical conditions at the local <i>equipment</i> and typical electrical connection to the <i>transmission or distribution system</i>

ATTACHMENT 11 – TEST SCHEDULE FOR SPECIFIC PERFORMANCE VERIFICATION AND MODEL VALIDATION

TEST DESCRIPTION			
Test No	General Description	Changes Applied	Test Conditions
			<p><i>system</i></p> <ul style="list-style-type: none"> • <i>generating unit</i> output at 50% rated MW
C5	<i>load rejection (real power)</i>	<p>(a) 25 % rated MW</p> <p>(b) 50 % rated MW</p> <p>(c) 100 % rated MW</p> <p>see notes below</p>	<ul style="list-style-type: none"> • nominal stator terminal volts • unity <i>power factor</i> • smaller amount must precede larger amount of <i>load rejection</i>
C6	steady state over-excitation limiter (OEL) operation	<p>MVAr outputs at OEL setting</p> <p>slow raising of excitation to just bring OEL into operation</p> <p>see notes below</p>	<ul style="list-style-type: none"> • 100% MW output • 75% MW output • 50% MW output • 25% MW output • min. MW output
C7	steady state under-excitation limiter (UEL) operation	<p>MVAr outputs at UEL setting</p> <p>slow lowering of excitation to just bring UEL into operation</p>	<ul style="list-style-type: none"> • 100% MW output • 75% MW output • 50% MW output • 25% MW output

ATTACHMENT 11 – TEST SCHEDULE FOR SPECIFIC PERFORMANCE VERIFICATION AND MODEL VALIDATION

TEST DESCRIPTION			
Test No	General Description	Changes Applied	Test Conditions
		see notes below	<ul style="list-style-type: none"> min. MW output
C8	Manual variation of <i>generating unit open circuit voltage</i>	Stator terminal volt (Ut) (a) increase from 0.5 pu to 1.1 pu (b) decrease from 1.1 pu to 0.5 pu see notes below	<ul style="list-style-type: none"> in 0.1 pu step for Ut between 0.5-0.9 pu in 0.05 pu step for Ut between 0.9-1.1 pu
C9	MVAR capability at full MW output. System maximum <i>load</i> and maximum <i>generation</i> . Test conducted with as high an ambient temperature as possible.	<i>Generating unit</i> MW and MVAR output levels set to 100% of rated values and maintained for one hour.	<ul style="list-style-type: none"> System maximum <i>load</i> and <i>generation</i> Ambient temperature as high as possible

Notes:

- i. for tests C2A and C2B care must be taken not to excite large or prolonged oscillations in MW etc. Therefore, smaller step *changes* must always precede larger step *changes* to avoid such oscillations.
- ii. The Figure A11.1 below shows the step *changes* referred to in the schedule of tests given above. An example is given of a +5% step to the summing junction and then a -5% step. Removal of the +5% ("-5%") step is deemed to be a -5% step.

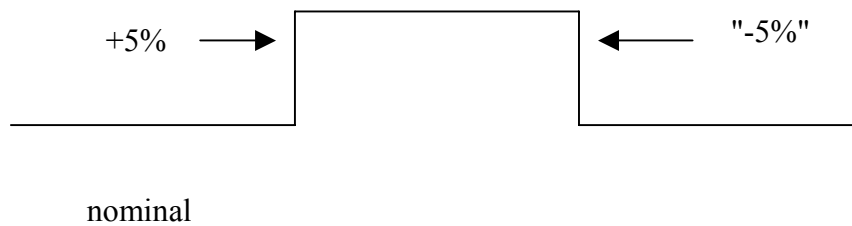

Figure A11.1 - Application of Step Signal

Unless specified otherwise the "-5%" step method shown in Figure A11.1 is used.

- iii. for test C5, the instantaneous overspeed *protection* must be set at an agreed level depending on unit capability.
- iv. "system" means "*power system*"
- v. OR a lower step *change*, with a larger safety margin, as agreed by the *Network Service Provider*
- vi. tests C1, C6, C7 and C8 need not be witnessed by the *Network Service Provider*

SPECIAL SYSTEM TESTS THAT MAY BE REQUESTED

Table A11.2 – Schedule of special system tests

Test No	TEST DESCRIPTION		
	General Description	Changes Applied	Test Conditions
S1	<i>Load rejection (reactive power)</i>	(a) -30 % rated MVAR (b) +25 % rated MVAR see notes below	<ul style="list-style-type: none"> nominal stator terminal volts 0 or minimum MW output
S2	<i>Load rejection (reactive power)</i>	(a) -30 % rated MVAR see notes below	<ul style="list-style-type: none"> nominal stator terminal volts Excitation on Manual Control
S3	<i>Step change of MVAR on the transmission system</i>	Switching in and out of (a) a <i>transformer</i> (b) a <i>reactor</i> (c) a capacitor	<ul style="list-style-type: none"> parallel <i>transformers</i> on staggered taps <p>others as determined by WPC</p>
S4	<i>Islanding of a <u>subsystem</u> consisting of <u>User's generating units plus load</u> with export of power by means of a link to the <i>Network Service Provider's</i> main transmission system.</i>	opening of the link	<ul style="list-style-type: none"> 5-10% of <i>generated</i> MW exported by means of the link 90-95% of <i>generated</i> MW used by the subsystem's <i>load</i>
S5	<i>AVR/OEL changeover</i>	<i>transformer tap change</i> OR small step to AVR voltage reference	<ul style="list-style-type: none"> initially under AVR control at lagging <i>power factor</i> but close to OEL limit
S6	<i>AVR/UEL changeover</i>	<i>transformer tap change</i> OR small step to AVR voltage reference	<ul style="list-style-type: none"> initially under AVR control at leading <i>power factor</i> but close to UEL

ATTACHMENT 11 – TEST SCHEDULE FOR SPECIFIC PERFORMANCE VERIFICATION AND MODEL VALIDATION

		<i>voltage</i> reference	limit
S7	Testing of a FACTS device (SVC, TCR, STATCOM, etc)	<ul style="list-style-type: none"> • step <i>change</i> to reference value in the summing junction of a control element • line switching • others as appropriate 	<ul style="list-style-type: none"> • MVA initial conditions in lines as determined by WPC
S8	Tripping of an adjacent <i>generating unit</i>	tripping of <i>generating unit(s)</i>	<ul style="list-style-type: none"> • initial <i>generating unit loading</i> as agreed
S9	Variable <i>frequency</i> injection into the AVR summing junction (with PSS out of service)	0.01-100 rad/sec see notes below	<ul style="list-style-type: none"> • as determined by WPC
S10	Step <i>change</i> to governor/ <i>load</i> reference	(a) 2.5 % step increase in MW demand signal (b) 2.5 % decrease in MW demand signal (c) equivalent of 0.05Hz subtracted from the governor speed ref. (d) equivalent of 0.1 Hz added to governor speed reference see notes below	<ul style="list-style-type: none"> • <i>equipment</i> output at 50-85% of rated MW • others as agreed with the <i>Network Service Provider</i>
S11	Overspeed capability to stay in the range of 52.0 to 52.5Hz for a minimum of 6 seconds	(a) Digital governor: use software, where practical, to put a step in the speed reference of the turbine governor such that the target speed is 52.0Hz and the overshoot in speed remains above	<ul style="list-style-type: none"> • Unsynchronised unit at rated speed and no <i>load</i>

ATTACHMENT 11 – TEST SCHEDULE FOR SPECIFIC PERFORMANCE VERIFICATION AND MODEL VALIDATION

		<p>52Hz and in the range 52-52.5Hz for about 6 sec</p> <p>(b) Use a manual control to raise speed from 50Hz so as to stay in the 52 to 52.5 Hz range for a minimum of 6 sec</p> <p>(c) Where it is practical, use a function <i>generating unit</i> to inject an analogue signal in the appropriate summing junction, so that the turbine stays in the 52-52.5 Hz range for a minimum of 6 sec.</p>	
S12	Underspeed capability	To be proposed by the manufacturer	
S13	Any other test to demonstrate compliance with a declared or registered <i>equipment</i> performance characteristic.	To be advised	

Notes:

- i. For tests S1(a) and S2 the VAr absorption must be limited so that field *voltage* does not go below 50% of its value at rated *voltage* and at no *load* (i.e. rated stator terminal *voltage* with the *generating unit* on open circuit).
- ii. For test S1(b) the VAr *load* must not allow stator terminal *voltage* to exceed 8% *overvoltage* (i.e. 108% of rated value) as a result of the applied *change*.
- iii. For test S1 and S2, the instantaneous *overvoltage protection* must be operative and set at an agreed level greater than or equal to 10% *overvoltage*.

ATTACHMENT 11 – TEST SCHEDULE FOR SPECIFIC PERFORMANCE VERIFICATION AND MODEL VALIDATION

- iv. For test S2, it may be easier to use AVR control first and then *change* to manual (provided the *change* is "bumpless") before the unit trips.
- v. For test S9, care has to be taken not to excite electromechanical resonances (eg poorly damped MW swings) if the machine is on line.
- vi. For the tests S10 *equipment* characteristics may require the *changes* be varied from the nominal values given. Larger *changes* may be considered in order to more accurately determine *equipment* performance.

For test S5 a positive step is applied of X% from the sub-OEL value. But for test S6 a –Y% step from the sub-UEL value as shown in Figure A11.2 is required.

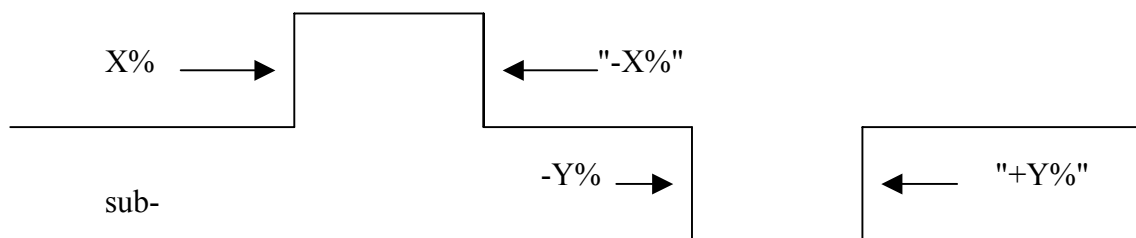

Figure A11.2 - Application of Step Signal

ATTACHMENT 12 - TESTING AND COMMISSIONING OF SMALL POWER STATIONS CONNECTED TO THE DISTRIBUTION SYSTEM**A12.1 Application**

This attachment specifies the specific requirements for the certification, testing and commissioning of *generating units* connecting to the *distribution system* in accordance with clause 3.6 and for which the provisions of clause 4.2 apply.

A12.2 Certification

The *Generator* must provide certification by a chartered professional engineer with National Professional Engineers' Register Standing in relevant areas of expertise that the facilities comply with the *Rules*, the relevant *connection agreement*, good engineering practice and relevant standards. The certification must confirm that the following have been verified:

- The single line diagram approved by the *Network Services Provider* has been checked and accurately reflects the installed electrical system;
- All required switches present and operate correctly as per the single line diagram;
- The specified generation *facility* is the only source of power that can be operated in parallel with the distribution network;
- The earthing systems complies with Australian Standards AS3000 and AS2067 and do not rely upon the *Network Service Provider's* earthing system;
- Electrical equipment is adequately rated to withstand specified network fault levels;
- All protection apparatus (that serves a network protection function, including backup function) complies with IEC 60255 and has been correctly installed and tested. Interlocking systems specified in the *connection agreement* have been correctly installed and tested;
- The islanding protection operates correctly and disconnects the small *power station* from the network within 2 seconds;
- Synchronizing and auto-changeover *equipment* has been correctly installed and tested;
- The delay in reconnection following restoration of normal supply is greater than 1 minute;
- The *protection* settings specified in the *connection agreement* have been approved by the *Network Services Provider* and are such that satisfactory coordination is achieved with the *Network Service Provider's protection systems*;
- Provision has been made to minimise the risk of injury to personnel or damage to *equipment* that may be caused by an out-of-synchronism fault;
- *Control systems* have been implemented to maintain *voltage*, *active power* flow and *reactive power flow* requirements for the *connection point* as specified in the *connection agreement*;
- Systems or procedures are in place such that the testing, commissioning, operation and maintenance requirements specified in the *Rules* and the *connection agreement* are adhered to; and
- Operational settings as specified.

A12.3 Pre-commissioning

Commissioning may occur only after the installation of the metering *equipment*.

A12.4 Commissioning Procedures

The commissioning of a *generating unit* shall include the checks and tests specified in clauses A12.5 to A12.14.

A.12.5 Operating Procedures

- The single line diagram shall be checked to confirm that it accurately reflects the installed plant;
- The documented operating procedures agreed with the *Network Service Provider* and have been implemented as agreed;
- Naming, numbering and labelling of plant agreed with the *Network Service Provider* has been followed; and
- Operating personnel are familiar with the agreed operating procedures and all requirements to preserve the integrity of the protection settings and interlocks and the procedures for subsequent changes to settings.

A12.6 Protection Systems

- *Protection apparatus* has been manufactured and installed to required standards;
- The settings and functioning of *protection systems* required for the safety and integrity of the *distribution system* operate correctly (at various power levels) and coordinate with the *Network Service Provider's protection systems*. This will include the correct operation of the *protection systems* specified in the *connection agreement* and, in particular,
 - islanding *protection* and coordination with automatic reclosers export/import limiting *protection*;
 - automatic changeover schemes; and
 - fail-safe generator shutdown for auxiliary *supply* failure or loss of *distribution system supply*; and
- Any required security measures for protection settings are in place.

A12.7 Switchgear Installations

- Switchgear, instrument transformers and cabling have been manufactured, installed and tested to required standards.

A12.8 Transformers

- Transformer(s) has been installed and tested to required standards; and
- Transformer parameters (nameplate inspection) are as specified and there is correct functioning of on-load tap changing (when supplied).

A12.9 Earthing

- The earthing connections and value(s) of earthing electrode impedance are correct; and

- The earthing systems comply with Australian Standards AS3000 and AS2067 and do not rely upon the *Network Service Provider's* earthing system

A12.10 *Generating Units*

A12.10.1 Unsynchronised/ disconnected

- *Generating unit* parameters are as specified (nameplate inspection);
- *Generating units* have been manufactured to meet the requirements of the *Rules* for riding through *power system* disturbances;
- Earthing arrangements of the generating unit are as specified;
- Correct functioning of automatic voltage regulator for step changes in error signals (when specified);
- Achievement of required automatic voltage regulator response time (when specified); and
- Correct functioning of automatic synchronizing equipment prior to synchronisation.

A.12.10.2 Voltage Changes

- Voltage transients at the *connection point* on connection are within specified limits; and
- Step changes in *voltage* on connection and disconnection (both before and after tap-changing) are within required limits.

A12.10.3 Synchronous *Generating Units*

- The *generating unit* is capable of specified sustained output of *real power* (when required);
- The *generating unit* is capable of required sustained generation and absorption of *reactive power*, (when required);
- Correct operation of over- and under-excitation limiters (when required); and
- Response time in constant *power factor* mode is within limits (when required).

A.12.10.4 Asynchronous *Generating Units*

- Starting inrush current is within specified limits;
- *Power factor* during starting and normal operation is within specified limits; and
- Rating and correct operation of *reactive power* compensation *equipment*.

A.12.10.5 Inverter connected *Generating Units*

- *Power factor* during starting and normal operation is within specified limits; and
- Rating and correct operation of *reactive power* compensation *equipment*.

A.12.10.6 Harmonics and Flicker

- Network flicker and harmonics levels before and after connection and confirmation that limits have not been exceeded (not required for directly connected rotating machines).

A12.10.7 Additional Requirement for Wind Farms

ATTACHMENT 12 TESTING AND COMMISSIONING OF *SMALL POWER STATIONS* CONNECTED TO THE
DISTRIBUTION SYSTEM

- The level of variation in the output of a wind *generating unit* or wind farm is within the limits specified in the *connection agreement*.

A12.11 Interlocks and Intertripping

- Correct operation of interlocks, check synchronizing, remote control, permissive interlocking and intertripping.

A12.12 Voice and Data Communications

- Correct operation of primary and back up voice and data communications systems

A12.13 Signage and Labelling

- Signage and labelling comply with that specified in the relevant *connection agreement*.

A12.14 Additional Installation Specific Tests

- The *Network Service Provider* may specify additional installation specific tests and inspections in respect of the physical and functional parameters that are relevant for parallel operation of the small *power station* and coordination with the *distribution system*.

A12.15 Routine Testing

- The *Generator* must test *generating unit protection systems*, including backup functions, at regular intervals not exceeding 3 years for unmanned sites and 4 years for manned sites and keep records of such tests.

A12.16 Non-routine Testing

- The *Network Service Provider* may inspect and test the small *power station* from to re-confirm its correct operation and continued compliance with the *Rules, connection agreement*, good engineering practice and relevant standards. In the event that the *Network Service Provider* considers that the installation poses a threat to safety, to *quality of supply* or to the integrity of the *distribution system* it may *disconnect* the *generating equipment*.

This page has been left blank intentionally.