

ELECTRICITY INDUSTRY ACT

**ELECTRICITY INDUSTRY (WHOLESALE ELECTRICITY
MARKET) REGULATIONS 2004**

WHOLESALE ELECTRICITY MARKET RULES

Version 2.3

3 April 2006

Disclaimer

This version of the Wholesale Electricity Market Rules reflects the 5 October 2004 Gazetted Wholesale Electricity Market Rules modified to include changes gazetted on 9 September 2005, 25 October 2005 (including changes to the Top and Spill Rules of Appendix 8), and 31 March 2006. This version is provided for information on the proposed amendments only and has no legal standing. The Office of Energy disclaims any responsibility for any liability arising from any act done or omission made in reliance on this version of the Wholesale Electricity Market Rules.

For the version of the Wholesale Electricity Market Rules that is currently in force under the Electricity Industry (Wholesale Electricity Market) Regulations 2004 please refer to the Wholesale Electricity Market Rules and any subsequent amendments gazetted in the Western Australia Government Gazette.

Note

Changes made between the version of the Wholesale Electricity Market Rules gazetted on 5 October 2004 and Version 2.2 (inclusive) are shaded grey. Additional changes made to this Version 2.3 relative to Version 2.2 are shaded light blue.

Table of Contents

TABLE OF CONTENTS.....	V
1. INTRODUCTION	1
The Market Rules.....	1
1.1. Authority of Market Rules	1
1.2. Objectives.....	1
Conventions.....	1
1.3. Electricity Industry Act and Regulations	1
1.4. Other rules of interpretation	1
1.5. Subservient Documents	3
1.6. Notices	4
1.7. Publication.....	4
Staging.....	4
1.8. Staging of the Market Rules.....	4
1.9. Transition	5
2. ADMINISTRATION.....	8
Functions and Governance	8
2.1. Independent Market Operator	8
2.2. System Management.....	9
2.3. The Market Advisory Committee.....	10
Market Documents.....	12
2.4. Market Rules	12
2.5. Rule Change Proposals	13
2.6. Fast Track Rule Change Process	16
2.7. Standard Rule Change Process.....	17
2.8. Review of IMO Rule Amendment Decisions, Ministerial Approval and Coming into Force of Rule Amendments.....	18
2.9. Market Procedures.....	21
2.10. Procedure Change Process	22
2.11. Coming into Force of Procedure Amendments.....	24
Monitoring, Enforcement and Audit.....	25
2.12. Standard of Performance.....	25
2.13. Market Rule Compliance Monitoring and Enforcement	26
2.14. Audit	31
2.15. Monitoring and Reporting Protocols	32
2.16. Monitoring the Effectiveness of the Market	34

Reviewable Decisions and Disputes	41
2.17. Reviewable Decisions	41
2.18. Disputes.....	44
2.19. First Stage Dispute Resolution.....	45
2.20. Second Stage Dispute Resolution.....	46
Market Consultation.....	46
2.21. Market Consultation	46
Budgets and Fees.....	47
2.22. Determination of the IMO’s budget	47
2.23. Determination of System Management’s budget	50
2.24. Determination of Market Fees.....	53
2.25. Payment of Market Participant Fees.....	54
Maximum and Minimum Prices and Loss Factors.....	55
2.26. Economic Regulation Authority Approval of Maximum and Minimum Prices	55
2.27. Determination of Loss Factors	56
Participation and Registration	58
2.28. Rule Participants.....	58
2.29. Facility Registration Classes	61
2.30. Facility Aggregation	63
2.30A Exemption from Funding Spinning Reserve.....	65
2.30B Intermittent Load.....	66
2.30C. Rule Commencement and Registration Data	72
2.31. Registration Process.....	73
2.32. Rule Participant Suspension and Deregistration	78
2.33. The Registration Forms.....	80
2.34. Standing Data	83
Communications and Systems Requirements	86
2.35. Dispatch Systems Requirements	86
2.36. Market Systems Requirements.....	86
Prudential Requirements.....	87
2.37. Credit Limit	87
2.38. Credit Support	89
2.39. Trading Limit	91
2.40. Outstanding Amount.....	91
2.41. Trading Margin.....	92
2.42. Margin Call	92
2.43. Prudential Market Procedure.....	93
Emergency Powers.....	94
2.44. Minister’s Emergency Powers.....	94
3 POWER SYSTEM SECURITY AND RELIABILITY.....	95

Security and Reliability	95
3.1. SWIS Operating Standards	95
3.2. Technical Envelope, Security and Equipment Limits	95
3.3. Normal Operating State	96
3.4. High Risk Operating State	97
3.5. Emergency Operating State.....	99
3.6. Demand Control	101
3.7. System Restart	102
3.8. Investigating Incidents in the SWIS	102
Ancillary Services	104
3.9. Definitions of Ancillary Services	104
3.10. Ancillary Service Standards	105
3.11. Determining & Procuring Ancillary Service Requirements	107
3.12. Ancillary Service Dispatch	109
3.13. Payment for Ancillary Services.....	110
3.14. Ancillary Service Cost Recovery	111
3.15. Review of Ancillary Service Requirements Process and Standards.....	111
Medium and Short Term Planning	112
3.16. Medium Term PASA	112
3.17. Short term PASA	115
3.18. Outage Scheduling.....	117
3.19. Outage Approval	127
3.20. Outage Recall	131
3.21. Forced Outages.....	131
Commissioning Tests	132
3.21A Commissioning Tests.....	132
Decommitment and Reserve Capacity Obligations	134
3.21B. Decommitment and Reserve Capacity Obligations	134
Settlement Data	135
3.22. Settlement Data	135
4 RESERVE CAPACITY RULES	138
The Reserve Capacity Cycle	138
4.1. The Reserve Capacity Cycle	138
The Reserve Capacity Expression of Interest	144
4.2. The Reserve Capacity Expression of Interest Process.....	144
4.3. Information to be Included in Requests for Expression of Interest.....	146
4.4. Information to be Included in Expression of Interests.....	148
The Long Term SWIS Capacity Requirements	149
4.5. Long Term Projected Assessment of System Adequacy	149
4.6. Reserve Capacity Requirements.....	156

Certification of Reserve Capacity	157
4.7. The Reserve Capacity Information Pack	157
4.8. Who Can Apply for Certification of Reserve Capacity.....	158
4.9. Process for Applying for Certification of Reserve Capacity	158
4.10. Information Required for the Certification of Reserve Capacity.....	161
4.11. Setting Certified Reserve Capacity.....	165
4.12. Setting Reserve Capacity Obligations	168
Commitment of Capacity to Auction or Bilateral Trade	172
4.13. Reserve Capacity Security	172
4.14. Market Participant Auction and Bilateral Trade Declaration	177
Reserve Capacity Auctions	181
4.15. Confirmation or Cancellation of Reserve Capacity Auctions.....	181
4.16. The Maximum Reserve Capacity Price	182
4.17. Reserve Capacity Auction Submission Process	184
4.18. Reserve Capacity Offer Format.....	185
4.19. Reserve Capacity Auction Clearing.....	186
Capacity Credits	187
4.20. Capacity Credits	187
Special Price Arrangements	189
4.21. Short Term Special Price Arrangements.....	189
4.22. Long Term Special Price Arrangements.....	190
4.23. Capacity Credits and Force Majeure	193
4.23A. Capacity Credits and Facility Registration	193
Addressing Shortages of Reserve Capacity	194
4.24. Supplementary Reserve Capacity.....	194
Testing, Monitoring and Compliance	201
4.25. Reserve Capacity Testing.....	201
4.26. Financial Implications of Failure to Satisfy Reserve Capacity Obligations	205
4.27. Reserve Capacity Performance Monitoring	213
Funding Reserve Capacity Purchased by the IMO	216
4.28. Funding Reserve Capacity Purchased by the IMO.....	216
Intermittent Load Refunds	220
4.28A. Intermittent Load Refunds	220
Treatment of New Small Generators	222
4.28B. Treatment of New Small Generators.....	222
Settlement Data	224
4.29. Settlement Data	224
5 NETWORK CONTROL SERVICE PROCUREMENT	227

Network Control Service Tender Process and Timelines	227
5.1. Definitions and Obligations	227
5.2. Network Control Service Procurement Requirements.....	228
5.3. Network Control Service Certification.....	230
5.4. Network Control Service tenders	231
Network Control Service Contracts	234
5.5. Contract Conditions	234
5.6. Network Control Service Contract Compliance Conditions.....	236
5.7. Network Control Service Dispatch.....	237
Payments and Settlement Data	237
5.8. Network Control Service Contracts Payments.....	237
5.9. Settlement Data	239
6. THE ENERGY MARKET	240
Energy Scheduling Timetable and Process	240
6.1. [Blank]	240
6.2. Bilateral Submission Timetable and Process	240
6.2A. Standing Bilateral Submission Timetable and Process.....	242
6.3. [Blank]	242
6.3A. Information to Support the Bilateral and STEM Submission Process	242
6.3B. STEM Submissions Timetable and Process.....	245
6.3C. Standing STEM Submission Timetable and Process.....	246
6.4. The STEM Auction Timetable and Process.....	248
6.5. Resource Plan Submission Timetable and Process	249
6.5A. Balancing Data Submission Timetable and Process.....	250
6.5B. [Blank]	251
6.5C. Standing Resource Plan Submission Timetable and Process.....	251
STEM Submission and Bilateral Submission Formats.....	252
6.6. Format of STEM Submission and Standing STEM Submission Data	252
6.7. Format of Bilateral Submission Data	258
6.8. [Blank]	260
The STEM Auction Process.....	260
6.9. The STEM Auction.....	260
6.10. Suspension of the STEM.....	266
Resource Plans and Balancing Data.....	267
6.11. Format of Resource Plans	267
6.11A. Format of Balancing Data	269
The Dispatch Merit Order	271
6.12. The Dispatch Merit Order	271
Balancing Pricing and Quantities.....	275
6.13. Real Time Dispatch Information.....	275

6.14.	Calculation of MCAP, UDAP and DDAP	275
6.15.	The Dispatch Schedule	277
6.16.	The Metered Schedule	278
6.17.	Balancing Settlement Quantities	279
6.18.	Commitment Compensation.....	284
Market Advisories and Energy Price Limits.....		285
6.19.	Market Advisories	285
6.20.	Energy Price Limits	286
Settlement Data		290
6.21.	Settlement Data	290
7	DISPATCH	291
Data used in the Dispatch Process		291
7.1.	Data Used in the Dispatch Process	291
7.2.	Load Forecasts and Ancillary Service Requirements.....	292
7.3.	Outages	294
7.4.	Resource Plans	294
7.5.	Dispatch Merit Orders and Fuel Declarations.....	295
Dispatch Process.....		296
7.6.	The Dispatch Criteria	296
7.6A.	Scheduling and Dispatch of the Electricity Generation Corporation	299
7.7.	Dispatch Instructions	303
7.8.	Dispatch Instructions Implemented by System Management	306
7.9.	Commitment.....	307
Dispatch Compliance		308
7.10.	Compliance with Resource Plans and Dispatch Instructions	308
Advisories, Balancing Suspension and Reporting.....		310
7.11.	Dispatch Advisories.....	310
7.12.	Status Reports.....	312
Settlement and Monitoring Data		312
7.13.	Settlement and Monitoring Data	312
8	WHOLESALE MARKET METERING.....	315
Metering Data Agents		315
8.1.	Metering Data Agents.....	315
8.2.	Duties of a Metering Data Agent.....	315
Meter Registry.....		315
8.3.	Meter Registry.....	315
Meter Data Submissions		317

8.4.	Meter Data Submission.....	317
8.5.	Notices of Disagreement and Disputed Meter Data	317
8.6.	Format of Meter Data Submissions	317
	Metering Protocol Requirements	318
8.7.	Metering Protocol Requirements.....	318
	Support of Calculations	319
8.8.	Support of Calculations.....	319
9	SETTLEMENT	320
	Introduction.....	320
9.1.	Conventions.....	320
9.2.	Settlement Procedure	321
	Settlement Data	321
9.3.	Data Collection.....	321
9.4.	Capacity Credit Allocation Process	323
9.5.	Format of Capacity Credit Allocation Submissions	326
	Settlement Calculations	327
9.6.	STEM Settlement Calculations for a Trading Week	327
9.7.	The Reserve Capacity Settlement Calculations for a Trading Month	328
9.8.	The Balancing Settlement Calculations for a Trading Day	330
9.9.	The Ancillary Service Settlement Calculations for a Trading Month	331
9.10.	The Commitment and Outage Compensation Settlement Calculations for a Trading Month.....	335
9.10A.	Non-Compliance Charge	336
9.11.	The Reconciliation of Settlement Calculations for a Trading Month	336
9.12.	Network Control Service Calculations for a Trading Month.....	337
9.13.	The Market Participant Fee Settlement Calculations for a Trading Month.....	338
9.14.	The Net Non-STEM Settlement Amount for a Trading Month.....	339
9.15.	The Service Fee Settlement Amount for a Trading Month.....	339
	Settlement Statements.....	340
9.16.	Settlement Cycle Timelines	340
9.17.	STEM Settlement Statements.....	344
9.18.	Non-STEM Settlement Statements.....	345
9.19.	Adjusted Settlement Statements	347
9.20.	Notices of Disagreement	349
9.21.	Settlement Disputes	350
	Invoicing and Payment	351
9.22.	Invoicing and Payment	351
	Default and Settlement in Default Situations.....	352
9.23.	Default.....	352
9.24.	Settlement in Default Situations	355

10	MARKET INFORMATION	360
	Information Policy	360
	10.1. Record Retention	360
	10.2. Information Confidentiality Status	360
	10.3. The Market Web Site	362
	10.4. Information to be Released on Application	363
	Information to be Released via the Market Web Site.....	363
	10.5. Public Information.....	364
	10.6. SWIS Restricted Information.....	369
	10.7. Rule Participant Market Restricted Information	370
	10.8. Rule Participant Dispatch Restricted Information.....	370
11	GLOSSARY.....	372
	APPENDIX 1: STANDING DATA	393
	APPENDIX 2: SPINNING RESERVE COST ALLOCATION	402
	APPENDIX 3: RESERVE CAPACITY AUCTION & TRADE METHODOLOGY....	405
	APPENDIX 4: MAXIMUM RESERVE CAPACITY PRICE METHODOLOGY.....	409
	APPENDIX 4A: INTERMITTENT LOAD INDIVIDUAL RESERVE CAPACITY REQUIREMENTS.....	412
	APPENDIX 5: INDIVIDUAL RESERVE CAPACITY REQUIREMENTS.....	414
	APPENDIX 6: STEM BID ,STEM OFFER AND MCAP PRICE CURVE DETERMINATION.....	418
	APPENDIX 7: DISPATCH SCHEDULE CALCULATION.....	423
	APPENDIX 8: TOP-UP AND SPILL RULES	424
	Appendix 8: Chapter 1 – Introductory.....	425
	Definitions	425
	Interpretation.....	433
	References to a member include its generators and customers	433
	Appendix 8: Chapter 2 – Membership.....	434
	Market service provider is a member	434
	Application for membership	434
	Member must have access contract.....	434
	Amendment of access contract to provide for cross-default in payment	434

Security from <i>applicant</i> if access contract not amended	434
One membership per access contract	435
Membership notice	435
Application disputes	435
When the rules apply to a member (other than the <i>market service provider</i>)	436
Cancelling membership	436
Security from member if access contract not amended	436
Parties may contract inconsistently with these rules	437
Appendix 8: Chapter 3 – TUAS market.....	437
Obligation to provide.....	437
Payment obligation.....	437
Trading electricity and balancing electricity	437
Exit point for spill electricity	438
Entry point for top-up electricity.....	438
Member’s maximum trading requirement	438
Advance notice of likely unavailability.....	439
Nomination of trading amounts	439
Effect of an accepted nomination.....	441
Forecast production data.....	442
Balancing band.....	442
Calculating member’s imbalance	442
Members must maintain adequate generation capacity.....	443
These rules do not affect standby power and ancillary services arrangements	443
Top up and spill calculated on an aggregated basis	444
Relief from obligation to provide trading electricity	444
The TUAS market during a liquids event.....	444
Calculating member’s residual imbalance.....	444
ETR balancing provisions.....	445
Appendix 8: Chapter 4 - Price lists.....	446
Price lists.....	446
Residual imbalance tariff list	447
Determining the price payable	447
High price days	448
Liquids events	448
Trading bands.....	448
The <i>market service provider</i> may offer higher spill prices	448
Replacement of price lists in changed circumstances	448
Appendix 8: Chapter 5 - Pricing principles and review	449
Prices to be economically cost neutral	449
Top-up trading prices may include 3% margin.....	450
Trading prices may differ from balancing prices.....	450
Balancing top-up price not to exceed balancing spill price	450
Residual imbalance tariffs	450
Pricing period and pricing review	450
Administration Fee	451
Audit procedures	452

Appendix 8: Chapter 6 - Compliance	452
Default	452
Payment default	452
Effect of payment default notice	453
General default	453
Effect of general default notice	453
Written warning for having a residual imbalance	453
Imbalance default	453
Effect of imbalance default notice	454
Default by the <i>market service provider</i>	454
No termination for member's default	454
 Appendix 8: Chapter 7 - Intermittent renewable energy generators	 455
Intermittent renewable generators defined	455
Output for intermittent renewable generators	455
 Appendix 8: Chapter 8 - Dispute resolution	 455
<i>Applicant</i>	455
Disputes	455
Procedure	456
Award by the arbitrator	456
Restrictions on awards.....	456
Effect of awards	456
No third party intervention in arbitration	457
Performance of obligations	457
Commercial Arbitration Act 1985 does not apply	457
Additional jurisdiction of arbitrator for contractual disputes	457
Procedural rules for contractual disputes.....	457
 Appendix 8: Chapter 9 - Other provisions	 457
Provisions of access contract apply	457
Publishing information	458
Title to electricity	458
 Appendix 8: Chapter 10 - Operating procedures	 458
Members must comply with operating procedures	458
 Appendix 8: Chapter 11– TUAS Consultation Group	 458
 Appendix 8: Chapter 12 – Amendment of rules	 459
Transitional amendments.....	459
Submission of request for amendment of the rules	459
Amendment of TUAS market rules	459
Requirements for operating procedures.....	461
 Appendix 8: Appendix 1 – Application form	 462
Date	462
<i>Applicant</i>	462
Contact person.....	462

Access contract	462
Modification of access contract	463
Information regarding security	463
Maximum trading requirements.....	463
Forecast production data.....	463
Signing.....	463
Appendix 8: Appendix 2 – TUAS Audits	464
Audit of the <i>market service provider</i>	464
Auditor’s qualifications etc.....	464
Auditor’s conflict of interest.....	464
Terms of auditor’s retainer	465
Confidentiality	465
The <i>market service provider</i> , members must cooperate with auditor.....	466
Audit report.....	466
Level of Audit	467
Audit report.....	467
Audit summary report.....	467
Appendix 8: Appendix 3 - Modified ETR balancing provisions.....	469
“21. Interpretation of regulations 22, 23 and 25	469
22. Balancing	469
23. Excess standby generation charge	470
24. Excess network usage charge.....	472
Appendix 8: Appendix 4 – Modified EDR balancing provisions.....	476
“23. Interpretation of regulations 24, 25 and 27	476
26. Excess network usage charge.....	480
27. Other consequences of being out of balance.....	482
Appendix 8: Appendix 5 – Operating Procedures	484
Communications	484
Line losses	485
High Price days	485
Liquids Event	485
Calculating band size for top-up trading bands	485
Calculating band size for spill trading bands.....	485
Forecast production data.....	485
Appendix 8: Appendix 6 – Procedural rules for arbitration	487
Application.....	487
Informality and expedition	487
Arbitrator may request information.....	487
Right to representation	488
Procedure.....	488
Determinations	489
Contempt.....	489
Disclosure of information.....	489
Power to take evidence on oath or affirmation.....	489

Failing to attend as a witness	490
Failing to answer questions etc.	490
Intimidation etc.	490
Party may request arbitrator to treat material as confidential.....	491
Appeal to Court.....	492
Copies of decisions to be given to the Minister	492
Effect of appointment of new arbitrator on evidence previously given and awards and determinations previously made.....	492
Arbitrator may issue summons	493
Decision of the Arbitrator.....	494

1. Introduction

The Market Rules

1.1. Authority of Market Rules

1.1.1. These are the market rules made under the Regulations and contemplated by section 123 of the Electricity Industry Act 2004 (“**Electricity Industry Act**”).

Note: due to the scheme of the legislation the rules will have to be consistent with the regulations contemplated by section 122 of the Electricity Industry Act, when made

1.1.2. These Market Rules govern the market and the operation of the South West interconnected system, including the wholesale sale and purchase of electricity, Reserve Capacity, and Ancillary Services.

1.2. Objectives

1.2.1. The objectives of the market are:

- (a) to promote the economically efficient, safe and reliable production and supply of electricity and electricity related services in the South West interconnected system;
- (b) to encourage competition among generators and retailers in the South West interconnected system, including by facilitating efficient entry of new competitors;
- (c) to avoid discrimination in that market against particular energy options and technologies, including sustainable energy options and technologies such as those that make use of renewable resources or that reduce overall greenhouse gas emissions;
- (d) to minimise the long-term cost of electricity supplied to customers from the South West interconnected system; and
- (e) to encourage the taking of measures to manage the amount of electricity used and when it is used.

Conventions

1.3. Electricity Industry Act and Regulations

1.3.1. A word or phrase defined in the Electricity Industry Act or the Regulations has the same meaning when used in these Market Rules.

1.4. Other rules of interpretation

1.4.1. In these Market Rules, unless the contrary intention appears:

Chapter 1

- (a) **(Glossary)**: a word or phrase listed in the Glossary in Chapter 11 has the meaning given in the Glossary;
- (b) **(day)**: a day means a calendar day;
- (c) **(business day)**: a business day means a day that is not a Saturday, Sunday or a public holiday throughout Western Australia;
- (d) **(singular and plural)**: the singular includes the plural and the plural includes the singular;
- (e) **(gender)**: a reference to a gender includes any gender;
- (f) **(headings)**: headings (including those in brackets at the beginning of paragraphs) are for convenience only and do not affect the interpretation of these Market Rules;
- (g) **(persons)**: a reference to a person includes an individual, a firm, a body corporate, a partnership, a joint venture, an unincorporated body or association, or any government agency;
- (h) **(things)**: a reference to any thing (including any amount) is a reference to the whole and each part of it;
- (i) **(clauses etc)**: a reference to a clause, chapter, annexure or schedule is a reference to a clause or chapter in or annexure or schedule to the Market Rules;
- (j) **(statutes etc)**: a reference to a statute, ordinance, code or other law includes regulations and other instruments under it and consolidations, amendments, re-enactments or replacements of any of them;
- (k) **(variations)**: a reference to a document (including the Market Rules) includes any variation or replacement of it;
- (l) **(other parts of speech)**: other parts of speech and grammatical forms of a word or phrase defined in the Glossary in chapter 11 have a corresponding meaning;
- (m) **(appointments)**: where these Market Rules confer a power on a person to make an appointment to a position, the person also has the power:
 - i. to specify the period for which any person appointed in exercise of the power ("**appointee**") holds the position;
 - ii. to remove or suspend an appointee and to reappoint or reinstate an appointee; and
 - iii. where an appointee is suspended or is unable, or expected to become unable, for any other cause to perform the functions of the position, to appoint a person to act temporarily in place of the appointee during the period of suspension or other inability;

- (n) **(amendments)**: if the IMO or System Management has the power to make, prescribe, determine, compile, establish or develop a document, instrument, matter or thing, then the IMO or System Management also has the power to amend, replace or revoke the whole or part of that document, instrument, matter or thing exercisable in like manner and subject to like conditions (if any);
- (o) **(functions)**: “function” includes function, power, duty, responsibility and authority;
- (p) **(include or including)**: the words “include” or “including” are not used as, nor are they to be interpreted as, words of limitation, and, when introducing an example, do not limit the meaning of the words to which the example relates;
- (q) **(Loss Factor adjusted)**: In these Market Rules, “Loss Factor adjusted” in respect of a quantity of electricity means that the quantity must be multiplied by any applicable Loss Factor; and
- (r) **(Headings and comments)**: headings and comments appearing in boxes in these Market Rules (other than the Refund Table in clause 4.26) are for convenience only and do not affect the interpretation of these Market Rules.

1.4.2. In these Market Rules, unless the contrary intention appears, any notice or confirmation required to be issued by the IMO may be issued by an automated software system employed by the IMO.

1.5. Subservient Documents

1.5.1. The following documents are subservient to the rules:

- (a) Market Procedures; and
- (b) any other document or instrument issued, made or given by the IMO under the Market Rules.

Forms required for the submission of information to the IMO and System Management should be part of Market Procedures.
--

1.5.2. In the event of conflict between the Market Rules and other documents, then the order of precedence is to be, in the following order:

- (a) the Electricity Industry Act;
- (b) the Regulations;
- (c) the Market Rules;
- (d) the Market Procedures; and
- (e) any other document or instrument issued, made or given by the IMO under the Market Rules.

Chapter 1

1.5.3. If a provision of a document which is higher in the order of precedence (in this clause called the “higher provision”) is inconsistent with a provision of a document which is lower in the order of precedence, then the higher provision prevails, but only to the extent of the inconsistency.

1.6. Notices

1.6.1. The IMO must develop a Market Procedure which sets out the method by which notices and communications required under, contemplated by or relating to, these Market Rules are to be given to or by the IMO.

1.7. Publication

1.7.1. Where the IMO is required by these Market Rules to publish or release a document or information, then the IMO must make that document or information available on the Market Web Site, in a place which is generally accessible by members of the class of persons entitled to access that document or information given the IMO’s determination of its confidentiality status in accordance with clause 10.2.

Staging

1.8. Staging of the Market Rules

1.8.1. Subject to clause 1.8.2, a provision of the Market Rules commences at the time fixed by the Minister.

1.8.2. Chapter 1, Chapter 4, Chapter 11 and Appendix 8 commence when these Market Rules are made.

1.8.3. The Minister may fix different times for different provisions of these Market Rules under clause 1.8.1.

1.8.4. The Minister must publish notice of the commencement time fixed for a provision under clause 1.8.1 in the Government Gazette.

1.8.5. Until such time as clauses 2.4 to 2.11 take effect, the Minister may develop, maintain and make Amending Rules, and develop, formulate and publish Market Procedures in accordance with the Regulations.

1.8.6. To avoid doubt, and without limiting the foregoing, where a word or phrase listed in the Glossary in Chapter 11 is defined by reference to a provision of these Market Rules, regard should be had to that provision for the purposes of determining the meaning of that word or phrase, even though the provision has not yet commenced.

<p>The following table is intended to provide a very provisional non-binding indication as to when rules might be brought into effect. The table only considers second level headings, whereas some lower level clauses may have further timing restrictions placed on them.</p>
--

Chapter 1

This table is provided only for ease of reference and does not affect the time from which a provision of the Market Rules becomes effective in accordance with clause 1.8.

Chapter	Date	Clause
1 - Introduction	5 Oct 2004	Entire Chapter
2 - Administration	4 Jan 2005	2.1, 2.2, 2.12 2.17 to 2.23 2.28 to 2.34
	1 Jul 2006	Entire Chapter
3 - Power System Security and Reliability	1 Jul 2006	Entire Chapter
4 - Reserve Capacity Rules	5 Oct 2004	Entire Chapter
5 - Network Control Service Procurement	1 Jul 2006	Entire Chapter
6 - The Energy Market	1 Jul 2006	Entire Chapter
7 - Dispatch	1 Jul 2006	Entire Chapter
8 - Wholesale Market Metering	1 Jul 2006	Entire Chapter
9 - Settlement	1 Jul 2006	Entire Chapter
10- Release of Market Information	4 Jan 2005	Parts of Chapter
	1 Jul 2006	Entire Chapter
11 - Glossary	5 Oct 2004	Entire Chapter

1.9. Transition

1.9.1. The Minister may perform any of the functions of the IMO under, or obligations imposed on the IMO by, clauses 4.2, 4.3 and 4.4 in respect of the first Reserve Capacity Cycle.

1.9.2. Until the IMO is established, the Minister may perform any of the other functions of the IMO under, or obligations imposed on the IMO by, these Market Rules in accordance with the Regulations.

1.9.3. Where the IMO or the Minister:

- (a) takes any action to enable the IMO to perform functions under, or obligations imposed by, a provision of these Market Rules, before the provision commences in anticipation of the provision commencing; and
- (b) the action was taken so far as reasonably practicable in accordance with the provision, as though the provision was in force at the time the action was taken,

then, after the provision commences, the action is deemed to have been taken validly in accordance with the provision.

1.9.4. Any action taken by the Minister under clause 1.9.1 or 1.9.2 is deemed to have been taken by the IMO for the purposes of these Market Rules.

Chapter 1

- 1.9.5. In making any determination or decision or taking any action under these Market Rules, the IMO may rely on any action by the IMO or the Minister under clause 1.9.1 or 1.9.2.
- 1.9.6. The IMO may treat any expression of interest, submission, application, approval, statement or document (“**the application**”) made or given by a person to the IMO or the Minister in anticipation of a provision of these Market Rules commencing as having been made to the IMO after the relevant provision commences and the IMO may take action under these Market Rules on the basis of the application or taking into account the application.
- 1.9.7. For the purposes of Regulation 4(3), Appendix 8 of these Market Rules has effect instead of the top-up and spill rules.
- 1.9.8. Where a word or a phrase is defined in Appendix 8 that word or phrase is defined for the purposes of Appendix 8 only.
- 1.9.9. Where in Appendix 8 there is a reference to a rule, a clause, a chapter or an appendix those references are confined to Appendix 8 only.
- 1.9.10. Appendix 8 ceases to have effect at Energy Market Commencement.
- 1.9.11. The following provisions relate to Outage Scheduling and are to cease to have effect following Energy Market Commencement:
- (a) This clause 1.9.11 is applicable to a Rule Participant’s transmission networks and generation systems to which that Rule Participant anticipates clause 3.18.2(c) will apply upon registration of the facility or, in the case of a generation system, upon the registration of an Intermittent Load to be supplied by that facility.
 - (b) A Rule Participant owning or operating a facility to which (a) relates may submit Outage Plans for such facility with System Management in accordance with the Power System Operation Procedure as if clause 3.18.2(c) relates to the facility.
 - (c) Where a Rule Participant submits an Outage Plan for a facility to System Management in accordance with (b) and System Management is of a view that after Energy Market Commencement the list described in clause 3.18.2(c) would be applicable to the facility then System Management must process the Outage Plan in accordance with the Power System Operation Procedure as if clause 3.18.2(c) relates to the facility.
 - (d) Where System Management has approved an Outage Plan for a facility in accordance with (c) then that Outage Plan is to continue to apply to that facility after it becomes a Registered Facility or, in the case of a generation system, upon registration of an Intermittent Load to be supplied by that facility.

Chapter 1

- (e) Any Outage Plan approved in accordance with this clause 1.9.11 for a facility is deemed to have been scheduled and approved in accordance with Chapter 3 once that facility becomes a Registered Facility or a generation system serving an Intermittent Load.

1.9.12. Until three months after Energy Market Commencement the IMO or System Management (as applicable) need take no action under clause 2.13 in respect of suspected non-compliance by a Rule Participant where, in the view of the IMO or System Management (as applicable), it would not be reasonable to expect the Rule Participant to comply fully with the Market Rules because of restrictions in the timing of events and the availability of data or system limitations where these restrictions or limitations stem from the commissioning of the energy market, provided that the Rule Participant employs reasonable endeavours to comply with the intent of the Market Rules.

2. Administration

Functions and Governance

2.1. Independent Market Operator

2.1.1. The Independent Market Operator, or IMO, is established under the Electricity Industry (Independent Market Operator) Regulations 2004.

2.1.2. The functions of the IMO are:

- (a) to administer these Market Rules;
- (b) to operate the Reserve Capacity mechanism, the Short Term Energy Market and the balancing process;
- (c) to settle such transactions as it is required to under these Market Rules;
- (d) to carry out a Long Term PASA study and to publish the Statement of Opportunities Report;
- (e) to administer tender processes for Network Control Services where required by these Market Rules and to enter into Network Control Service Contracts;
- (f) to process applications for participation, and for the registration, de-registration and transfer of facilities;
- (g) to release information required to be released by these Market Rules;
- (h) to publish information required to be published by these Market Rules;
- (i) to develop amendments to these Market Rules and replacements for them;
- (j) to develop Market Procedures, and amendments and replacements for them, where required by these Market Rules;
- (k) to make available copies of the Market Rules and Market Procedures, as are in force at the relevant time;
- (l) to monitor other Rule Participants' compliance with the Market Rules, to investigate potential breaches of the Market Rules, and if thought appropriate, initiate enforcement action under the Regulations and these Market Rules;
- (m) to support the Economic Regulation Authority in its market surveillance role, including providing any market related information required by the Economic Regulation Authority;
- (n) to support the Economic Regulation Authority in its role of monitoring market effectiveness, including providing any market related information required by the Economic Regulation Authority; and
- (o) to carry out any other functions conferred, and perform any obligations imposed, on it under these Market Rules.

Chapter 2

2.1.3. The IM3O may delegate any of its functions under the Market Rules (other than the power to do the things indicated as not able to be delegated in regulation 17(l) of the Regulations) to a person or body of persons that is, in the IMO's opinion, competent to exercise the relevant functions. A function performed by a delegate is to be taken to be performed by the IMO. A delegate performing a function under this clause 2.1.3 is to be taken to do so in accordance with the terms of the delegation unless the contrary is shown.

2.2. System Management

2.2.1. **The Electricity Networks Corporation**, acting through the segregated business unit known as System Management, has the function of operating the SWIS in a secure and reliable manner for the purposes of regulation 13(1) of the Regulations.

2.2.2. The other functions of System Management in relation to the Wholesale Energy Market are:

- (a) to procure adequate Ancillary Services where **the Electricity Generation Corporation** cannot meet the Ancillary Service Requirements;
- (b) to assist the IMO in the processing of applications for participation and for the registration, de-registration and transfer of facilities;
- (c) to develop Market Procedures, and amendments and replacements for them, where required by these Market Rules;
- (d) to release information required to be released by these Market Rules;
- (e) to monitor Rule Participants' compliance with Market Rules relating to dispatch and Power System Security and Power System Reliability; and
- (f) to carry out any other functions or responsibilities conferred, and perform any obligations imposed, on it under these Market Rules.

2.2.3. System Management may delegate any of its functions under the Market Rules (other than the power to do the things indicated as not able to be delegated in the Regulations) to a person or body of persons that is, in System Management's opinion, competent to exercise the relevant functions. A function performed by a delegate is to be taken to be performed by System Management. A delegate performing a function under this clause 2.2.3. is to be taken to do so in accordance with the terms of the delegation unless the contrary is shown.

System Management will be a ring-fenced business unit of **the Electricity Networks Corporation** and will report to the **Electricity Networks Corporation** Board with regard to performance against budgets and objectives, including its compliance with the Market Rules. The Board will in turn report to the Shareholding Minister. System Management's compliance with the rules will be monitored by the IMO and breaches reported to the ERB, and the IMO will report on System Management's performance to the Minister.

Chapter 2

2.3. The Market Advisory Committee

2.3.1. The Market Advisory Committee is a committee of industry representatives convened by the IMO:

- (a) to advise the IMO regarding Rule Change Proposals;
- (b) to advise the IMO and System Management regarding Procedure Change Proposals; and
- (c) to advise the IMO regarding market operation and SWIS operation matters.

Note that the MAC does not vote on issues – instead it is a forum for views to be heard and advice to be offered to the IMO on rule and procedure changes and more generally on the operation of the market.

2.3.2. The IMO must develop and publish a constitution for the Market Advisory Committee detailing:

- (a) the process for convening the Market Advisory Committee;
- (b) the terms of reference of the Market Advisory Committee;
- (c) the membership terms of Market Advisory Committee members;
- (d) the process for appointing and replacing Market Advisory Committee members by the IMO;
- (e) the conduct of Market Advisory Committee meetings;
- (f) the role of the Market Advisory Committee secretariat; and
- (g) interaction between the Market Advisory Committee and the IMO.

2.3.3. The constitution of the Market Advisory Committee must be consistent with the Market Rules.

2.3.4. The IMO must invite public submissions when developing or amending the constitution of the Market Advisory Committee.

2.3.5. Subject to clause 2.3.13., the Market Advisory Committee must comprise:

- (a) three members representing generators, of whom one must represent the Electricity Generation Corporation;
- (b) one member representing Contestable Customers;
- (c) at least one and not more than two members representing Network Operators, of whom one must represent the Electricity Networks Corporation;
- (d) three members representing retailers, of whom one must represent the Electricity Retail Corporation;
- (e) one member nominated by the Minister to represent small consumers;

Chapter 2

- (f) one member representing System Management;
 - (g) one member representing the IMO; and
 - (h) a chairperson of the Market Advisory Committee, who must be a representative of the IMO.
- 2.3.6. The Minister may appoint a representative to attend Market Advisory Committee meetings as an observer.
- 2.3.7. The Economic Regulation Authority may appoint a representative to attend Market Advisory Committee meetings as an observer.
- 2.3.8. The IMO may appoint and remove members of the Market Advisory Committee.
- 2.3.9. The IMO must annually review the composition of the Market Advisory Committee and may remove and appoint members following the review.
- 2.3.10. When appointing and removing members of the Market Advisory Committee, the IMO must consult with, and take nominations from, industry groups that it considers relevant to the wholesale electricity market, and, if practicable, must choose members from persons nominated.
- 2.3.11. The IMO may remove a member of the Market Advisory Committee at any time in the following circumstances:
- (a) the person becomes an undischarged bankrupt;
 - (b) the person becomes of unsound mind or his or her estate is liable to be dealt with in any way under law relating to mental health; or
 - (c) an event specified for this purpose in the constitution for the Market Advisory Committee occurs; or
 - (d) in the IMO's opinion the person no longer represents the person or class of persons that they were appointed to represent in accordance with clause 2.3.5.
- 2.3.12. A member of the Market Advisory Committee may resign by giving notice to the IMO in writing.
- 2.3.13. Where a position on the Market Advisory Committee is vacant at any time, the IMO must make reasonable endeavours to appoint a person to fill the position, but the Market Advisory Committee may continue to perform its functions under this clause 2.3 despite any vacancy.
- 2.3.14. The IMO must provide a secretariat for the Market Advisory Committee. The secretariat must:
- (a) schedule meetings and maintain the diary of the Market Advisory Committee; and

Chapter 2

- (b) prepare and publish the minutes of each meeting of the Market Advisory Committee.

2.3.15. The secretariat must convene the Market Advisory Committee:

- (a) on any occasion where these Market Rules require a meeting to discuss a Rule Change Proposal or Procedure Change Proposal;
- (b) not less than once every six months so as to raise and discuss issues with respect to the operation of the market; and
- (c) on any occasion when two or more members of the Market Advisory Committee have informed the secretariat in writing that they wish to bring a matter regarding market operation or the operation of these Market Rules before the Market Advisory Committee for discussion.

2.3.16. Subject to clause 10.2.4, the IMO must provide the members of the Market Advisory Committee any information in its possession that is pertinent to the issues being addressed by the Market Advisory Committee.

2.3.17. The Market Advisory Committee may nominate a Working Group comprised of Representatives of Rule Participants to assist the Market Advisory Committee in advising the IMO.

Market Documents

2.4. Market Rules

2.4.1. The IMO:

- (a) is responsible for maintaining the Market Rules; and
- (b) is responsible for ensuring the development of amendments of, and replacements for, the Market Rules; and
- (c) may make amending rules (as defined in the Regulations) ("**Amending Rules**") in accordance with this Chapter.

2.4.2. The IMO must not make Amending Rules unless it is satisfied that the Market Rules, as proposed to be amended or replaced, are consistent with the Wholesale Market Objectives.

2.4.3. In deciding whether or not to make Amending Rules, the IMO must have regard to the following:

- (a) any applicable policy direction given to the IMO under clause 2.5.2;
- (b) the practicality and cost of implementing the Rule Change Proposal;
- (c) the views expressed in any submissions on the Rule Change Proposal;

Chapter 2

- (d) the views expressed by the Market Advisory Committee where the Market Advisory Committee met to consider the Rule Change Proposal; and
- (e) any technical studies that the IMO considers are necessary to assist in assessing the Rule Change Proposal.

2.4.4. The IMO must maintain on the Market Web Site a Rules Change Proposal form which must include:

- (a) contact details for proposing rule changes; and
- (b) information that must be provided in proposing a change, including:
 - i. the name of the person submitting the Rule Change Proposal, and where relevant, details of the organisation that person represents;
 - ii. the issue to be addressed;
 - iii. the degree of urgency of the proposed change;
 - iv. any proposed specific changes to particular rules;
 - v. a description of how the rule change would allow the Market Rules to better address the Wholesale Market Objectives; and
 - vi. any identifiable costs and benefits of the change.

2.5. Rule Change Proposals

2.5.1. Any person (including the IMO) may make a Rule Change Proposal by completing a Rule Change Proposal form. A person other than the IMO must submit the completed Rule Change Proposal form to the IMO.

This includes Rule Participants, the IMO, System Management, the public etc

2.5.2. The Minister may give a policy direction to the IMO with respect to the development of the market. A policy direction must not be inconsistent with the Wholesale Market Objectives. Before giving a policy direction, the Minister may provide a draft of the proposed policy direction to the IMO and seek the IMO's views on it.

2.5.3. If the Minister gives a policy direction, the IMO must develop one or more Rule Change Proposals implementing the policy direction and progress it using the rule change process in this clause 2.5 and clauses 2.6 to 2.8.

2.5.4. Where the IMO considers that a change to the Market Rules is required to maintain consistency with any applicable law or regulation or the Wholesale Market Objectives, the IMO is responsible for developing an appropriate Rule Change Proposal.

Chapter 2

- 2.5.5. Where necessary, the IMO may contact the person submitting a Rule Change Proposal and request clarification of any aspect of the Rule Change Proposal. Any clarification received is to be deemed to be part of the Rule Change Proposal.
- 2.5.6. Within five Business Days of the later of:
- (a) receiving the Rule Change Proposal; and
 - (b) any clarification under clause 2.5.5,
- the IMO must notify the person who submitted the Rule Change Proposal whether or not the IMO will progress the Rule Change Proposal any further.
- 2.5.7. When it has developed a Rule Change Proposal, or within seven Business Days of receiving a Rule Change Proposal under clause 2.5.1, the IMO must publish notice of the Rule Change Proposal on the Market Website. The notice must include:
- (a) the date that the Rule Change Proposal was submitted, if applicable;
 - (b) the name, and where relevant, the organisation, of the person who made the Rule Change Proposal;
 - (c) details of the Rule Change Proposal, including relevant references to clauses of the Market Rules and any proposed specific changes to those clauses;
 - (d) the description of how the rule change would allow the Market Rules to better address the Wholesale Market Objectives given by the person submitting the proposed rule change;
 - (e) whether the Rule Change Proposal will be progressed and the reason why the Rule Change Proposal will or will not be progressed; and
 - (f) if the Rule Change Proposal will be progressed further:
 - i. whether the Rule Change Proposal is to be subject to the Fast Track Rule Change Process in accordance with clause 2.5.9 and the reasons for this decision;
 - ii. if the Rule Change Proposal is subject to the Fast Track Rule Change process, and the Rule Change Proposal did not include proposed specific changes to clauses, the IMO's proposed Amending Rules to implement the Rule Change Proposal; and
 - iii. if the Rule Change is not subject to the Fast Track Rule Change process, a call for submissions in relation to the Rule Change Proposal. The due date for submissions must be:
 - 1. six weeks after the notification or, if that day is not a Business Day, then the next Business Day following that six week period; or
 - 2. if a longer timeframe is determined in accordance with clause 2.5.10, at a time that is consistent with that timeframe.

Chapter 2

- 2.5.8. Where a Rule Change Proposal that will be progressed relates to a Protected Provision the IMO must notify the Minister at the same time as it gives the notice described in clause 2.5.7.
- 2.5.9. The IMO may subject a Rule Change Proposal to the Fast Track Rule Change Process if, in its opinion, the Rule Change Proposal:
- (a) is of a minor or procedural nature; or
 - (b) is required to correct a manifest error; or
 - (c) is urgently required and is essential for the safe, effective and reliable operation of the market or the SWIS.
- 2.5.10. Subject to clause 2.5.12, the IMO may at any time after deciding to progress a Rule Change Proposal decide to extend the normal timeframe for processing Rule Change Proposals. If the IMO decides to do so, then it may modify the times and time periods under clauses 2.6 or 2.7 in respect of the Rule Change Proposal and publish details of the modified times and time periods.
- 2.5.11. If a Rule Change Proposal was subject to the Fast Track Rule Change Process, and the IMO decides to extend the timeframe, it must either:
- (a) extend the timeframe by no more than 15 Business Days; or
 - (b) reclassify the Rule Change Proposal as not being subject to the Fast Track Rule Change Process, and must progress it in accordance with clause 2.7.
- 2.5.12. The IMO must publish a notice of an extension determined in accordance with clause 2.5.10, and must update any information already published in accordance with clause 2.5.7(f).
- 2.5.13. A notice of extension must include:
- (a) the reasons for the proposed extension;
 - (b) the views of any Rule Participants consulted on the extension;
 - (c) the proposed length of any extension; and
 - (d) the proposed work program.
- 2.5.14. A Rule Change Proposal that the IMO decides is subject to the Fast Track Rule Change Process is to be progressed in accordance with clause 2.6 and clause 2.7 does not apply.
- 2.5.15. A Rule Change Proposal that the IMO decides is not subject to the Fast Track Rule Change Process is to be progressed in accordance with clause 2.7 and clause 2.6 does not apply.

Chapter 2

2.6. Fast Track Rule Change Process

2.6.1. Within five Business Days of publishing the notice referred to in clause 2.5.7, the IMO must notify those Rule Participants that it considers have an interest in the Rule Change Proposal of its intention to consult with them concerning the Rule Change Proposal.

Note that the IMO has already published notice of the Rule Change Proposal in accordance with clause 2.5.7, so participants other than those notified by the IMO under clause 2.6.1 can also request that the IMO consult with them via clause 2.6.2.

2.6.2. Within five Business Days of publishing the notice referred to in clause 2.5.7, a Rule Participant may notify the IMO that they wish to be consulted concerning the Rule Change Proposal.

2.6.3. Within 15 Business Days of publishing the notice referred to in clause 2.5.7, the IMO must have completed such consultation as the IMO considers appropriate in the circumstances with the Rule Participants described in clauses 2.6.1 and 2.6.2.

2.6.4. Within 20 Business Days of publishing the notice referred to in clause 2.5.7, the IMO must prepare and publish a Final Rule Change Report containing:

- (a) the information in the notice of the Rule Change Proposal under clause 2.5.7;
- (b) any analysis of the Rule Change Proposal that the IMO has carried out;
- (c) the identities of Rule Participants that were consulted;
- (d) information on any objections expressed by the Rule Participants consulted, and the IMO's response to the objections;
- (e) the IMO's assessment of the Rule Change Proposal in light of clauses 2.4.2 and 2.4.3;
- (f) a decision by the IMO that:
 - i. the Rule Change Proposal be accepted in the proposed form; or
 - ii. the Rule Change Proposal be accepted in a modified form; or
 - iii. the Rule Change Proposal be rejected;
- (g) the IMO's reasons for the decision; and
- (h) if the IMO decides to make Amending Rules arising from the Rule Change Proposal:
 - i. the wording of the Amending Rules; and
 - ii. the proposed date and time that the Amending Rules will commence.

Chapter 2

2.7. Standard Rule Change Process

- 2.7.1. Any person may make a submission to the IMO relating to a Rule Change Proposal within the time frame specified under clause 2.5.7(f)(iii).
- 2.7.2. Subject to clause 10.2.4, the IMO must release all information submitted under clause 2.7.1 to the public.
- 2.7.3. The IMO may hold public forums or workshops concerning a Rule Change Proposal.
- 2.7.4. Within one Business Day after the publication of a notice of a Rule Change Proposal in accordance with clause 2.5.7, the IMO must notify the members of the Market Advisory Committee as to whether the IMO considers the Rules Change Proposal to be significant enough to require convening a meeting of the Market Advisory Committee.
- 2.7.5. The IMO must convene a meeting of the Market Advisory Committee concerning a Rules Change Proposal before the due date for submissions in relation to the Rule Change Proposal if:
- (a) the IMO considers the Rule Change Proposal to be significant; or
 - (b) two or more members of the Market Advisory Committee have informed the IMO in writing that they consider that the Rule Change Proposal is significant.
- 2.7.6. Within 20 Business Days following the close of submissions, the IMO must:
- (a) prepare and publish a draft Rule Change Report on the Rule Change Proposal; and
 - (b) publish a deadline for further submissions in relation to the Rule Change Proposal, where that deadline must be at least 20 Business Days after the date the deadline is published.
- 2.7.7. The draft Rule Change Report must contain:
- (a) the information in the notice of the Rule Change Proposal under clause 2.5.7;
 - (b) all submissions received before the due date for submissions, a summary of those submissions, and the IMO's response to issues raised in those submissions;
 - (c) a summary of any public forums or workshops held;
 - (d) a summary of the views expressed by the members of the Market Advisory Committee where the Market Advisory Committee met to consider the Rule Change Proposal;
 - (e) the IMO's assessment of the Rule Change Proposal in light of clauses 2.4.2 and 2.4.3;

- (f) a proposal as to whether the Rule Change Proposal should be accepted in the form proposed. The proposal may be that:
 - i. the Rule Change Proposal be accepted in the proposed form; or
 - ii. the Rule Change Proposal be accepted in a modified form; or
 - iii. the Rule Change Proposal be rejected; and
- (g) if the IMO proposes to make Amending Rules arising from the Rule Change Proposal:
 - i. the wording of the proposed Amending Rules; and
 - ii. a proposed date and time the proposed Amending Rules will commence.

2.7.8. Within 20 Business Days of the deadline specified under clause 2.7.6(b), the IMO must prepare and publish a Final Rule Change Report containing:

- (a) the information in the Draft Rule Change Report;
- (b) all submissions received before the deadline for submissions specified in relation to the relevant draft Rule Change Report under clause 2.7.6(b), a summary of those submissions, and the IMO's response to the issues raised in those submissions;
- (c) any further analysis or modification to the Rules Change Proposal;
- (d) the IMO's assessment of the Rule Change Proposal in light of clauses 2.4.2 and 2.4.3;
- (e) a decision by the IMO that:
 - i. the Rule Change Proposal be accepted in the proposed form; or
 - ii. the Rule Change Proposal be accepted in a modified form; or
 - iii. the Rule Change Proposal be rejected;
- (f) the IMO's reasons for the decision; and
- (g) if the IMO decides to make Amending Rules arising from the Rule Change Proposal:
 - i. the wording of the Amending Rules; and
 - ii. the proposed date and time that the Amending Rules will commence.

2.8. Review of IMO Rule Amendment Decisions, Ministerial Approval and Coming into Force of Rule Amendments

<p>It is proposed that Regulations will be made to give the Energy Review Board the powers contemplated by this clause. This clause will reflect those regulations when made.</p>

Chapter 2

- 2.8.1. A Rule Participant may apply to the Energy Review Board for a Procedural Review of a decision by the IMO contemplated by clause 2.5.9, 2.6.4(f) or 2.7.8(e) within 10 Business Days of the relevant decision, on the grounds that the IMO has not followed the rule change process set out in clauses 2.5, 2.6 and 2.7.
- 2.8.2. Following an application for a Procedural Review under clause 2.8.1, if the Energy Review Board finds that the IMO has not followed the rule change process set out in clauses 2.5, 2.6 and 2.7 the Energy Review Board may set aside the IMO's decision and direct the IMO to reconsider the relevant Code Change Proposal in accordance with the process set out in clauses 2.5, 2.6 and 2.7.
- 2.8.3. The IMO must submit a Rule Change Proposal, together with the Final Rule Change Report, to the Minister for approval where Amending Rules in the Final Rule Change Report under clause 2.6.4 or 2.7.8 amend or replace a Protected Provision, or, in the IMO's opinion, would have the effect of changing the meaning or effect of one or more Protected Provisions.
- 2.8.4. Subject to clause 2.8.6, the Minister must consider the Rule Change Proposal within 20 Business Days and decide whether the Market Rules, as amended or replaced by the proposed Amending Rules, are consistent with the Wholesale Market Objectives.
- 2.8.5. Where a Rule Change Proposal is submitted under clause 2.8.3, the Minister may:
- (a) approve the proposed Amending Rules;
 - (b) not approve the proposed Amending Rules; or
 - (c) send back to the IMO the proposed Amending Rules with any revisions the Minister considers are required to ensure the Market Rules, as amended or replaced by the proposed Amending Rules, are consistent with the Wholesale Market Objectives.
- 2.8.6. The Minister may extend the time for a decision on a Rule Change Proposal under clause 2.8.4 by a further period of up to 20 Business Days by notice to the IMO. The Minister may extend the time for a decision in respect of a Rule Change Proposal more than once.
- 2.8.7. The IMO must publish notice of any extension under clause 2.8.6 on the Market Web Site.
- 2.8.8. Where the Minister does not make a decision by the original date determined in accordance with clause 2.8.4, or by an extended date determined in accordance with clause 2.8.6, as applicable, then the proposed Amending Rules will be taken to have been approved by the Minister.

This default clause means that the Minister must take explicit action to prevent the rule change.

Chapter 2

2.8.9. Where the Minister does not approve the proposed Amending Rules or sends proposed Amending Rules back to the IMO under clause 2.8.5(c), the Minister must give reasons, and the IMO must publish notice of the Minister's decision and the reasons given by the Minister

2.8.10. Where the Minister sends proposed Amending Rules back to the IMO in accordance with clause 2.8.5(c), the IMO must:

- (a) publish the revised Amending Rules and call for submissions on the revised Amending Rules within 15 Business Days of publication; and
- (b) provide a revised Final Rule Change Report, including any submissions received on the Minister's revised Amending Rules to the Minister within 25 Business Days and clauses 2.8.4 to this clause 2.8.10 apply to the revised Final Rule Change Report.

2.8.11. Amending Rules are made:

- (a) For Rule Change Proposals to which clause 2.8.3 applies, when the Minister has either approved, or is taken by clause 2.8.8 to have approved, the Amending Rules; and
- (b) For Rule Change Proposals to which clause 2.8.3 does not apply, when the IMO has decided to make the Amending Rules in accordance with clause 2.6.4(h) or clause 2.7.8(g).

2.8.12. Subject to clause 2.8.2, Amending Rules commence at the time and date determined by the IMO. The IMO must publish notice of the time and date Amending Rules commence.

2.8.13. The following clauses are Protected Provisions:

Please note that cross references have not been checked and must be checked before publication of the Rules.

- (a) clauses 1.1 to 1.3 and 1.5 to 1.9 ;
- (b) clauses 2.1 to 2.24, 2.28, 2.31.1, 2.31.3, 2.31.5(a), 2.31.6, 2.34.1 and 2.36.1;
- (c) clauses 3.15, 3.18.18 and 3.18.19;
- (d) clauses 4.1.4 to 4.1.12, 4.1.15 to 4.1.19, 4.1.21, 4.1.22, 4.1.24, 4.1.27, 4.5.10, 4.5.11, 4.5.15 to 4.5.20, 4.13.10, 4.13.11, 4.16, 4.24.1, 4.24.2 and 4.24.12;
- (e) clauses 5.2.3, 5.2.7 and 5.5.1;
- (f) clauses 9.16.3, 9.16.4 and 9.20.2; and
- (g) clauses 10.1.1, 10.1.2, 10.2.1, 10.3 and 10.4.

Chapter 2

2.9. Market Procedures

- 2.9.1. The IMO must manage the development of, amendment of, and replacement for Market Procedures which these Market Rules require be developed by the IMO.
- 2.9.2. System Management must manage the development of, amendment of, and replacement for Market Procedures which these Market Rules require be developed by System Management.
- 2.9.3. Market Procedures
- (a) must:
 - i. be developed, amended or replaced in accordance with the process in these Market Rules;
 - ii. be consistent with the Wholesale Market Objectives; and
 - iii. be consistent with these Market Rules, the Electricity Industry Act and Regulations; and
 - (b) may be amended or replaced in accordance with clause 2.10 and must be amended or replaced in accordance with clause 2.10 where a change is required to maintain consistency with Amending Rules.
- 2.9.4. The IMO must maintain on the Market Web Site a Procedure Change Submission form.
- 2.9.5. The IMO must develop an Administration Procedure setting out the procedure for developing and amending Market Procedures and:
- (a) the IMO must follow the Administration Procedure when developing and approving Procedure Change Proposals, except when producing the first version of the Administration Procedure;
- The exception for the Administration Procedure is required as it contains the procedure change process itself.
- (b) System Management must follow the Administration Procedure when developing Procedure Change Proposals; and
 - (c) Rule Participants involved in the Procedure Change process must follow the Administration Procedure when assisting the IMO or System Management to develop Procedure Change Proposals.
- 2.9.6. The IMO must comply with Market Procedures applicable to it.
- 2.9.7. System Management must comply with Market Procedures applicable to it.
- 2.9.8. A Rule Participant other than the IMO or System Management must comply with Market Procedures applicable to it.

Chapter 2

2.10. Procedure Change Process

- 2.10.1. The IMO or System Management, as applicable, may initiate the Procedure Change Process by developing a Procedure Change Proposal.
- 2.10.2. Rule Participants may notify the IMO or System Management, as applicable, where they consider an amendment or replacement of a Market Procedure would be appropriate.
- 2.10.3. If an Amending Rule requires the IMO or System Management to develop new Market Procedures or to amend or replace existing Market Procedures, then the IMO or System Management, as applicable, is responsible for the development of, amendment of or replacement for, Market Procedures so as to comply with the Amending Rule.
- 2.10.4. Where the Procedure Change Proposal is developed by System Management, System Management must provide the Procedure Change Proposal to the IMO, and the IMO must publish it.
- 2.10.5. The IMO must publish Procedure Change Proposals that the IMO develops.
- 2.10.6. A Procedure Change Proposal must include:
- (a) a proposed Market Procedure or an amendment of or replacement for a Market Procedure, indicating the proposed amended words, or a proposed Market Procedure; and
 - (b) the reason for the proposed Market Procedure or an amendment of or replacement for a Market Procedure or proposed Market Procedure.
- 2.10.7. At the same time as it publishes a Procedure Change Proposal notice, the IMO must publish a call for submissions on that proposal. The due date for submissions must be 20 Business Days from the date the call for submissions is published., Any person may make a submission using a Procedure Change Submission form.
- 2.10.8. Within one Business Day after the publication of a Procedure Change Proposal notice in accordance with clause 2.10.4 or 2.10.5, as applicable, the IMO must notify all members of the Market Advisory Committee as to whether the IMO considers the Procedure Change Proposal to be significant enough to require convening the Market Advisory Committee.
- 2.10.9. The IMO must convene a meeting of the Market Advisory Committee concerning the Procedure Change Proposal before the due date for submissions in relation to the Procedure Change Proposal if:
- (a) the IMO considers the procedure change to be significant; or

Chapter 2

- (b) two or more members of the Market Advisory Committee have informed the IMO in writing that they consider that the Procedure Change Proposal is significant.
- 2.10.10. Following the closing date for submissions, the IMO or System Management, as applicable, must prepare a Procedure Change Report on the Procedure Change Proposal.
- 2.10.11. Where the Procedure Change Report is prepared by System Management, System Management must provide the Procedure Change Report to the IMO, and the IMO must publish it.
- 2.10.12. The IMO must publish Procedure Change Reports that the IMO prepares.
- 2.10.13. The Procedure Change Report must contain:
- (a) the wording of the proposed Market Procedure or amendment of or replacement for the Market Procedure;
 - (b) the reason for the proposed Market Procedure or amendment of or replacement for the Market Procedure;
 - (c) all submissions received before the due date for submissions, a summary of those submissions, and the response of the IMO or System Management, as applicable, to the issues raised in those submissions;
 - (d) a summary of the views expressed by the Market Advisory Committee;
 - (e) in the case of a Procedure Change Proposal developed by the IMO, a proposed date and time for the Market Procedure or amendment or replacement to commence, which must, in the IMO's opinion, allow sufficient time after the date of publication of the Procedure Change Report for Rule Participants to implement changes required by it; and
 - (f) in the case of a Procedure Change Proposal developed by System Management, a recommendation for a date and time for the Market Procedure, amendment or replacement to commence which, in System Management's opinion, allows sufficient time after the date of publication of the IMO's approval of the Procedure Change Proposal under clause 2.10.12, for Rule Participants to implement changes required by it.
- 2.10.14. For Procedure Change Proposals published by System Management, the IMO must within 10 Business Days of the publication of the Procedure Change Report make a decision as to whether to approve the Procedure Change Proposal. The IMO may:
- (a) approve the Procedure Change Proposal; or
 - (b) reject the Procedure Change Proposal.

Chapter 2

- 2.10.15. Where the IMO approves a Procedure Change Proposal from System Management, it must notify System Management and the IMO must publish, the following information:
- (a) that the Procedure Change Proposal is approved;
 - (b) the IMO's reasons for the decision; and
 - (c) a date and time for the Market Procedure, amendment or replacement to commence, which must, in the IMO's opinion, allow sufficient time after the date of publication of the Procedure Change Report for Rule Participants to implement changes required by it.
- 2.10.16. Where the IMO rejects a Procedure Change Proposal from System Management:
- (a) the IMO must:
 - i. notify System Management; and
 - ii. publish the following information:
 - 1. that the Procedure Change Proposal is rejected; and
 - 2. the IMO's reasons for the decision; and
 - (b) in the case of a Procedure Change Proposal required by an Amending Rule, System Management must submit a revised Procedure Change Proposal in accordance with clause 2.10 that complies with the Amending Rule and is acceptable to the IMO. The provisions of clause 2.10 apply to any revised Procedure Change as if it were a new Procedure Change Proposal by System Management.

Where the Procedure Change Proposal was not required by a Rule Amendment, then System Management has discretion as to whether it wants to revise and resubmit the Procedure Change Proposal or abandon the procedure change.

2.11. Coming into Force of Procedure Amendments

- 2.11.1. A Rule Participant may apply to the Energy Review Board for a Procedural Review of a decision by the IMO or System Management contemplated by clause 2.10.13 or 2.10.14 within 10 Business Days of the decision, on the grounds that the IMO or System Management has not followed the process set out in clause 2.10 or the Administration Procedure.
- 2.11.2. Following an application for a Procedural Review under clause 2.11.1, if the Energy Review Board finds that the IMO or System Management has not followed the process set out in clause 2.10 or the Administration Procedure, the Energy Review Board may set aside the IMO's decision or System Management's decision and direct the IMO or System Management to reconsider the relevant Procedure Change Proposal in accordance with clause 2.10 and the Administration Procedure.

2.11.3. Subject to clauses 2.11.2 and 2.11.4, a Market Procedure or an amendment of or replacement for a Market Procedure commences at the time and date specified under clause 2.10.13(e) or 2.10.15(c), as applicable.

2.11.4. If at any time, the IMO considers that Rule Participants will not have sufficient time to implement any necessary changes required by the Market Procedure, amendment or replacement, the IMO may extend the time and date when that Market Procedure, amendment or replacement commences by publishing notice of the revised time and date when the amendment of or replacement for that Market Procedure commences.

Monitoring, Enforcement and Audit

2.12. Standard of Performance

2.12.1. With the exception of the obligations listed in clause 2.12.2, where the IMO has an obligation under these Market Rules to do something:

- (a) that obligation is limited to a requirement for the IMO to use reasonable endeavours consistent with these Market Rules, including to give such directions or instructions as are within its power, to comply with that obligation; and
- (b) if the IMO fails to do that thing notwithstanding the use of the IMO's reasonable endeavours, the IMO will be taken not to have breached the obligation.

2.12.2. Clause 2.12.1 does not apply to:

- (a) the obligations of the IMO under clauses 2.18 to 2.20;
- (b) the obligations of the IMO in relation to the registration of Rule Participants and Facilities in clauses 2.28 to 2.32;
- (c) subject to clause 9.24, any payment obligations of the IMO under these Market Rules.

2.12.3. With the exception of the obligations listed in clause 2.12.4, where System Management has an obligation under these Market Rules to do something:

- (a) that obligation is limited to a requirement for System Management to use reasonable endeavours consistent with these Market Rules, including to give such directions or instructions as are within its power, to comply with that obligation; and
- (b) if System Management fails to do that thing notwithstanding the use of System Management's reasonable endeavours, System Management will be taken not to have breached the obligation.

2.12.4. Clause 2.12.3 does not apply to the obligations of System Management under clauses 2.18 to 2.20.

Chapter 2

2.12.5. A reference in this clause 2.12 to an obligation to do something includes an obligation to do or not do any act, matter or thing, to achieve any outcome, to maintain any state of affairs or to ensure that any other person does or does not do any act, matter or thing.

2.13. Market Rule Compliance Monitoring and Enforcement

The IMO monitors participants for Rule and Procedure compliance. System Management also monitors participants, but only for compliance with a very restricted set of clauses relating to standing data, system Security and Reliability and dispatch compliance. Participants can also report suspected breaches to the IMO.

The IMO investigates potential breaches, and then, in the case of Category A breaches (less important), makes a decision itself as to whether a breach has occurred, and may impose a penalty up to a maximum set in the regulations. In the case of more serious breaches it investigates and brings the matter to the ERB who make a decision.

Participants may also report alleged IMO rule breaches to the body nominated by the Minister to investigate IMO rule breaches, and that body can refer matters to the ERB for consideration.

- 2.13.1. The Minister may from time to time appoint a person to be responsible for investigating alleged breaches by the IMO of the Market Rules and Market Procedures.
- 2.13.2. The IMO must monitor other Rule Participants' behaviour for compliance with the Market Rules and Market Procedures in accordance with the Monitoring Protocol.
- 2.13.3. The IMO must ensure it has processes and systems in place to allow it to monitor Rule Participants' behaviour for compliance with the Market Rules and Market Procedures in accordance with the Monitoring Protocol.
- 2.13.4. A Rule Participant may inform the IMO in writing if it considers that it or another Rule Participant has breached the Market Rules or a Market Procedure, and may provide evidence of that breach.
- 2.13.5. A Rule Participant may inform the person referred to in clause 2.13.1 in writing if it considers that the IMO has breached the Market Rules or a Market Procedure, and may provide evidence of that breach.
- 2.13.6. System Management must monitor Rule Participants' behaviour for compliance with the provisions of the Market Rules referred to in clause 2.13.9 and Market Procedures developed by System Management. System Management must report any alleged breaches of those provisions or Market Procedures to the IMO, in accordance with the Monitoring and Reporting Protocol.

Chapter 2

2.13.7. System Management must ensure it has processes and systems in place to allow it to monitor Rule Participants' behaviour in accordance with clause 2.13.6.

2.13.8. If System Management becomes aware of an alleged breach of the Market Rules or Market Procedures as a result of its monitoring activities, then it must:

- (a) record the alleged breach of the Market Rules or Market Procedures; and
- (b) notify the IMO of the alleged breach in accordance with clause 2.13.4 or, in the case of an alleged breach by the IMO, notify the person referred to in clause 2.13.1 in accordance with clause 2.13.5.

2.13.9. System Management must monitor Rule Participants for breaches of the following clauses:

- (a) clauses 2.34.2 and 2.34.3;

Ensuring standing data is accurate.

- (b) clauses 3.4.6 and 3.4.8;

Assisting System Management when the power system is in a High-Risk Operating State

- (c) clauses 3.5.8 and 3.5.10;

Assisting System Management when the power system is in an Emergency Operating State

- (d) clauses 3.6.5 and 3.6.6B;

Network Operators implementing under frequency load shedding plans and complying with manual disconnection instructions from System Management

- (e) clauses 3.16.4, 3.16.7, and 3.16.8A;

Rule Participants provide data for MT PASA

- (f) clauses 3.17.5 and 3.17.6;

Rule Participants provide data for ST PASA

- (g) clauses 3.18.2(f);

Rule Participants comply with outage scheduling and approval process

- (gA) clauses 3.21A.2, 3.21A.12, and 3.21A.13;

Rule Participants must seek approval of Commissioning Tests and comply with their approved test plans.

- (h) clause 4.10.2, where System Management is instructed by the IMO under clause 4.25.13;

Chapter 2

Maintaining on-site fuel storage were required by Reserve Capacity obligations

(hA) clause 7.5.5;

Market Participants can only declare a change of fuel in specified situations.

(i) clause 7.7.6(b);

Market Participants acknowledge receipt of Dispatch Instructions.

(j) clauses 7.10.1, 7.10.3, 7.10.6 and 7.10.6A; and

Market Participants follow Resource Plans and Dispatch Instructions.

(k) clause 7.11.7.

Market Participants and Network Operators comply with directions in Dispatch Advisories.

2.13.10. If the IMO becomes aware of an alleged breach of the Market Rules or the Market Procedures, then it must:

- (a) record the alleged breach;
- (b) investigate the alleged breach;
- (c) where it reasonably believes a breach of the Market Rules or Market Procedures has taken place, issue a warning to the Rule Participant to rectify the alleged breach. The warning must:
 - i. identify the clause or clauses of the Market Rules or the Market Procedures that the IMO believes has been, or are being, breached;
 - ii. describe the behaviour that comprises the alleged breach;
 - iii. request an explanation; and
 - iv. request that the alleged breach be rectified and a time (which the IMO considers reasonable) by which the alleged breach should be rectified; and
- (d) record the response of the Rule Participant to the warning.

2.13.11. If the IMO becomes aware of an alleged breach of the Market Rules or the Market Procedures, then it may meet with the relevant Rule Participant on one or more occasions to discuss the alleged breach and possible actions to rectify the alleged breach.

2.13.12. As part of an investigation into alleged breaches of the Market Rules or Market Procedures, the IMO may:

- (a) require information and records from Rule Participants; and
- (b) conduct an inspection of a Rule Participant's equipment.

Chapter 2

2.13.13. Rule Participants must cooperate with an investigation into an alleged breach of the Market Rules or Market Procedures, including:

- (a) providing the IMO with information requested under clause 2.13.12 relating to the alleged breach in a timely manner; and
- (b) allowing reasonable access to equipment for the purpose of an inspection carried on under clause 2.13.12.

2.13.14. Where a Rule Participant does not comply with clause 2.13.13, the IMO may appoint a person to investigate the matter and provide a report or such other documentation as the IMO may require. If the IMO does so, then:

- (a) the Rule Participant must assist the person to undertake the investigation and prepare the report or other documentation; and
- (b) the cost of the investigation and the preparation the report or other documentation must be met by the Rule Participant unless the IMO determines otherwise.

Regulations will be made at a later stage dealing with the enforcement arrangements described in the following clauses.

2.13.15. Where the alleged breach relates to a Category A Market Rule (as determined in accordance with the Regulations) and the IMO is not the Rule Participant that is alleged to have breached the Market Rules, the IMO must make a decision as to whether a breach has occurred.

2.13.16. The IMO may:

- (a) decide a breach has taken place in which case the IMO may issue a penalty notice in accordance with the Regulations; or
- (b) decide a breach has not taken place and notify:
 - i. the Rule Participant that is alleged to have breached the Market Rules; and
 - ii. where a Rule Participant notified the IMO in accordance with clause 2.13.4, that Rule Participant,of its decision.

2.13.17. Where the IMO issues a penalty notice under clause 2.13.16(a), the Rule Participants that received the penalty notice may seek a review of that decision by the Energy Review Board in accordance with the Regulations.

2.13.18. Where:

- (a) the alleged breach relates to a Category B or Category C Market Rule (as determined in accordance with the Regulations); and

Chapter 2

- (b) following the investigation referred to in clause 2.13.10(b), the IMO reasonably believes that a breach of the Market Rules has taken place, the IMO may bring proceedings before the Energy Review Board.
- 2.13.19. Where the person referred to in clause 2.13.1 receives notice of an alleged breach by the IMO in accordance with clause 2.13.5, the person referred to in clause 2.13.1 must investigate the alleged breach of the Market Rules or Market Procedures, and may require information and records from the IMO.
- 2.13.20. The IMO must cooperate with an investigation referred to in clause 2.13.19.
- 2.13.21. Following the investigation referred to in clause 2.13.19, where the person referred to in clause 2.13.1 reasonably believes a breach of the Market Rules or Market Procedures has taken place it:
- (a) may issue a warning to the IMO to rectify the alleged breach. The warning must :
- i. identify the clauses of the Market Rules or the Market Procedures that the person referred to in clause 2.13.1 considers have been breached;
 - ii. describe the behaviour that comprises the alleged breach;
 - iii. request an explanation; and
 - iv. request that the alleged breach be rectified and a time (which the person referred to in clause 2.13.1 considers reasonable) by which the alleged breach should be rectified; and
- (b) may meet with the IMO on one or more occasions to discuss the alleged breach and possible actions to rectify the alleged breach.
- 2.13.22. Where the person referred to in clause 2.13.1 considers that the alleged breach has not been rectified within the time set out in accordance with clause 2.13.21(a)(iv) it may bring proceedings before the Energy Review Board.
- 2.13.23. The orders that the Energy Review Board may make for a breach of the Market Rules and the procedures for the operation of the Energy Review Board are set out in the Regulations.
- 2.13.24. The IMO may direct a Rule Participant to do or to refrain from doing any thing that the IMO thinks necessary or desirable to give effect or to assist in giving effect to any order of the Energy Review Board.
- 2.13.25. A Rule Participant must comply with a direction of the IMO given under clause 2.13.24.
- 2.13.26. The IMO must release a report at least once every six months setting out a summary for the preceding six months of:

Chapter 2

- (a) proceedings that have been brought before the Energy Review Board;
- (b) findings of the Energy Review Board on matters referred to them;
- (c) orders made by the Energy Review Board; and
- (d) civil penalties imposed by the IMO under clause 2.13.16(a), where these have not been set aside by the Energy Review Board.

2.13.27. In considering the circulation of the report under clause 2.13.26 and 2.13.28, the IMO must have regard to the Wholesale Market Objectives.

2.13.28. In addition to the regular publication described in clause 2.13.26, the IMO may release a report on any one or more matters where the IMO has made a decision under clause 2.13.16(a) or which have been referred to the Energy Review Board, the findings of the IMO and the Energy Review Board, as applicable, on those matters and any sanctions imposed by the IMO or the Energy Review Board in relation to those matters.

2.13.29. No Rule Participant or former Rule Participant is entitled to make any claim against the IMO for any loss or damage incurred by the Rule Participant from the publication of any information pursuant to clauses 2.13.26 or 2.13.28 if the publication was done in good faith. No action or other proceeding will be maintainable by the person or Rule Participant referred to in the publication on behalf of the IMO or any person publishing or circulating the publication on behalf of the IMO and this clause operates as leave for any such publication except where the publication is not done in good faith.

2.13.30. Claims for confidentiality of information which may be published under clauses 2.13.26 or 2.13.28 must be dealt with in accordance with the provisions for reporting information in clause 10.2.

2.13.31. The IMO must, and is entitled to, provide the reports referred to in clauses 2.13.26 or 2.13.28 to all Rule Participants and interested parties. However, the IMO is not required to provide a report to such a person if the IMO considers it is inappropriate in the circumstances, including without limitation, where there may be confidentiality issues.

2.14. Audit

2.14.1. The IMO must appoint one or more Market Auditors that may be used to conduct the audits described in clause 2.14.2 and 2.14.6(b).

2.14.2. The IMO must ensure that the Market Auditor carries out the audits of the matters identified under clause 2.14.3 no less than annually.

2.14.3. The IMO must ensure that the Market Auditor carries out the audits of such matters as the IMO considers appropriate, which must include:

Chapter 2

- (a) the compliance of the IMO's internal procedures and business processes with the Market Rules;
- (b) the IMO's compliance with the Market Rules and Market Procedures;
- (c) the IMO's market software systems and processes for software management.

2.14.4. The Market Auditor must provide the IMO with a report, and the IMO must within 30 Business Days of receiving the report either:

- (a) accept the report and any recommendations contained in it; or
- (b) prepare a separate report setting out the matters raised in the Market Auditor's report which the IMO accepts and those which it does not accept and setting out the IMO's reasons for that view.

2.14.5. The IMO must publish the Market Auditor's report and any report it prepared under clause 2.14.4(b) within 30 Business Days of receiving the Market Auditor's report.

2.14.6. In accordance with the Monitoring Protocol, the IMO must at least annually, and may more frequently where it reasonably considers that System Management may not be complying with the Market Rules and Market Procedures:

- (a) require System Management to demonstrate compliance with the Market Rules and Market Procedures by providing such records as are required to be kept under these Market Rules or any Market Procedure; or
- (b) subject System Management to an audit by the Market Auditor to verify compliance with the Market Rules and Market Procedures.

2.14.7. The IMO must annually provide to the Minister a report on System Management's compliance with the Market Rules and Market Procedures. The report must contain:

- (a) the results of audits performed under clause 2.14.6(b);
- (b) the results of any investigations of System Management's compliance with the Market Rules and Market Procedures carried out by the IMO under clause 2.13.10(b); and
- (c) details of any relevant information received under clause 2.14.6(a).

2.15. Monitoring and Reporting Protocols

2.15.1. Prior to Energy Market Commencement, the IMO must develop and implement a Monitoring Protocol.

2.15.2. The purpose of the Monitoring Protocol is to state how the IMO will implement its obligations under these Market Rules to monitor Rule Participants' behaviour for compliance with the Market Rules and Market Procedures.

2.15.3. The Monitoring Protocol must specify:

Chapter 2

- (a) the IMO's monitoring processes for assessing compliance with the Market Rules and Market Procedures by Rule Participants;
- (b) a process for System Management to demonstrate compliance with the Market Rules and Market Procedures and audit processes where the IMO requires such demonstration or an audit in accordance with clause 2.14.6;
- (c) a process for Rule Participants to report alleged breaches of the Market Rules or Market Procedures;
- (d) processes for investigations into alleged breaches of the Market Rules or Market Procedures;
- (e) guidelines for the IMO when issuing warnings about alleged breaches of the Market Rules or Market Procedures to Rule Participants under clause 2.13.10(c); and
- (f) the procedure for bringing proceedings in respect of Category B or C Market Rule breaches before the Energy Review Board.

2.15.4. Prior to Energy Market Commencement System Management must develop and implement a Monitoring and Reporting Protocol and seek the approval of the IMO for that Monitoring and Reporting Protocol.

2.15.5. The purpose of the Monitoring and Reporting Protocol is to state how System Management will implement its obligations under these Market Rules to monitor Rule Participant's behaviour for compliance with the Market Rules in accordance with clause 2.13.6 and with Market Procedures developed by System Management.

2.15.6. The Monitoring and Reporting Protocol must specify:

- (a) System Management's monitoring processes for assessing compliance with the Market Rules and Market Procedure by Market Participants; and
- (b) the provision of information about breaches or other information the IMO may request to the IMO.

2.15.7. The Monitoring Protocol developed by the IMO, and the Monitoring and Reporting Protocol developed by System Management are Market Procedures under these Market Rules, and must be developed and amended in accordance with clauses 2.9 and 2.10.

2.15.8. The IMO and the Economic Regulation Authority must agree a reporting protocol, which must specify:

- (a) the circumstances in and process by which the IMO may communicate to the Economic Regulation Authority information related to compliance with the Market Rules that may have a bearing on compliance with licences granted under the Electricity Industry Act; and

- (b) the circumstances in and process by which the Economic Regulation Authority may communicate to the IMO information related to compliance with licences granted under the Electricity Industry Act that may have a bearing on compliance with the Market Rules.

2.16. Monitoring the Effectiveness of the Market

Market Monitoring involves three key stages. First, collection and analysis of primary market data including bid data. This will be done on a regular basis by the IMO. This data is then provided to the ERA. The ERA will report annually to the Industry Minister on the effectiveness of the market and whether the market objectives are being met. It will also conduct irregular reviews of market behaviour where anomalous behaviour has been identified. Findings of these reviews will be provided in a report to the Minister. In both the regular and irregular reports, recommendations can be made to change the market rules to improve the market's effectiveness. Based on these recommendations, the Minister may issue directives to the IMO to develop Market Rule changes that would implement the recommendations.

2.16.1. The IMO is responsible for collection and primary analysis of data in accordance with this clause 2.16. The IMO must:

- (a) compile the data identified in the Market Surveillance Data Catalogue and provide that data to the Economic Regulation Authority; and
- (b) analyse the compiled data in accordance with clause 2.16.4 and provide the results of the analysis to the Economic Regulation Authority.

2.16.2. The IMO must develop a Market Surveillance Data Catalogue, which identifies data to be compiled concerning the market. The Market Surveillance Data Catalogue must identify the following data items:

- (a) the number of Market Generators and Market Customers in the market;
- (b) the number of participants in each Reserve Capacity Auction;
- (c) clearing prices in each Reserve Capacity Auction and STEM Auctions;
- (d) Balancing Data prices and other Standing Data prices used in Balancing;
- (dA) all Reserve Capacity Auction offers;
- (e) all bilateral quantities scheduled with the IMO;
- (f) all STEM Offers and STEM Bids, including both quantity and price terms;
- (g) [Blank]
- (gA) all Fuel Declarations;
- (gB) all Availability Declarations;
- (gC) all Ancillary Service Declarations;

Chapter 2

- (h) any substantial variations in STEM Offer and STEM Bid prices or quantities relative to recent past behaviour;
- (hA) any evidence that a Market Customer has significantly over-stated its consumption as indicated by its Net Contract Position with a regularity that cannot be explained by a reasonable allowance for forecast uncertainty or the impact of Loss Factors.

The behaviour by a Market Customer described in clause (hA) is prohibited by clause 6.7.4. This behaviour could be a symptom that a non-EGC generator supplying the Market Customer under a bilateral contract has caused the scheduling of additional energy from the Market Generator's facilities with the result in real-time that the Electricity Generation Corporation supplies less energy than it was contracted to supply under its own Bilateral Submissions (with it being settled at MCAP which may not reflect its actual costs). This feature could also be used to ensure that a non-EGC generator can remain committed overnight during periods of low demand ahead of the Electricity Generation Corporation. However, if the Market Customer addresses this over-supply in the STEM then this is acceptable, because to the extent that the Electricity Generation Corporation is scheduled down in the STEM, it will be compensated at the economic value of that energy (as defined by Electricity Generation Corporation STEM Bids). Note that this clause does not place any restrictions as to how generation levels can change relative to a Bilateral Submission (e.g., in the case of the Electricity Generation Corporation, as a result of its balancing obligations).

- (i) the capacity available through Balancing from Generators and Non-Scheduled Generators and Dispatchable Loads;
- (j) the frequency and nature of Dispatch Instructions to Market Participants other than the Electricity Generation Corporation;
- (k) the number and frequency of outages of Scheduled Generators and Non-Scheduled Generators, and Market Participants' compliance with the outage scheduling process;
- (l) the performance of Market Participants with Reserve Capacity Obligations in meeting their obligations;
- (m) details of Ancillary Service Contracts and Balancing Support Contracts that System Management enters into;
- (n) [Blank]
- (o) the number of Rule Change Proposals received, and details of Rule Change Proposals that the IMO has decided not to progress under clause 2.5.6; and
- (p) such other items of information as the IMO considers relevant to the functions of the IMO and the Economic Regulation Authority under this clause 2.16.

2.16.3. The IMO must publish the Market Surveillance Data Catalogue, and must republish this document whenever it changes.

Chapter 2

2.16.4. The IMO must undertake the following analysis of the data identified in the Market Surveillance Data Catalogue to calculate relevant summary statistics:

- (a) where applicable, calculation of the means and standard deviations of values in the Market Surveillance Data Catalogue;
- (b) monthly, quarterly and annual moving averages of prices for the STEM Auctions and Balancing;
- (c) statistical analysis of the volatility of prices in the STEM Auctions and Balancing;
- (cA) any consistent or significant variations between the Fuel Declarations, Availability Declarations, and Ancillary Service Declarations for, and the actual operation of, a Market Participant facility in real-time;
- (d) the proportion of time the prices in the STEM Auctions and through Balancing are at each Energy Price Limit;
- (e) correlation between capacity offered into the STEM Auctions and the incidence of high prices;
- (f) correlation between capacity available in the Balancing and the incidence of high prices; and
- (g) exploration of the key determinants for high prices in the STEM and Balancing, including determining correlations or other statistical analysis between explanatory factors that the IMO considers relevant and price movements; and
- (h) such other analysis as the IMO considers appropriate or is requested of the IMO by the Economic Regulation Authority.

2.16.5. The IMO must, on request from the Economic Regulation Authority, and in any event at least once each month, provide the Economic Regulation Authority with the data identified in the Market Surveillance Data Catalogue and the results of the analysis on that data referred to in clause 2.16.4.

2.16.6. Where the Economic Regulation Authority considers that it is necessary or desirable for the performance of its functions or the functions of the IMO under this clause 2.16, the Economic Regulation Authority may collect additional information from Rule Participants as follows:

- (a) the Economic Regulation Authority may issue a notice to one or more Rule Participants requiring them to provide specified data to the Economic Regulation Authority by a date (which the Economic Regulation Authority considers to be reasonable);
- (b) Market Participants must provide any information requested by the Economic Regulation Authority by the date specified in the notice; and

This will be a category C civil penalty provision.
--

Chapter 2

- (c) the Economic Regulation Authority must provide this information to the IMO where the Economic Regulation Authority considers that it is necessary or desirable for the performance of the IMO's functions under this clause 2.16.

2.16.7. Without limitation, additional information that can be collected by the Economic Regulation Authority includes:

- (a) cost data for the Electricity Generation Corporation, including actual fuel costs by Trading Interval;
- (b) System Management's operational records, including SCADA records, of the level of utilisation and fuel related data for each of the Electricity Generation Corporation's Registered Facilities by Trading Interval; and
- (c) the terms of Bilateral Contracts entered into by the Electricity Generation Corporation and the Electricity Retail Corporation.

Note that under clauses 2.16.6 and 2.16.14, the ERA can only collect and use this data in carrying out its functions under this clause 2.16 – i.e. in the case of the above data, primarily for market power assessment. The Electricity Generation Corporation and the Electricity Retail Corporation are not commercially accountable to the ERA.

2.16.8. Rule Participants may notify the IMO or the Economic Regulation Authority of behaviour that they consider reduces the effectiveness of the market, including behaviour related to market power, and the Economic Regulation Authority, with the assistance of the IMO, must investigate the behaviour identified in each relevant notification.

2.16.9. The Economic Regulation Authority is responsible for monitoring the effectiveness of the market in meeting the Wholesale Market Objectives and must investigate any market behaviour if it considers that the behaviour has resulted in the market not functioning effectively. The Economic Regulation Authority, with the assistance of the IMO, must monitor:

- (a) Ancillary Service Contracts and Balancing Support Contracts that System Management enters into and the criteria and process that System Management uses to procure Ancillary Services and balancing support services from other persons;
- (b) inappropriate and anomalous market behaviour, including behaviour related to market power and the exploitation of shortcomings in the Market Rules or Market Procedures by Rule Participants including, but not limited to:
 - i. prices in STEM Submissions, including Standing STEM Submissions, used in forming STEM Bids and STEM Offers that do not reflect the reasonable expectation of the short run marginal cost of generating the relevant electricity (including a reasonable allowance for profit after allowing for revenue provided by payments for Reserve Capacity);

Chapter 2

- ii. [Blank]
 - iii. Balancing Data price changes, and changes in other Standing Data prices used in Balancing, that cannot be justified by an underlying change in cost;
 - iv. Availability Declarations that may not reflect the reasonable expectation of a facilities availability, beyond outages of which System Management has been notified;
 - v. Ancillary Service Declarations that may not reflect the reasonable expectation of the ancillary services to be provided by a facility; and
 - vi. Fuel Declarations that may not reflect the reasonable expectation of the fuel that a facility will be run on in real-time.
- (c) market design problems or inefficiencies; and
- (d) problems with the structure of the market.

2.16.9A. The IMO must assist the monitoring activities identified in clause 2.16.9(b)(i) by examining prices in STEM Submissions, including Standing STEM Submissions, used in forming STEM Bids and STEM Offers against information collected from Rule Participants in accordance with clauses 2.16.6 and 2.16.7.

2.16.9B Where the IMO concludes that prices in STEM Submissions may not reflect the reasonable expectation of the short run marginal cost of generating the relevant electricity (including a reasonable allowance for profit after allowing for revenue provided by payments for Reserve Capacity) and the IMO considers that the behaviour relates to market power the IMO must:

- (a) as soon as practicable, request an explanation from the Market Participant which has made the relevant STEM Submission; and
- (b) by 4:00 PM on the Scheduling Day to which the Submission relates, advise the Economic Regulation Authority of its conclusions. The IMO advice must outline the reasons for the IMO's conclusions.

2.16.9C The Market Participant must submit the explanation requested under clause 2.16.9B within 2 Business Days from receiving the request.

2.16.9D The IMO must publish the explanation submitted under clause 2.16.9C on the Market Web Site as soon as practicable.

2.16.9E Where the Economic Regulation Authority receives an advice from the IMO under clause 2.16.9B(b) or receives a notification from a Rule Participant under clause 2.16.8, the Economic Regulation Authority must investigate the identified behaviour. Without limitation, for this purpose the Economic Regulation Authority must examine the IMO advice, any explanation received under clause 2.16.9C, any data already in the possession of the Economic Regulation Authority or additional

Chapter 2

data it requests from the relevant Market Participant under clause 2.16.6 to assist in the investigations.

2.16.9F The Economic Regulation Authority must publish the results of its investigations within 20 Business Days from receiving the IMO advice under clause 2.16.9B(b) or from receiving a notification from a Rule Participant under clause 2.16.8.

2.16.9G Where the Economic Regulation Authority determines that prices in the STEM Submission, subject to the investigation, did not reflect the reasonable expectation of the short run marginal cost of generating the relevant electricity (including a reasonable allowance for profit after allowing for revenue provided by payments for Reserve Capacity), the Economic Regulation Authority must request that the IMO refers the matter to the Energy Review Board.

2.16.9H Where the IMO receives a request under clause 2.16.9G the IMO must refer the relevant matter to the Energy Review Board requesting that a civil penalty be imposed on the relevant Market Participant.

2.16.9I Civil penalties imposed as a result of clause 2.16.9H must apply to each single occasion where a Market Participant was determined to have submitted prices that do not reflect the reasonable expectation of the short run marginal cost of generating the relevant electricity (including a reasonable allowance for profit after allowing for revenue provided by payments for Reserve Capacity). For the avoidance of doubt, "each single occasion" in this clause relates to each Trading Interval.

This will be a category C civil penalty provision.

2.16.9J Where a civil penalty is imposed in accordance with clause 2.16.9I, the civil penalty amount should be distributed amongst all Market Customers in proportion to their Market Fees calculated over the previous full 12 months, or part thereof if Market Commencement was less than 12 months prior to the date the civil penalty is received.

- 2.16.10. The Economic Regulation Authority must also review:
- (a) the effectiveness of the Market Rule change process and Procedure change process;
 - (b) the effectiveness of the compliance monitoring and enforcement measures in the Market Rules and Regulations;
 - (c) the effectiveness of the IMO in carrying out its functions under the Regulations, the Market Rules and Market Procedures; and
 - (d) the effectiveness of System Management in carrying out its functions under the Regulations, the Market Rules and Market Procedures.

Chapter 2

- 2.16.11. The Economic Regulation Authority must provide to the Minister a report on the effectiveness of the market and dealing with the matters identified in clauses 2.16.9 and 2.16.10:
- (a) at least annually; and
 - (b) more frequently where the Economic Regulation Authority considers that the market is not effectively meeting the Wholesale Market Objectives.
- 2.16.12. A report referred to in clause 2.16.11 must contain:
- (a) a summary of the information and data compiled by the IMO and the Economic Regulation Authority under clause 2.16.1;
 - (b) the Economic Regulation Authority's assessment of the effectiveness of the market, including the effectiveness of the IMO and System Management in carrying out their functions, with discussion of each of:
 - i. the Reserve Capacity market;
 - ii. the market for bilateral contracts for capacity and energy;
 - iii. the STEM;
 - iv. Balancing;
 - v. the dispatch process;
 - vi. planning processes; and
 - vii. the administration of the market, including the Market Rule change process;
 - (c) an assessment of any specific events, behaviour or matters that impacted on the effectiveness of the market; and
 - (d) any recommended measures to increase the effectiveness of the market in meeting the Wholesale Market Objectives to be considered by the Minister.
- 2.16.13. In carrying out its responsibilities under clause 2.16.9(b), the Economic Regulation Authority must:
- (a) estimate the prevalence of such behaviour;
 - (b) estimate the cost to end users of such behaviour;
 - (c) estimate the impact of such behaviour on the effectiveness of the market in meeting the market objectives;
 - (d) consult with Market Participants on the impacts of such behaviour;
 - (e) estimate the benefits and costs of any recommended measure to reduce such behaviour. The Economic Regulation Authority:
 - i. may use market simulation tools to estimate the benefits and costs;
 - ii. must give consideration to:

1. the probability of success of the measure in reducing the behaviour;
 2. the implications on the efficiency of the market of implementing the measure; and
 3. the costs of compliance as a result of implementing the measure;
- (f) where the benefits of any change are estimated to exceed the cost, make recommendations to the Minister for implementing the measures in a report under clause 2.16.11; and
- (g) provide details of its findings in a report to the Minister under clause 2.16.11.
- 2.16.14. The Economic Regulation Authority must use any information collected under this clause 2.16, including information provided to it by the IMO, only for the purpose of carrying out its functions under this clause 2.16. The Economic Regulation Authority must treat information collected as confidential and must not publish any of that information other than in accordance with this clause 2.16. The IMO must use information provided to it by the Economic Regulation Authority under clause 2.16.6(c) only for the purpose of carrying out its functions under this clause 2.16. The IMO must treat information provided to it by the Economic Regulation Authority under clause 2.16.6(c) as confidential and must not publish any of that information other than in accordance with this clause 2.16.
- 2.16.15. Where the Economic Regulation Authority provides a report to the Minister in accordance with clause 2.16.11, it must, after consultation with the Minister, publish a version of the report which has confidential or sensitive data aggregated or removed. An assessment of the results of the Economic Regulation Authority's monitoring under clause 2.16.9(b) must be included in the published version of the report.
- 2.16.16. In respect of any reports published under this clause 2.16, only aggregate or summary statistics of confidential data may be published. The aggregation must be at a level sufficient to ensure the underlying data cannot be identified. Where aggregated data is derived from confidential data collected from three or less Market Participants, then this data should not be published.

Reviewable Decisions and Disputes

2.17. Reviewable Decisions

The legislation mandates that all non-reviewable decisions be specified in the Regulations (by class), and this will need to be taken into account in the final wording here, once the Regulations have been made.

The Reviewable Decision provisions only apply to IMO decisions. Decisions made by System Management are not Reviewable Decisions, although some are subject to further

Chapter 2

review by the IMO where this is set out in the Market Rules (eg outage planning). In addition rule breach provisions may apply where System Management has not acted in accordance with the Market Rules.

Procedural Reviews can apply to either the IMO or System Management, and are reviews of the process that the IMO or System Management has gone through in developing a rule change or Market Procedure change.

2.17.1. Decisions by the IMO made under the following clauses are Reviewable Decisions:

(a) clause 2.3.7;

The IMO appoints and removes members of the Market Advisory Committee.

(b) clauses 2.13.28;

The IMO publishes a report on enforcement actions.

(c) clause 2.28.16;

The IMO exempts a person from having to register as a Rule Participant.

(d) clauses 2.30.4 and 2.30.8;

Market Participant applies to the IMO for facility aggregation, or IMO decides that facility must be disaggregated.

(dA) clauses 2.30A.2 and 2.30A.5;

Market Participant applies to the IMO for exemption from funding Spinning Reserve, or IMO decides to change the facilities status in this regard.

(dB) clauses 2.30B.4, 2.30B.6 and 2.30B.7;

Market Participant applies to the IMO to be treated as an Intermittent Load, or the IMO decides to cease treating a load as an Intermittent Load.

(e) clause 2.31.10;

The IMO accepts or rejects applications for registration/deregistration/transfer of participant or facility.

(f) clause 2.34.7;

The IMO rejects a change in a participant's standing data

(g) clause 2.34.11;

The IMO requires a change in a participant's standing data because it is inaccurate.

(h) clauses 2.37.1 to 2.37.3;

Chapter 2

The IMO determines the Credit Limit for a Market Participant

- (i) clause 2.37.6 and 2.37.7;

The IMO determines the Credit Limit for a Network Operator.

- (j) clauses 4.9.9 and 4.28B.4;

The IMO sets the Certified Capacity, Reserve Capacity Obligations and, in the case of clause 4.9.9, any Security Deposit for a facility.

- (k) clause 4.16.1;

The IMO determines that a Reserve Capacity Auction will not take place because sufficient capacity has been procured bilaterally.

- (l) clause 4.27.7;

The IMO restricts amount of planned maintenance allowed under Reserve Capacity obligations

- (m) clauses 4.28.7 and 4.28.11;

The Individual Reserve Capacity Requirements determined by the IMO

- (n) clauses 5.2.6 and 5.2.7;

The IMO identifies whether more than one party could provide the Network Control Services

- (o) clause 5.3.6; and

The IMO determines the Network Control Service certification for a facility

- (p) clause 10.2.1.

The IMO decides the confidentiality status of market related information.

Note that the lists above do not contain decisions on the following:

Areas where the IMO's decision is already a review of another person's decision – eg an IMO review of a loss factor calculation, or an IMO review of an outage decision

Decisions on the results of auctions – the Reserve Capacity auction, STEM auction and Network Control Service tender decisions are not reviewable decisions.

Operational type decisions – e.g. accepting submissions, calculating prices. In cases where the IMO has not performed these processes in accordance with the Market Rules the market rule breach provisions may apply.

Chapter 2

Settlement calculations – these are dealt with by the settlement disagreement/dispute process.

2.17.2. Decisions by the IMO made under the following clauses may be subject to a Procedural Review:

- (a) clauses 2.5.9, 2.6.4(f) and 2.7.8(e);

The IMO subjects Rule Change Proposal to Fast Track or accepts or rejects Market Rule change.

- (b) clauses 2.10.13, 2.10.14.

The IMO accepts or rejects Procedure change.

2.17.3. In accordance with the Regulations, a Rule Participant may apply to the Energy Review Board for a review of Reviewable Decisions or a decision made under clauses subject to Procedural Review.

The remaining Reviewable Decision and Procedural Review arrangements are expected to be as follows. The Energy Review Board will review the decision, and may affirm the decision, vary the decision, set aside the decision and make a substitute decision, or set aside the decision and send the decision back to the IMO/System Management who will make a new decision in accordance with any directions or recommendations of the Energy Review Board. Decisions by the Energy Review Board on Reviewable Decisions and Procedural Reviews may not be appealed, except on matters of law. Such appeals may be made to the Supreme Court. Some of these provisions will be in Regulations, although some of the process details may appear in the Market Rules once the Regulations are completed.

2.18. Disputes

2.18.1. The dispute process set out in clauses 2.18, 2.19 and 2.20 applies to any dispute concerning:

- (a) the application or interpretation of these Market Rules;
- (b) the failure of Rule Participants to reach agreement on a matter where these Market Rules require agreement or require the Rule Participants to negotiate in good faith with a view to reaching agreement;
- (c) payment of moneys under, or the performance of any obligation under, these Market Rules,

but does not apply to:

- (d) any matter that is identified as a Reviewable Decision or is subject to Procedural Review; or

Chapter 2

- (e) a matter that arises under a contract between Rule Participants, unless the IMO is a party to the contract and the contract provides that the dispute process applies.

Contractual disputes will be dealt with via dispute mechanisms set out in the contract.

2.18.2. For the purposes of these Market Rules, the “Dispute Participants” are the Rule Participants raising the dispute, the IMO and all Rule Participants named in a Notice of Dispute or joined to the dispute in accordance with clause 2.19.5.

Rule Participants includes the IMO and System Management

2.18.3. At any time during the course of resolving a dispute a Dispute Participant may refer a question of law to a court of competent jurisdiction.

2.18.4. Dispute Participants must not agree to actions to be taken in resolution of a dispute that are inconsistent with the Market Rules.

2.19. First Stage Dispute Resolution

2.19.1. Where a Rule Participant wishes to raise a dispute with another Rule Participant concerning a matter to which this dispute process applies, it may issue a Notice of Dispute to each other Rule Participant that is a party to the dispute within 12 months of the matter giving rise to the dispute.

2.19.2. The Rule Participant raising the dispute may name any Rule Participant in a Notice of Dispute that the Rule Participant raising the dispute considers may be affected by the dispute or resolution of the dispute.

2.19.3. The Notice of Dispute must be in writing and must contain:

- (a) the date on which the Notice of Dispute was issued;
- (b) the identity of the Rule Participant issuing the Notice of Dispute;
- (c) the identities of the other Rule Participants party to the dispute;
- (d) the details of the dispute, including a description of the disputed actions, and the time and date when the disputed actions occurred; and
- (e) the contact person for the Rule Participant issuing the dispute, and their mailing address.

2.19.4. A Rule Participant receiving a Notice of Dispute under clause 2.19.1 must supply a confirmation of the receipt of the Notice of Dispute within two Business Days of receipt of the Notice of Dispute, including details of a contact person and their mailing address.

Chapter 2

2.19.5. Where the IMO receives a Notice of Dispute and it considers that a Rule Participant not named in the Notice of Dispute may be affected by the dispute or resolution of the dispute, it may, within 10 Business Days of receiving the Notice of Dispute, join the Rule Participant to the dispute by notifying the Rule Participant of the dispute and providing a copy of the Notice of Dispute.

2.19.6. The Chief Executive Officers, or their designated representatives with authority to resolve the dispute, from all Dispute Participants must make reasonable endeavours to meet on one or more occasions, and to attempt in good faith and using their best endeavours at all times to resolve the dispute.

In the case of disputes involving System Management, in some circumstances the CEO of the Electricity Networks Corporation may not be appropriate person, and the general manager of System Management should be used.

2.19.7. A dispute must be escalated to the second stage dispute resolution process in clause 2.20 if the Dispute Participants have not resolved the dispute (as evidenced by the terms of the settlement being reduced to writing and signed by each Chief Executive Officer) within:

- (a) a time period agreed by all Dispute Participants; or
- (b) if no time period is agreed by all Dispute Participants, within 60 days of the date on which the Notice of Dispute was issued.

2.20. Second Stage Dispute Resolution

2.20.1. Where any Dispute is not resolved as provided for in clause 2.19 then the Dispute Participants must give consideration to resolving the dispute through mediation, conciliation, arbitration or alternative dispute resolution methods, using an independent body agreed between the Dispute Participants.

2.20.2. If any Dispute is not resolved as provided for in clause 2.19 and a Dispute Participant has given consideration to resolving the dispute in accordance with clause 2.20.1, then that Dispute Participant may commence proceedings before a court of competent jurisdiction in relation to the dispute.

Market Consultation

2.21. Market Consultation

2.21.1. The IMO must consult on such matters with such persons and over such timeframes as are specified in these Market Rules.

2.21.2. The IMO must:

- (a) conduct its consultation processes in good faith; and

- (b) ensure that these consultation processes allow a reasonable opportunity for relevant stakeholders to present their views.

2.21.3. System Management must consult on such matters with such persons and over such timeframes as are specified in these Market Rules.

2.21.4. System Management must:

- (a) conduct its consultation processes in good faith; and
- (b) ensure that these consultation processes allow a reasonable opportunity for relevant stakeholders to present their views.

Budgets and Fees

2.22. Determination of the IMO's budget

2.22.1. For the purposes of this clause 2.22, the services provided by the IMO are:

- (a) market operation services, including the IMO's operation of the Reserve Capacity market, STEM and Balancing and the IMO's settlement and information release functions;
- (b) system planning services, including the IMO's performance of the Long Term PASA function and functions under Chapter 5; and
- (c) market administration services, including the IMO's performance of the Market Rule change process, Market Procedure change process, the operation of the Market Advisory Committee and other consultation, monitoring, enforcement, audit, registration related functions and other functions under these Market Rules.

2.22.2. Prior to the establishment of the IMO the Minister must determine the budget of the IMO, for each of the services described in clause 2.22.1.

Note that IMO costs for ERB appeals and legal proceeding will have to be factored into the IMO budget.

2.22.3. For the Review Period, the IMO must seek the approval of its Allowable Revenue from the Economic Regulation Authority for each of the services described in clause 2.22.1 in accordance with the following:

- (a) by 30 November of the year prior to the start of the Review Period, the IMO must submit a proposal for its Allowable Revenue over the Review Period;
- (b) the Economic Regulation Authority must undertake a public consultation process in approving the Allowable Revenue for the IMO for a Review Period, which must include publishing an issues paper and issuing an invitation for public submissions;

Chapter 2

- (c) by 31 March of the year in which the Review Period commences, the Economic Regulation Authority must determine the Allowable Revenue of the IMO for the Review Period for each of the services described in clause 2.22.1.

2.22.4. Where the Economic Regulation Authority does not make a determination by the date specified in clause 2.22.3(c), the Allowable Revenue from the previous Review Period, or the budget determined by the Minister under clause 2.22.2, as applicable, will continue to apply until the Economic Regulation Authority makes a determination.

2.22.5. Following the establishment of the IMO, by 30 April each year, the IMO must prepare a budget proposal for each of the services described in clause 2.22.1 for the coming Financial Year and submit it to the Minister.

2.22.6. Following the first determination of the Allowable Revenue of the IMO by the Economic Regulation Authority under clause 2.22.3 and subject to clauses 2.22.7 and 2.22.8, the budget proposal must be consistent with the Allowable Revenue determined by the Economic Regulation Authority for the relevant Review Period.

2.22.7. Where the revenue earned for the services described in clause 2.22.1 via Market Fees in the previous Financial Year is greater than or less than the IMO's expenditure for that Financial Year, the current year's budget must take this into account by decreasing the budgeted revenue by the amount of the surplus or adding to the budgeted revenue the amount of any shortfall, as the case may be.

2.22.8. Where, taking into account any adjustment under clause 2.22.7, the budget proposal is likely to result in revenue recovery, over the relevant Review Period, more than 15% greater than the Allowable Revenue determined by the Economic Regulation Authority, the IMO must apply to the Economic Regulation Authority to reassess the Allowable Revenue. The IMO must endeavour to make such an application in sufficient time to allow its budget proposal to be approved under clause 2.22.9 before the commencement of the Financial Year to which it relates. The Economic Regulation Authority may amend a determination under clause 2.22.3(c) if the IMO makes an application under this clause 2.22.8. Clause 2.22.3(b) applies in the case of an application under this clause 2.22.8.

2.22.9. The Minister must make a decision on the budget proposal within 30 Business Days, and notify the IMO of the decision. The Minister may:

- (a) approve the budget proposal; or
- (b) refer the budget proposal back to the IMO for re-consideration in accordance with any directions or recommendations of the Minister.

When the Minister refers the budget proposal back to the IMO, the IMO must reconsider the proposal in accordance with any directions or recommendations of the Minister and re-submit a revised budget proposal to the Minister, in which case this clause 2.22.9 applies.

Chapter 2

- 2.22.10. Where the Minister does not approve a budget proposal in accordance with clause 2.22.9 prior to the commencement of the Financial Year to which it relates, the prior year's budget and any market fees derived from that budget in accordance with clause 2.24 continue to apply until the Minister makes a decision.
- 2.22.11. The IMO must publish the approved budget within five Business Days following the Minister approving the budget in accordance with clause 2.22.9.
- 2.22.12. The Economic Regulation Authority must take the following into account when determining the Allowable Revenue of the IMO:
- (a) the Allowable Revenue must be sufficient to cover the forward looking costs of providing the services described in clause 2.22.1 and performing its functions and obligations under these Market Rules in accordance with the following principles:
 - i. recurring expenditure requirements and payments are recovered in the year of the expenditure;
 - ii. capital expenditures are to be recovered through the depreciation and amortisation of the assets acquired by the capital expenditure in a manner that is consistent with generally accepted accounting principles;
 - iii. costs incurred by the IMO that are related to market establishment, as designated by the Minister, are to be recovered over a period determined by the Minister from Energy Market Commencement; and
 - iv. notwithstanding paragraphs (i), (ii) and (iii), expenditure incurred, and depreciation and amortisation charged, in relation to any Declared Market Project are to be recovered over the period determined for that Declared Market Project.
 - (b) the Allowable Revenue must include only costs which would be incurred by a prudent provider of the services described in clause 2.22.1, acting efficiently, seeking to achieve the lowest practicably sustainable cost of delivering the services described in clause 2.22.1 in accordance with these Market Rules, while effectively promoting the Wholesale Market Objectives.
 - (c) where possible, the Economic Regulation Authority should benchmark the Allowable Revenue against the costs of providing similar services in other jurisdictions.
- 2.22.13. Subject to clause 2.22.14, the IMO may declare a project to be a Declared Market Project if:
- (a) the project involves:
 - i. a major change to a function of the IMO or System Management under these Market Rules; or

- ii. a major change to any of the computer software or systems that the IMO or System Management uses in the performance of any of its functions under these Market Rules; and
- (b) the IMO estimates that the cost to implement the changes would cause either the IMO's budget or System Management's budgets during the current Review Period to exceed their respective approved Allowable Revenue by more than 15%.

2.22.14. Before the IMO commences a Declared Market Project the IMO must obtain approval from the Economic Regulation Authority for an increase in the Allowable Revenue relevant to the Declared Market Project, including the period over which the incremental Allowable Revenue will apply.

2.23. Determination of System Management's budget

2.23.1. For the purposes of this clause 2.23, the services provided by System Management are:

- (a) system operation services, including all of System Management's functions and obligations under these Market Rules except the provision of Ancillary Services; and
- (b) System Management's functions and obligations under these Market Rules in relation to the provision of Ancillary Services.

2.23.2. For each year until the process referred to in clause 2.23.3 to 2.23.10 applies, the Shareholding Minister must determine the budget of System Management for each of the services described in clause 2.23.1.

2.23.3. For each Review Period, System Management must seek the approval of its Allowable Revenue from the Economic Regulation Authority in accordance with the following:

- (a) by 30 November of the year prior to the start of the Review Period, System Management must submit a proposal for its costs over the Review Period;
- (b) the Economic Regulation Authority must undertake a public consultation process, which must include publishing an issues paper and issuing an invitation for public submissions;
- (c) by 31 March of the year in which the Review Period commences, the Economic Regulation Authority must determine the Allowable Revenue of System Management for the Review Period for each of the services described in clause 2.23.1.

2.23.4. Where the Economic Regulation Authority does not make a determination by the date specified in clause 2.23.3(c), the Allowable Revenue from the previous Review Period, or the budget determined by the Shareholding Minister under clause 2.33.1,

Chapter 2

as applicable, will continue to apply until the Economic Regulation Authority makes a determination.

- 2.23.5. Following the first determination of the Allowable Revenue of System Management by the Economic Regulation Authority in accordance with clause 2.23.3, by 30 April each year System Management must prepare a budget proposal for each of the services described in clause 2.23.1 for the coming Financial Year.
- 2.23.6. Subject to clauses 2.23.7 and 2.23.8, the budget proposal must be consistent with the Allowable Revenue determined by the Economic Regulation Authority for the relevant Review Period.
- 2.23.7. Where the revenue earned for a service described in clause 2.23.1 via System Operation Fees or Ancillary Service payments in the previous Financial Year is greater than or less than System Management's expenditure for that Financial Year, the current year's budget must take this into account by decreasing the budgeted revenue by the amount of the surplus or adding to the budgeted revenue the amount of any shortfall, as the case may be.
- 2.23.8. Where, taking into account any adjustment under clause 2.23.7, the budget proposal is likely to result in revenue recovery, over the relevant Review Period, more than 15% greater than the Allowable Revenue determined by the Economic Regulation Authority, System Management must apply to the Economic Regulation Authority to reassess the Allowable Revenue. System Management must endeavour to make such an application in sufficient time to meet its obligation under clause 2.23.9. The Economic Regulation Authority may amend a determination under clause 2.23.3(c) if System Management makes an application under this clause 2.23.8. Clause 2.23.3(b) applies in the case of an application under this clause 2.23.8.
- 2.23.9. System Management must provide a copy of the budget proposal to the IMO by 30 April each year. The IMO must review the budget proposal and submit a report containing advice on whether System Management's budget is consistent with the Allowable Revenue determined by the Economic Regulation Authority to the Minister by 31 May.
- 2.23.10. The budget proposal must be reflected in the Statement of Corporate Intent for the Electricity Networks Corporation and must be consistent with the segregation of System Management from other business units of the Electricity Networks Corporation.
- 2.23.11. System Management must provide the budget to the IMO and the IMO must publish the budget by 30 June each year.
- 2.23.12. The Economic Regulation Authority must take the following into account when determining the Allowable Revenue of System Management:

- (a) the Allowable Revenue must be sufficient to cover the forward looking costs of providing the services described in clause 2.23.1 and performing its functions and obligations under these Market Rules in accordance with the following principles:
- i. recurring expenditure requirements and payments are recovered in the year of the expenditure;
 - ii. capital expenditures are to be recovered through the depreciation and amortisation of the assets acquired by the capital expenditure in a manner that is consistent with generally accepted accounting principles;
 - iii. costs incurred by System Management that are related to market establishment, as designated by the Minister, are to be recovered over a period determined by the Minister from Energy Market Commencement; and
 - iv. notwithstanding paragraphs (i), (ii) and (iii), expenditure incurred, and depreciation and amortisation charged, in relation to any Declared Market Project are to be recovered over the period determined for that Declared Market Project.
- (b) the Allowable Revenue must include only costs which would be incurred by a prudent provider of the services described in clause 2.23.1, acting efficiently, in accordance with good electricity industry practice, seeking to achieve the lowest practicably sustainable cost of delivering the services described in clause 2.23.1 in accordance with these Market Rules, while effectively promoting the Wholesale Market Objectives;
- (c) where possible, the Economic Regulation Authority should benchmark the Allowable Revenue against the costs of providing similar services in other jurisdictions; and
- (d) the determination of the Allowable Revenue of Ancillary Service provision must take into account the payment structure set out in clause 3.13, and the Economic Regulation Authority must determine values for:
- i. the reserve availability payment margin applying for Peak Trading Intervals, `Margin_Peak`, which must take account of:
 1. the margin `the Electricity Generation Corporation` could reasonably have been expected to earn on energy sales forgone due to the supply of Spinning Reserve during Peak Trading Intervals;
 2. the loss in efficiency of the `Electricity Generation Corporation` Registered Facilities that `System Management` has scheduled to provide Spinning Reserve during Peak Trading Intervals that could reasonably be expected due to the scheduling of those reserves;

- ii. the reserve availability payment margin applying for Off-Peak Trading Intervals, Margin_Off-Peak, which must take account of:
 1. the margin the Electricity Generation Corporation could reasonably have been expected to earn on energy sales forgone due to the supply of Spinning Reserve during Off-Peak Trading Intervals;
 2. the loss in efficiency of the Electricity Generation Corporation Registered Facilities that System Management has scheduled to provide Spinning Reserve during Off-Peak Trading Intervals that could reasonably be expected due to the scheduling of those reserves;
 - iii. Cost_LRD, which must cover the costs for providing the Load Rejection Reserve, System Restart, and Dispatch Support Ancillary Services.
- (e) the determination of the Allowable Revenue of Ancillary Service provision must take into account Ancillary Service Contracts that System Management has entered into.

2.24. Determination of Market Fees

2.24.1. The fees charged by the IMO are:

- (a) Market Fees, System Operation Fees and Regulator Fees determined in accordance with clause 2.24.2; and
- (b) Application Fees described in clauses 2.33.1(a), 2.33.2(a), 2.33.3(a), 2.33.4(a), 2.33.5(a), and 4.9.3(c).

2.24.2. Before 30 June each year, the IMO must determine and publish the level of the Market Fee rate, System Operation Fee rate and Regulator Fee rate and the level of each of the Application Fees to apply over the year starting 1 July.

2.24.3. At the same time, the IMO must also publish an estimate of the total amount of revenue to be earned from:

- (a) Market Fees collected for the IMO's:
 - i. market operation services;
 - ii. system planning services; and
 - iii. market administration services,

where the amounts to be earned for each service is equal to the relevant costs in the IMO's approved budget published in accordance with clause 2.22.11;

- (b) System Operation Fees collected for System Management's:

- i. system operation services;

where the amount to be earned is equal to the relevant costs in System Management's budget published in accordance with clause 2.23.11; and

- (c) Regulator Fees collected for the Economic Regulation Authority's monitoring and regulation services,

where the amount must be consistent with the amount notified in accordance with clause 2.24.6.

2.24.4. The Market Fee rate, System Operation Fee rate and Regulator Fee rate should be set at a level that the IMO estimates will earn revenue equal to the relevant estimate of revenue under clause 2.24.3.

2.24.5. The Economic Regulation Authority may recover a portion of its budget determined by the Minister responsible for the Economic Regulation Authority which corresponds to the costs incurred by the Economic Regulation Authority in undertaking its Wholesale Electricity Market related functions and other functions under these Market Rules from the collection of Regulator Fees under these Market Rules.

2.24.6. By the date which is five Business Days prior to 30 June each year, the Economic Regulation Authority must notify the IMO of the dollar amount that the Economic Regulatory Authority may recover under clause 2.24.5.

2.24.7. The level of each Application Fee:

- (a) must reflect the estimated average costs to the IMO of processing that type of application;
- (b) must be consistent with the Allowable Revenue approved by the Economic Regulation Authority; and
- (c) may be different for different classes of Rule Participant and different classes of facility.

2.25. Payment of Market Participant Fees

2.25.1. The IMO must charge a Market Participant the relevant payment amount for Market Fees, System Operation Fees and Regulator Fees for a Trading Month in accordance with clause 9.13.

2.25.2. Each Market Participant must pay the relevant payment amount for Market Fees, System Operation Fees and Regulator Fees in accordance with Chapter 9.

2.25.3. Following receipt of a payment contemplated by clause 2.25.2, the IMO must:

- (a) pay each of System Management and the Economic Regulation Authority in accordance with Chapter 9 an amount corresponding to the part of the payment received multiplied by the relevant proportionality factor;

- (b) transfer to the fund established under clause 9.22.9 in accordance with Chapter 9 an amount corresponding to the part of the payment received multiplied by the relevant proportionality factor,:

2.25.4. The relevant proportionality factor for the IMO, System Management or the Economic Regulatory Authority for a Financial Year is:

- (a) the estimate of the total amount to be earned from Market Fees, System Operation Fees or Regulator Fees (as applicable) in respect of its services published for the relevant year under clause 2.24.3; divided by
- (b) the estimate of the total amount to be earned from Market Fees, System Operation Fees and Regulator Fees in respect of all services published for the relevant year under clause 2.24.3.

2.25.5. Rule Participants must pay the relevant Application Fee upon submitting an application form in accordance with clause 2.31.2, or in accordance with clause 4.9.3, as applicable.

Maximum and Minimum Prices and Loss Factors

2.26. Economic Regulation Authority Approval of Maximum and Minimum Prices

The IMO recalculates the Maximum Reserve Capacity Price and Energy Price Limits every year based on formulae in the Market Rules, but where it considers that a different value is required for the effective operation of the market, it can carry out a review process and revise the value. The revision is subject to ERA approval.

2.26.1. Where the IMO has proposed a revised value for the Maximum Reserve Capacity Price in accordance with clause 4.16 or a change in the value of one or more Energy Price Limits in accordance with clause 6.20, the Economic Regulation Authority must:

- (a) review the report provided by the IMO, including all submissions received by the IMO in preparation of the report;
- (b) make a decision as to whether or not to approve the revised value for the Maximum Reserve Capacity Price or any value comprising the Energy Price Limits;
- (c) in making its decision, consider:
 - i. whether the proposed revised value for the Maximum Reserve Capacity Price or Energy Price Limit proposed by the IMO reasonably reflects the application of the method and guiding principles described in clauses 4.16 or 6.20 (as applicable);
 - ii. whether the IMO has carried out an adequate public consultation process; and

Chapter 2

- (d) notify the IMO as to whether or not it has approved the revised value.

2.26.2. Where the Economic Regulation Authority rejects a revised Maximum Reserve Capacity Price or the Energy Price Limits submitted by the IMO it must give reasons and may direct the IMO to carry out all or part of the review process under clause 4.16 or 6.20 (as applicable) again in accordance with any directions or recommendations of the Economic Regulation Authority.

2.26.3. The Economic Regulation Authority must review the methodology for setting the Maximum Reserve Capacity Price and the Energy Price Limits not later than the fifth anniversary of the first Reserve Capacity Auction and, subsequently, not later than the fifth anniversary of the completion of the preceding review under this clause

2.26.3. A review must examine:

- (a) the level of competition in the market;
- (b) the level of market power being exercised and the potential for the exercise of market power;
- (c) the effectiveness of the methodology in curbing the use of market power;
- (d) historical Reserve Capacity Offers and the proportion of Reserve Capacity Offers with prices equal to the Maximum Reserve Capacity Price;
- (e) historical STEM Bids and STEM Offers and the proportion of STEM Bids and Offers with prices equal to the Energy Price Limits;
- (f) the appropriateness of the parameters and methodology in clauses 4.16 and Appendix 4 for recalculating the Maximum Reserve Capacity Price;
- (g) the appropriateness of the parameters and methodology in clause 6.20 for recalculating the Energy Price Limits;
- (h) the performance of Reserve Capacity Auctions, STEM Auctions and Balancing in meeting the Wholesale Market Objectives; and
- (i) other matters which the Economic Regulation Authority considers relevant.

2.26.4. The Economic Regulation Authority must provide a report on the review to the Minister.

2.27. Determination of Loss Factors

2.27.1. By 1 June of each year Network Operators must calculate and provide to the IMO Loss Factors for each connection point in their Network at which is connected a:

- (a) Scheduled Generator;
- (b) Non-Scheduled Generator;
- (c) Non-Dispatchable Load;
- (d) Interruptible Load;

Chapter 2

- (e) Curtailable Load; or
- (f) Dispatchable Load

2.27.2. In calculating Loss Factors, Network Operators must apply the following principles:

- (a) Loss Factors are static and apply to each connection point until new Loss Factors are calculated in accordance with clause 2.27.1 or 2.27.4(d);
- (b) Loss Factors must represent the marginal losses for a connection point relative to the Reference Node, averaged over all Trading Intervals in a year, weighted by the absolute value of the net demand at that connection point during the Trading Interval;
- (c) Loss Factors must be calculated using:
 - i. generation and load meter data from the preceding 12 months; and
 - ii. an appropriate network load flow software package; and
- (d) Loss Factors must include transmission and distribution losses;
- (e) a specific Loss Factor must be calculated for each:
 - i. Scheduled Generator;
 - ii. Non-Scheduled Generator;
 - iii. Curtailable Load;
 - iv. Interruptible Load;
 - v. Dispatchable Load; and
 - vi. Non-Dispatchable Load above 1000kVA peak consumption;
- (f) the same Loss Factor will apply to all Non-Dispatchable Loads less than 1000kVA peak consumption, and will be determined on an averaged basis.

2.27.2A For the purpose of these Market Rules, where a Loss Factor must be applied to a Notional Wholesale Meter value then the loss factor described in clause 2.27.2(f) is to apply.

2.27.3. The IMO must publish the Loss Factors as soon as practicable after receiving them from all Network Operators.

2.27.3A. Once all Loss Factors are published in accordance with clause 2.27.3 or where one or more Loss Factors are changed in accordance with clauses 2.27.4(e) or 2.27.5 the IMO must publish the time from which the Loss Factor or Loss Factors will apply, where this must be from the commencement of a Trading Day.

2.27.3B. In setting the time from which a Loss Factor or Loss Factors will apply in accordance with clause 2.27.3A the IMO must allow sufficient time for Market Participants to identify and update Standing Data that is dependent on Loss Factors.

Chapter 2

2.27.4. A Market Participant may seek a re-assessment by the IMO of any Loss Factor applying to a Scheduled Generator, Non-Scheduled Generator, Curtailable Load, Interruptible Load, Dispatchable Load or Non-Dispatchable Load registered by that Market Participant in accordance with the following process:

- (a) the Market Participant must apply to the IMO in writing within 15 Business Days of receiving the notification of the Loss Factors, stating the Loss Factors that it believes to be in error and its reasons for believing that the Loss Factors should take some other value;
- (b) upon receiving such an application, the IMO must:
 - i. within two Business Days notify the relevant Network Operator that the IMO intends to carry out an audit of the Loss Factor calculation; and
 - ii. within 25 Business Days audit the Loss Factor calculation.
- (c) the relevant Network Operator must cooperate with the audit of the Loss Factor calculation by providing reasonable access to the data and calculations used in producing the Loss Factor.
- (d) Where the audit reveals an error in the Loss Factor calculation, the IMO must direct the Network Operator to recalculate the Loss Factor, and may instruct the Network Operator to recalculate other Loss Factors provided by that Network Operator.
- (e) Where the IMO directs the Network Operator to recalculate a Loss Factor, then the Network Operator must do so, and must provide the recalculated Loss Factor to IMO. The recalculated Loss Factor is substituted for the value previously applied with effect from the time published by the IMO in accordance with clause 2.27.3A.

2.27.5. Where a Network Operator fails to provide the IMO with a Loss Factor in accordance with clause 2.27.1 or 2.27.4(d), the IMO must continue to use the equivalent Loss Factor from the previous year until such time as the Network Operator has provided the IMO with the new Loss Factor and that Loss Factor has taken effect. The recalculated Loss Factor is substituted for the value previously applied with effect from the time published by the IMO in accordance with clause 2.27.3A.

2.27.6. The IMO must document standards, methodologies and procedures to be used in determining the Loss Factors in the Market Operations Procedure and Network Operators must follow that documented Market Procedure when determining the Loss Factors.

Participation and Registration

2.28. Rule Participants

2.28.1. The classes of Rule Participant are:

Chapter 2

- (a) Network Operator;
- (b) Market Generator;
- (c) Market Customer;

The concept of a Metering data Agent is still used in the Market Rules, but it will now simply be a Network Operator, and does not require a separate registration.

- (cA) Ancillary Service Providers;
- (d) System Management; and
- (e) the IMO.

2.28.2. Subject to clauses 2.28.3 and 2.28.16, a person who owns, controls or operates a transmission system or distribution system which forms part of the South West Interconnected System, or is electrically connected to that system, must register as a Rule Participant in the Network Operator class.

2.28.3. A person that owns, controls or operates a transmission system or distribution system may, but is not required to, register as a Rule Participant in the Network Operator class where both the following are satisfied:

- (a) System Management informs the IMO that it has determined that it does not require information about the relevant network to maintain Power System Security and Power System Reliability; and
- (b) no Market Participant Registered Facilities are directly connected to the transmission system or distribution system.

2.28.4. A person who intends to own, control or operate a transmission system or distribution system which will form part of the South West Interconnected System, or will be electrically connected to that system, may register as a Rule Participant of the Network Operator class.

2.28.5. Subject to clause 2.28.16, a person registered as a Network Operator may be registered as a Rule Participant in another class or other classes.

2.28.6. Subject to clause 2.28.16, a person who owns, controls or operates a generation system which has a rated capacity that equals or exceeds 10 MW and is electrically connected to a transmission system or distribution system which forms part of the South West Interconnected System, or is electrically connected to that system, must register as a Rule Participant in the Market Generator class.

2.28.7. A person that owns, controls or operates a generation system which has a rated capacity of less than 10 MW, but which equals or exceeds 0.005 MW, and is electrically connected to a transmission system or distribution system which forms part of the South West Interconnected System, or is electrically connected to that system, may register as a Rule Participant in the Market Generator class.

Chapter 2

- 2.28.8. A person who intends to own, control or operate a generation system which has a rated capacity that equals or exceeds 0.005 MW and is or will be electrically connected to a transmission system or distribution system which forms part of the South West Interconnected System, or is electrically connected to that system, may register as a Rule Participant in the Market Generator class.
- 2.28.9. Subject to clause 2.28.16, a person registered as a Market Generator may be registered as a Rule Participant in another class or other classes.
- 2.28.10. Subject to clause 2.28.16, a person who sells electricity to Contestable Customers in respect of facilities electrically connected to a transmission system or distribution system which forms part of the South West Interconnected System, or is electrically connected to that system, must register as a Rule Participant in the Market Customer class.
- 2.28.11. A person who intends to sell electricity to Customers in respect of Facilities electrically connected to a transmission system or distribution system which forms part of the South West Interconnected System, or is electrically connected to that system, may register as a Rule Participant in the Market Customer class.
- 2.28.11A. A person who intends to enter into an Ancillary Service Contract with System Management and who is not registered in any other Rule Participant Class must register as an Ancillary Service Provider;
- 2.28.11B. A person who is registered in a Rule Participant Class other than the Ancillary Service Provider class, or who does not intend to enter into an Ancillary Service Contract with System Management may not register as an Ancillary Service Provider.
- 2.28.12. Subject to clause 2.28.16, a person registered as a Market Customer may be registered as a Rule Participant in another class or classes.
- 2.28.13. Subject to clause 2.28.16 and 4.24.4, a person not covered by clauses 2.28.2 to 2.28.12 but who sells or purchases electricity or another electricity related service under these Market Rules to or from the IMO must register as a Rule Participant. The person must register in either the Market Generator class or the Market Customer class, as determined by the IMO.
- 2.28.14. System Management is a Rule Participant, but is not required to register.
- 2.28.15. The IMO is a Rule Participant, but is not required to register, and must not be registered in any other Rule Participant class.
- 2.28.16. The IMO may determine that a person is exempted from the requirement to register in accordance with clauses 2.28.2, 2.28.6, 2.28.10, 2.28.11A or 2.28.13. An exemption may be given subject to any conditions the IMO considers appropriate.

Chapter 2

NEMMCO's practice has been to register one entity in respect of each facility, and exempt the other entities that fall in the "owns, controls or operates" net, but usually on condition that the exempted parties enter into a deed confirming that NEMMCO is entitled to deal with the registered entity in respect of the facility for all purposes under the Code. However, some participants, for their own purposes, have registered more than one entity in respect of a particular facility (eg, all the joint venturers owning a particular power station), and NEMMCO has facilitated this, particularly when the parties have made it clear they need to do it for tax or financing reasons.

2.28.17. A Rule Participant under these Market Rules is a participant for the purposes of section 121(2) of the Electricity Industry Act.

2.28.18. A Rule Participant that is registered as either a Market Generator or a Market Customer is a Market Participant.

2.28.19. A Rule Participant must:

- (a) be resident in, or have permanent establishment in, Australia;
- (b) not be an externally-administered body corporate (as defined in the Corporations Act), or under a similar form of administration under any laws applicable to it in any jurisdiction;
- (c) not have immunity from suit in respect of the obligations of a Rule Participant under these Market Rules; and
- (d) be capable of being sued in its own name in a court of Australia.

2.29. Facility Registration Classes

2.29.1. The following are Facilities for the purposes of these Market Rules:

- (a) a distribution system;
- (b) a transmission system;
- (c) a generation system; and
- (d) a connection point at which electricity is delivered from a distribution system or transmission system to a Rule Participant ("**Load**").

2.29.2. No facility registered in one Facility Class can simultaneously be registered in another Facility Class.

2.29.3. Subject to clause 2.29.9, a Network Operator must register any transmission system or distribution system owned, operated or controlled by that Network Operator as a Network, where that transmission or distribution system forms part of the South West Interconnected System, or is electrically connected to that system.

2.29.4. Subject to clause 2.29.9, a Market Generator that owns, operates or controls a generation system:

Chapter 2

- (a) must register that generation system as a Non-Scheduled Generator where the generation system has a rated capacity that equals or exceeds 0.005 MW and the generation system is an Intermittent Generator;
- (b) must register that generation system as a Scheduled Generator where the generation system has a rated capacity that equals or exceeds 10 MW and the generation system is not an Intermittent Generator;
- (c) subject to clause 2.29.6, may register that generation system as a Scheduled Generator where the generation system is not an Intermittent Generator and has a rated capacity that equals or exceeds 0.2 MW but which is less than 10 MW; and
- (d) must register that generation system as a Non-Scheduled Generator where the generation system has a rated capacity that equals or exceeds 0.005 MW and where the generation system is not otherwise required to be registered in accordance with (a) or (b) and where the option to register in accordance with (c), if applicable, is not exercised.

2.29.5. Subject to clause 2.29.9, a Market Customer that owns, operates or controls a Load:

- (a) may register that Load as an Interruptible Load if that Load has equipment installed to cause it to be interrupted in response to under frequency situations;
- (b) may register that Load as a Curtailable Load if that Load can be interrupted on request;
- (c) may register that Load as a Dispatchable Load if that Load:
 - i. is able to respond to instructions from System Management to increase or decrease consumption; and
 - ii. has a rated capacity of not less than 0.2 MW.

Dispatchable Loads are notionally loads that can behave like a generator. Note, however, that they are treated like Interruptible Loads and Curtailable Loads with respect to Reserve Capacity, since the natural obligation is that they keep their consumption below some level.

2.29.6. A Rule Participant must ensure that a Scheduled Generator registered by that Rule Participant is able to respond to instructions from System Management to increase or decrease output.

2.29.7. A Rule Participant must ensure a Non-Scheduled Generator registered by that Rule Participant is able to respond to instructions from System Management to decrease output.

Note that it may be appropriate to exempt small Non-Scheduled Generators from this requirement.

Chapter 2

2.29.8. A Rule Participant must ensure a Dispatchable Load registered by that Rule Participant is able to respond to instructions from System Management to increase or decrease consumption.

2.29.9. The IMO may determine that a person is exempted from the requirement to register a Facility in accordance with this clause 2.29. An exemption may be given subject to any conditions that IMO considers appropriate.

2.29.10 On request, the IMO must exempt a person from the requirement to register a generating system in accordance with this clause 2.29 if that generating system is identified by that person as supplying an Intermittent Load in accordance with clause 2.30B.2 and that generating system satisfies all the requirements of these Market Rules to serve Intermittent Load.

This exemption is an option that can be taken up by the person responsible for the generating system. However, if the option is taken up, the generating system will not be able to hold Capacity Credits and will not be able to participate in the energy market other than via its impact on the metered load. Thus there are reasons for such persons not to take up the option for this exemption.

2.29.11 With respect to the registration of a generation system to serve Intermittent Load, not more than one generation system may be registered for each Intermittent Load.

The aim of this clause is to avoid having two or more separate Scheduled Generators without their own meters being recorded by an Intermittent Load meter as it would be impossible to distinguish their output for settlement purposes. However this clause does not restrict several distinct generating units being aggregated as a single "generation system" for the purpose of registration.

2.30. Facility Aggregation

2.30.1. When registering facilities, a Rule Participant, or an applicant for rule participation, may apply to the IMO to allow the registration of two or more facilities as an aggregated facility.

2.30.2. Subject to clauses 2.30.5(a) to 2.30.5(c), Intermittent Generators operated by a single Market Participant that inject energy at a common network connection point and which, except for the operation of this clause 2.30.2, may be registered individually as Non-Scheduled Generators, must be aggregated as a single Non-Scheduled Generator.

This last clause precludes individual wind turbines being registered as individual facilities.

Chapter 2

- 2.30.3. Subject to clause 2.30.5, Curtailable Loads at different locations, but operated by a single Market Participant, may be aggregated with respect to their annual hours of availability so as cumulatively provide Reserve Capacity with an annual number of hours of availability greater than that of any of the individual facilities.
- 2.30.4. The IMO must consult with System Management when assessing an application for Facility aggregation and inform the relevant Rule Participant whether the aggregation of the facilities is allowed.
- 2.30.5. The IMO must only allow the aggregation of facilities if, in its opinion:
- (a) the aggregation will not adversely impact on System Management's ability to maintain power system Security and Reliability;
 - (b) adequate control and monitoring equipment exists for the aggregated Facility;
 - (c) none of the Facilities within the aggregated facility are subject to an Ancillary Service Contract or Network Control Service Contract that requires that Facility not be part of an aggregated facility; and
 - (d) with the exception of facilities aggregated under clause 2.30.3, the aggregated facilities are at the same location or have the same Loss Factor.
- 2.30.6. If the individual Facilities forming part of an aggregated facility have their own meters, and there is no single meter for the entire aggregated facility, then the settlement meter data for the aggregated facility must be the sum of the meter readings for its component facilities. An aggregated facility which has been registered as a Facility is taken to be treated as a single Facility for the purpose of these rules.
- 2.30.7. If the IMO approves the aggregation of Facilities then that aggregated facility must be registered as a single Facility for the purpose of these Market Rules .
- 2.30.8. Where the IMO considers, after consultation with System Management, that a change in one or more of the criteria in clause 2.30.5 means that an aggregated facility should no longer be aggregated, it must inform the relevant Rule Participant of the date on which the aggregated facility will be considered to have been disaggregated.
- 2.30.9. Except where clause 2.30.2 requires the aggregation of facilities, a Rule Participant with an aggregated facility may notify the IMO that it no longer wishes to operate the facility as an aggregated facility from a specified date.
- 2.30.10. Where an aggregated facility is disaggregated in accordance with clause 2.30.8 or 2.30.9:
- (a) each disaggregated facility is registered as a separate facility for the purpose of these Market Rules from the date specified by the IMO or the Rule Participant, as applicable; and

Chapter 2

- (b) the IMO may require the Rule Participant to provide Standing Data relevant to each disaggregated facility.

Note that updating data might involve tests.

2.30.11. The IMO must document the facility aggregation and disaggregation process in the Registration Procedure, and:

- (a) applicants for facility aggregation or disaggregation must follow that documented Market Procedure; and
- (b) the IMO and System Management must follow that documented Market Procedure when processing applications for facility aggregation and disaggregating previously aggregated facilities.

2.30A Exemption from Funding Spinning Reserve

2.30A.1. When registering an Intermittent Generator as a Non-Scheduled Generator, a Rule Participant, or an applicant for rule participation, may apply to the IMO for that Intermittent Generator to be exempted from funding Spinning Reserve cost.

2.30A.2 Where an application is received in accordance with clause 2.30A.1, the IMO must exempt the Intermittent Generator from funding Spinning Reserve costs where the applicant demonstrates to the satisfaction of the IMO that the shut down of the facility is a gradual process not exceeding a maximum ramp down rate equal to the installed capacity divided by 15MW/minute.

2.30A.3 The IMO must consult with System Management when assessing an application for exemption from funding Spinning Reserve costs.

2.30A.4 If the IMO approves the application for exempting an Intermittent Generator from funding Spinning Reserve costs then that facility must be excluded from the set of applicable facilities described in Appendix 2.

2.30A.5 Where the IMO considers, after consultation with System Management, that a change in the nature of an Intermittent Generator means that it should no longer be exempted from funding Spinning Reserve costs, it must:

- (a) inform the relevant Market Participant of the first Trading Month from which the facility will cease to be exempted; and
- (b) include that facility in the list of applicable facilities described in Appendix 2 from the commencement of that Trading Month.

2.30A.6 The IMO must document the Spinning Reserve costs exemption process in the Registration Procedure, and:

- (a) applicants for exemption from Spinning Reserve costs must follow that documented Market Procedure; and

Chapter 2

- (b) the IMO and System Management must follow that documented Market Procedure when processing applications for exemption from Spinning Reserve cost funding.

2.30B Intermittent Load

2.30B.1 An Intermittent Load is a Load that satisfies the requirements of clause 2.30B.2 and is recorded in Standing Data as being an Intermittent Load.

2.30B.2 For a Load to be eligible to be an Intermittent Load the following conditions must be satisfied:

- (a) a generation system must exist:
- i. which can typically supply the maximum amount of that Load to be treated as Intermittent Load either in accordance with clause 2.30B.11 or without requiring energy to be withdrawn from a Network. Where clause 2.30B.11 applies then, for the purpose of this clause (i), the amount that the generation system can supply must be Loss Factor adjusted from the connection point of the generation system to the connection point of the Intermittent Load;

A "Network" is a registered network. Connection assets etc that are not registered networks do not count.

- ii. the output of which is netted off consumption of the Load either in accordance with clause 2.30B.12 or by the meter registered to that Load; and
- iii. which would in the view of the IMO, if it were not serving an Intermittent Load, be eligible to hold an amount of Certified Reserve Capacity, determined in accordance with clause 2.30B.4, at least sufficient to supply the amount of energy that the generation system is required by (a)(i) to be able to supply while simultaneously being able to satisfy obligations on any Capacity Credits associated with that generation system;

This previous clause, in combination with clause 2.30B.4 means that if a generating system holds Capacity Credits (which requires it to be a registered generator) then the capacity available to serve that Intermittent Load is reduced by the amount of Capacity Credits held.

Note that for cases where the generating system is remote from the Intermittent Load the effective capacity of the generator must be determined by a process which does not consider losses, but the maximum energy it can supply the Intermittent Load must be loss adjusted. So, under clause (iii) to serve a 100 MW Intermittent Load, the generator must have at least 100 MW of capacity, but under clause (i) the amount of energy it must be able to provide (over an hour) might be more or less than 100 MWh depending on the Loss Factors.

Chapter 2

- (b) the Load shall reasonably be expected to have no net consumption of energy for at least 4320 Trading Intervals in any Capacity Year;

4320 Trading Intervals corresponds to 90 days.

- (c) the Market Customer for that Load must have an agreement in place with a Network Operator to allow energy to be supplied to the Load from a Network; and
- (d) the Load must be an Interruptible Load, Curtailable Load, or a Non-Dispatchable Load.

2.30B.3. The IMO must require that a Market Customer, or applicant to become a Market Customer, applying to register an Intermittent Load provide in regard to the generation system referred to in clause 2.30B.2(a):

- (a) the maximum capacity in MW, excluding capacity for which Capacity Credits are held, that generating system can be guaranteed to have available to supply Intermittent Load, when it is operated normally at an ambient temperature of 41°C;
- (aA) where clause 2.30B.11 applies, the connection point of the generation system,
 - (b) at the option of the applicant,
 - i. the anticipated reduction, measured in MW, in the maximum capacity described in (a) when the ambient temperature is 45°C;
 - ii. the method to be used to measure the ambient temperature at the site of the generating system for the purpose of determining Intermittent Load Refunds, where the method specified may be either:
 - 1. a publicly available daily maximum temperature at a location representative of the conditions at the site of the generating system as reported daily by a meteorological service; or
 - 2. a daily maximum temperature measured at the site of the generator by the SCADA system operated by System Management.

(Where no method is specified, a temperature of 41°C will be assumed); and

Assuming 41°C will be an attractive approach for generators with capacity that have no significant temperature dependency.

- (c) details of primary and any alternative fuels, including details and evidence of both firm and non-firm fuel supplies and the factors that determine restrictions on fuel availability that could prevent the generation system from operating at its full capacity;

Chapter 2

2.30B.4. The IMO must use the information provided by a Market Customer in accordance with clause 2.30B.3 to assess the additional Certified Reserve Capacity beyond the capacity required to meet Reserve Capacity Obligations on Capacity Credits actually held by the generation system referred to in clause 2.30B.2(a) that the IMO would normally assign to that generation system in accordance with Chapter 4 if:

- (a) the Intermittent Load did not exist; and
- (b) the generation system otherwise satisfied all requirements necessary to be treated as a Scheduled Generator entitled to hold Certified Reserve Capacity.

2.30B.5 A Market Customer, or applicant to become a Market Customer, may apply for a Load to be treated as an Intermittent Load as part of Market Customer registration (for a Non-Dispatchable Load) or Facility Registration (for an Interruptible Load or Curtailable Load).

2.30B.6 Subject to clause 2.30B.6A, the IMO must accept an application for a Load to be an Intermittent Load if the requirements of clause 2.30B.2 are satisfied.

The process itself by which the IMO does this is via processing registration and standing data changes.

2.30B.6A Where a Load referred to in clause 2.30B.6 is to be supplied by a generating system to which clause 2.30B.11 pertains, then the Load is to only be treated as an Intermittent Load from the first Trading Day in which both the Load and generating system are operating and until the commencement of the next Capacity Year.

2.30B.7. The IMO may cease to treat a Load as an Intermittent Load and require a Market Participant to modify its Standing Data in accordance with clause 2.34.11 from the commencement of a Trading Month if the IMO considers that the requirements of clause 2.30B.2 are no longer satisfied.

If a Load ceases to be an Intermittent Load then its requirement to fund Reserve Capacity will increase from the next Trading Month (as implied by the equations of Appendix 5).

2.30B.8. The IMO may consult with System Management in determining whether or not to accept, or continue to accept, a Load as satisfying the requirements of clause 2.30B.2.

2.30B.9. Where an Intermittent Load is transferred from one Market Customer to another all obligations to pay Intermittent Load Refunds calculated after the date of transfer in regard to that Intermittent Load, including those Intermittent Load Refunds arising from consumption that occurred prior to the date of transfer are to be automatically transferred.

Chapter 2

2.30B.10. For the purpose of defining Metered Schedules associated with the meter measuring an Intermittent Load, the following methodology is to apply:

(a) Define for each Trading Interval:

- i. Subject to clause 2.30B.12, NMQ to be the net metered energy measured by the meter where a positive amount indicates supply and a negative amount indicates consumption;
- ii. NS to be the net supply (supply less consumption) measured by the Intermittent Load meter which corresponds to supply and consumption, excluding consumption by Intermittent Loads, by Market Customers and Market Generator Facilities (excluding generation systems to which clause 2.30B.11 pertains) which are separately metered for the purpose of settlement under these Market Rules. This may have a positive or negative value;
- iii. NL to be the maximum possible consumption behind that meter due to consumption which is not Intermittent Load but which is measured only by the meter which also measures the Intermittent Load. This has a negative value;
- iv. MIL to be the maximum allowed Intermittent Load at the meter. This has a negative value;
- v. MSG to be the maximum energy output from a registered generating system (excluding generation systems to which clause 2.30B.11 pertains) measured only by the Intermittent Load meter where MSG equals the greater of zero and the maximum energy output of the facility based on Standing Data less the sum of MIL and NL. This has a positive value;
- vi. AMQ to be the adjusted meter quantity which equals the sum of NMQ and NS;

(b) if there is no registered generating system (excluding a generation system to which clause 2.30B.11 pertains) the output of which is measured only by the meter which also measures the Intermittent Load then:

- i. if AMQ is less than or equal to MIL then:
 1. for the purpose of defining its Metered Schedule the metered quantity associated with the Intermittent Load is MIL;
 2. for the purpose of defining its Metered Schedule the metered quantity associated with non-Intermittent Loads only measured by the Intermittent Load meter is $AMQ - MIL$;
- ii. if AMQ is greater than MIL then:
 1. for the purpose of defining its Metered Schedule the metered quantity associated with the Intermittent Load is AMQ;

- 2 for the purpose of defining its Metered Schedule the metered quantity associated with non-Intermittent Loads only measured by the Intermittent Load meter is zero;
- (c) if there is a registered generating system (excluding a generation system to which clause 2.30B.11 pertains) measured only by the meter that also measures the Intermittent Load then:
- i. if AMQ is less than or equal to MIL then:
 1. for the purpose of defining its Metered Schedule the metered quantity associated with the Intermittent Load is MIL;
 2. for the purpose of defining its Metered Schedule the metered quantity associated with non-Intermittent Loads measured only by the meter that also measures the Intermittent Load is $AMQ - MIL$;
 3. for the purpose of defining its Metered Schedule the metered quantity associated with the Scheduled Generator measured only by the meter that also measures the Intermittent Load is zero;
 - ii. if AMQ is greater than MIL but less than or equal to zero then:
 1. for the purpose of defining its Metered Schedule the metered quantity associated with the Intermittent Load is AMQ;
 2. for the purpose of defining its Metered Schedule the metered quantity associated with non-Intermittent Loads measured only by the meter that also measures the Intermittent Load is zero;
 3. for the purpose of defining its Metered Schedule the metered quantity associated with the Scheduled Generator measured only by the meter that also measures the Intermittent Load is zero;
 - iii. if AMQ is greater than zero but less than or equal to MSG then:
 1. for the purpose of defining its Metered Schedule the metered quantity associated with the Intermittent Load is zero;
 2. for the purpose of defining its Metered Schedule the metered quantity associated with non-Intermittent Loads measured only by the meter that also measures the Intermittent Load is zero;
 3. for the purpose of defining its Metered Schedule the metered quantity associated with the Scheduled Generator measured only by the meter that also measures the Intermittent Load is AMQ;
 - iv. if AMQ is greater than MSG then:

Chapter 2

1. for the purpose of defining its Metered Schedule the metered quantity associated with the Intermittent Load is $AMQ - MSG$;
2. for the purpose of defining its Metered Schedule the metered quantity associated with non-Intermittent Loads measured only by the meter that also measures the Intermittent Load is zero;
3. for the purpose of defining its Metered Schedule the metered quantity associated with the Scheduled Generator measured only by the meter that also measures the Intermittent Load is MSG .

Suppose the separately metered supply behind the Intermittent Load meter is 5 MWh and the separately metered consumption is -2 MWh. This means $NS=5-(-2) = +7$ MWh.

If the Intermittent Load has a maximum consumption of 15 MWh, normal load beyond the Intermittent Load has a maximum consumption of 20 MWh and there is a scheduled generator with the ability to generate 40 MWh then we have $MIL=-15$, $NL=-20$ and $MSG = \text{Max}(0, 40 - 15 - 20) = +5$.

If the meter reading is $NMQ = -27$ then $AMQ = -20$ and (c)(i) implies that for settlement purposes the Intermittent Load is -15, the non-Intermittent Load is -5 and the Scheduled Generator has an output of 0. Because there are penalties on exceeding Intermittent Load it is necessary to assume that meter load is Intermittent Load before allocating it to normal load.

If the meter reading is $NMQ = -17$ then $AMQ = -10$ and (c)(ii) implies that for settlement purposes the Intermittent Load is -10, the non-Intermittent Load is 0 and the Scheduled Generator has an output of 0.

If the meter reading is $NMQ = -3$ then $AMQ = +4$ and (c)(iii) implies that for settlement purposes the Intermittent Load is 0, the non-Intermittent Load is 0, and the Scheduled Generator has an output of 4.

If the meter reading is $NMQ = +5$ then $AMQ = +12$ and (c)(iv) implies that for settlement purposes the Intermittent Load is +7, non-Intermittent Load is 0, the Scheduled Generator has an output of 5. Note that if there were no Scheduled Generator (only unregistered generators) then Intermittent Load would be 12 in this case. This would be settled at MCAP rather than at the prices applicable to a Scheduled Generator.

2.30B.11. The generation system described in clause 2.30B.2(a) is deemed to satisfy the requirements of clause 2.30B.2(a)(i) if it is located at a different connection point to that of the Load to which clause 2.30B.2 pertains and all of the following conditions are satisfied prior to the Load commencing to be an Intermittent Load:

- (a) the generation system must be a registered Facility;

- (b) the Load to which clause 2.30B.2 pertains must have a nominated maximum consumption quantity specified in its Standing Data of not less than 40 MWh;
- (c) the output of the generation system must be measured an interval meter registered with a Metering Data Agent;
- (d) the generation system must have no Capacity Credits associated with it for the Capacity Year during which it is expect to commence operation;
- (f) the generation system must be constructed with the intention of serving the Intermittent Load;
- (g) the generation system must not be part of an Aggregate Facility with other generation systems; and
- (h) the IMO was notified of the use of such a generation system to serve the Intermittent Load in accordance with clause 4.5.3A(b)(iii) prior to the registration of that Intermittent Load;

2.30B.12. Where a generation system described in clause 2.30B.2(a) satisfies the requirements of clause 2.30B.11 and is associated with an Intermittent Load then the interval meter associated with that generation system is not to be included in settlement processes with the exception that:

- (a) for the purpose of clause 2.30B.10(a)(i), the net metered energy for a Trading Interval measured by the Intermittent Load meter and used in defining NMQ is to be reduced by the metered output for the corresponding Trading Interval of the generation system Loss Factor adjusted from the connection point of the generation system to connection point of the Intermittent Load; and
- (b) the meter data for the generation system is to be used in determining the applicable capacity associated with that generation system as required by Appendix 2.

2.30B.13. Where a generation system described in clause 2.30B.2(a) satisfies the requirements of clause 2.30B.11 and is associated with an Intermittent Load then that generation system is to be deemed to be at the location of the Intermittent Load with respect to its inclusion in Bilateral Submissions, STEM Submissions and Resource Plans.

2.30C.Rule Commencement and Registration Data

The purpose of this section is to provide some over-arching principles for the registration process to describe how changes in registration requirements, or changes in how participants want to be registered, are handled.

2.30C.1. The IMO must not require that an applicant for Rule Participant registration or Facility Registration provide information on any application form, or evidence to support that application form, pertaining to registration if the applicable Market Rules requiring that information to be provided have not commenced.

Chapter 2

2.30C.2. Prior to the Appointed Day, the IMO may delay the requirement for a person to pay fees related to Rule Participant registration or Facility Registration until the Appointed Day.

The Appointed Day is a date to be announced by the Minister on which the regulation requirements to be registered take effect.

2.30C.3. Where a rule is to commence after the Appointed Day which requires additional or revised Standing Data to be maintained, the IMO must notify Rule Participants of:

- (a) the additional or changed Standing Data required, and
- (b) the time and date by which the additional or changed Standing Data must be provided and accepted;

where the IMO must set the time and date in (b) to allow Market Participants sufficient time to provide the requested data and for it to be accepted prior to the rule commencing.

2.30C.4. Where the IMO issues a notice in accordance with clause 2.30C.3, Rule Participants must provide the additional Standing Data requested by the time and date specified in that notice.

Note that any participant that fails to satisfy this clause will be in breach of the market rules and could be fined or, in the extreme case, could be suspended by the Energy Review Board.

2.31. Registration Process

2.31.1. The IMO must maintain the following Registration Forms on the Market Web Site:

- (a) the Rule Participant registration form;
- (b) the Rule Participant de-registration form;
- (c) the Facility registration form;
- (d) the Facility de-registration form; and
- (e) the Facility transfer form.

2.31.2. Any person wishing to register or de-register as a Rule Participant in one or more classes, or to register, de-register, or transfer a Facility, must complete the applicable form and submit that form, supporting information and any applicable Application Fees to the IMO.

2.31.3. The IMO must notify an applicant of the receipt of the application within one Business Day of receipt of an application form described in clause 2.31.2.

Chapter 2

2.31.4. Subject to clause 2.30C.1, the IMO may, at its discretion, require that an applicant provide information that is missing from the relevant application form, or is inadequately specified. The date at which the requested information is submitted to the IMO in full is to become the date of receipt of the application for the purpose of clause 2.31.3.

Clause 2.30C.1 states that the IMO must ignore information required by clauses that are not yet active because the IMO may not have a process in place for dealing with that information and may not have defined precisely the form of data to be provided.

2.31.5. The IMO:

- (a) must consult with System Management with respect to applications for Facility registration, de-registration or transfer; and
- (b) may consult with relevant Network Operators with respect to applications, registration, de-registration or transfer of generating works or Loads.

This clause would see the IMO conferring with System Management and cross-checking facility data against data held by Network Operators as a result of access agreements. This would include using data from tests required under Access so as to avoid needlessly repeating tests.

2.31.6. In the case of an application for Facility registration, the IMO must notify an applicant within 15 Business Days from the date of notification of receipt of:

- (a) the dates on which any tests required by these Market Rules that must be conducted prior to a facility registration may be held;
- (b) the date by when results of tests referred to in (a) must be made available to the IMO; and
- (c) the date by when the IMO plans to accept or reject the application, being no later than 10 Business Days after the date in (b).

2.31.7. When a test is required under the Market Rules prior to the registration of a Facility, the IMO may determine that the test is not necessary and in doing so must take into consideration any previous tests performed in connection with an Arrangement for Access.

2.31.8. System Management must allow a facility holding an Arrangement for Access to operate for the purpose of tests required under the Arrangement for Access, provided that the carrying out of these tests have received approval from System Management.

2.31.9. The relevant Network Operator must cooperate with any tests required by these Market Rules that must be conducted prior to the registration of a Facility.

Chapter 2

This would only be for any tests required for data that is not already available as a result of Access requirements. Data which has been tested under the Access regime would be confirmed by the IMO conferring with the Network Operator under clause 2.31.5.

2.31.10. The IMO must determine whether to accept or reject the application and notify an applicant accordingly:

- (a) by the date specified in accordance with clause 2.31.6(c) in the case of an application for Facility registration;
- (b) within 20 Business Days after the date of notification of receipt in the case of an application for Rule Participant registration in the Market Generator or Market Customer class; and

This longer period is to enable assessment of prudential information. Note also that if the applicant is also registering facilities then the facility registration could take longer than the thirty days in accordance with (a).

- (c) within five Business Days from the date of notification of receipt in the case of other applications.

2.31.11. Where the IMO has accepted the application the notification must include:

- (a) in the case of an application to register as a Rule Participant in one or more classes, the date and time that registration is to take effect where the date is to be the later of the earliest date by which the IMO can facilitate the registration and the date specified in accordance with clause 2.33.1(k);
- (b) in the case of an application to de-register as a Rule Participant in one or more classes
 - i. where the Rule Participant is a Market Generator or Market Customer, the date and time on which the Rule Participant must cease trading as a Market Generator or Market Customer, being the start of the Trading Day beginning on the date specified in accordance with clause 2.33.2(d); and
 - ii. a statement that de-registration as a Rule Participant will not take effect until the requirements of clause 2.31.16 are satisfied;
- (c) in the case of an application to register a Facility, the date and time that registration is to take effect where the date is to be the later of the earliest date by which the IMO can facilitate the registration and the date specified in accordance with clause 2.33.3(c)(xii);
- (d) in the case of an application to de-register a Facility, the date and time that de-registration is to take effect where the date is to be the later of the earliest date by which the IMO can facilitate the de-registration and the date specified in accordance with clause 2.33.4(d); and

Chapter 2

- (e) in the case of an application to transfer a Facility, the date and time that transfer is to take effect where the date is to be the later of the earliest date by which the IMO can facilitate the transfer and the date specified in accordance with clause 2.33.5(e)(iii).

2.31.12. Where IMO has rejected the application the notification must include the reason for its rejection of the application.

2.31.13. The IMO may only reject an application if:

- (a) subject to clause 2.30C.1, the application form, when read together with any information received after a request under clause 2.31.4, is incomplete or provides insufficient detail;
- (b) subject to clause 2.30C.1, required supporting evidence is insufficient or not provided;
- (c) the required Application Fee is not paid;
- (d) the IMO is not satisfied that the applicant can comply with the requirements for Rule Participation or Facility registration;
- (e) in the case of an application to register as a Rule Participant in any class where the person has previously been de-registered as a Rule Participant following an order from the Energy Review Board, the IMO is not satisfied that person has remedied the reason for or underlying cause of the prior de-registration;
- (f) in the case of an application to de-register as a Market Generator, the applicant has not arranged to de-register its Registered Facilities that are generating works or transfer those Registered Facilities to another Rule Participant prior to the proposed date of de-registration as a Market Generator;
- (g) in the case of an application to de-register as a Market Customer, the applicant has not arranged to de-register its Registered Facilities that are Loads or transfer those Registered Facilities to another Rule Participant prior to the proposed date of de-registration as a Market Customer;
- (h) in the case of an application to de-register as a Network Operator, the applicant has not arranged to de-register its Registered Facilities that are Networks or transfer those Registered Facilities to another Rule Participant prior to the proposed date of de-registration as a Network Operator;
- (i) in the case of an application to register a Facility, the applicant fails to conduct tests in accordance with clause 2.31.6, fails those tests, or fails to provide adequate information about the tests;
- (j) in the case of an application to register a Facility, the relevant Metering Data Agent informs the IMO that the facility is not registered in its Meter Registry or

Chapter 2

that the Meter Registry information is not consistent with the information in the application to register the facility; or

- (k) in the case of an application to de-register a Facility if the Market Participant holds Capacity Credits for the Facility.

2.31.14. A person who has an application to become a Rule Participant approved for one or more Rule Participant classes, is to become a Rule Participant in the approved class or classes from the date and time specified in accordance with clause 2.31.11(a).

2.31.15. A person who has an application for de-registration from being a Market Generator or Market Customer, accepted must cease trading as a Market Generator or Market Customer, as applicable, by the date for ceasing trade specified in clause 2.31.11(b)(i).

2.31.16. Where an application for de-registration from a Rule Participant class has been accepted by the IMO, participation in the Rule Participant class cease from the end of the first Business Day in which the Rule Participant:

- (a) has de-registered all of its Facilities applicable to the class;
- (b) has resolved and settled all outstanding disputes, investigations and enforcement actions;
- (c) has paid all outstanding debts to the IMO; and
- (d) has received final payment of all amounts owed to it by the IMO.

2.31.17. The fact that a person has ceased to be registered in any Rule Participant class does not affect any right, obligation or liability of that person under these Market Rules which arose prior to the cessation of its registration.

2.31.18. If the IMO accepts a facility registration then that Facility becomes a Registered Facility of the applicant from the date and time specified in accordance with clause 2.31.11(c).

2.31.19. If the IMO accepts a facility deregistration then that Facility ceases being a Registered Facility of the applicant from the date and time specified in accordance with clause 2.31.11(d).

2.31.20. If the IMO accepts a Facility transfer then from the date and time specified in accordance with clause 2.31.11(e):

- (a) each Facility covered by the transfer will cease to be a Registered Facility of the Rule Participant to whom it was registered prior to the transfer; and
- (b) each Facility covered by the transfer will become a Registered Facility of the Rule Participant who submitted the application.

Chapter 2

- 2.31.21. The IMO must maintain a register of:
- (a) Rule Participants
 - (b) Registered Facilities.
- 2.31.22. For the purpose of this clause 2.31:
- (a) the IMO must only indicate that it can facilitate participation in a Rule Participant class or Facility Class from the time that the IMO has established that System Management can facilitate such participation; and
 - (b) System Management must facilitate participation in a Rule Participant class or Facility Class by an approved applicant as soon as practicable.
- 2.31.23. The IMO must document the registration, de-registration and transfer process in the Registration Procedure, and:
- (a) applicants to register or de-register as a Rule Participant in a particular class must follow the documented Market Procedure applicable to that class;
 - (b) applicants to register, de-register, or transfer a Facility in a particular Facility Class must follow the documented Market Procedure applicable to that class;
 - (c) System Management must provide the IMO with all assistance required of it under these Market Rules and in accordance with the documented Market Procedure; and
 - (d) the IMO must follow that documented Market Procedure when processing applications for Rule Participant registration or de-registration, or for registration, de-registration or transfer of a facility.
- 2.31.24. A person who is a Rule Participant registered in a particular class and wishes to be registered in another class must apply for registration as a Rule Participant in that class under this clause 2.31.

2.32. Rule Participant Suspension and Deregistration

- 2.32.1. Where the IMO receives notice that the Energy Review Board has made a decision in accordance with the Regulations that a Rule Participant be suspended, the IMO must issue a Suspension Notice to the Rule Participant.

Suspension can also occur in the event of default – see clause 9.23.
--

- 2.32.2. The IMO must copy any Suspension Notice to all Rule Participants and must inform all Rule Participants when a Suspension Notice is withdrawn.
- 2.32.3 The IMO may specify in a Suspension Notice directions that the relevant Rule Participant must comply with to give effect to the suspension.
- 2.32.4. From the time the IMO issues a Suspension Notice to a Rule Participant:

Chapter 2

- (a) the Rule Participant must comply with the Suspension Notice, including:
 - i. trading or ceasing trading in the Wholesale Electricity Market to the extent specified in the notice; and
 - ii. continuing to meet any existing Reserve Capacity Obligations specified in the notice.
- (b) the IMO may do all or any of the following to give effect to the notice:
 - i. reject any Submissions from, or on behalf of, the Market Participant, and cancel any existing Submissions; and
 - ii. withhold payments owed to a defaulting Rule Participant.

2.32.5. The IMO must withdraw a Suspension Notice where:

- (a) if the notice was issued under clause 9.23, the defaulting Rule Participant has remedied the relevant suspension event and is complying with its Prudential Obligations; and
- (b) if the notice was issued under clause 2.32.1, it receives a further notice that the Energy Review Board has withdrawn the suspension,

and no other circumstances exist that would entitle the IMO to issue a Suspension Notice.

2.32.6. Where a Rule Participant has been suspended for 90 days, the IMO may apply to the Energy Review Board for a de-registration order in accordance with the Regulations.

2.32.7. Where the IMO receives notice that the Energy Review Board has made a decision in accordance with the Regulations that a Rule Participant be de-registered, the relevant Rule Participant ceases to be a Rule Participant from the time specified in the notice. The IMO must de-register all of the Facilities registered by the Rule Participant by the time specified in the notice.

2.32.8. The de-registration of a Rule Participant does not affect any rights, obligations or liabilities arising under or in connection with these Market Rules prior to the time the Rule Participant ceases to be a Rule Participant.

2.32.9. The IMO may require a Network Operator to disconnect one or more of the Facilities registered by a suspended or deregistered Rule Participant in order to give effect to a Suspension Notice or deregistration. If the IMO gives a notice under this clause to a Network Operator, then the Network Operator must comply with the notice as soon as practicable. If the disconnection arises because of the suspension of a Market Participant and the Suspension Notice is subsequently withdrawn by the IMO under clause 2.32.5, then the IMO must request the relevant Network Operator to reconnect the Facilities registered by the relevant Rule Participant.

This reflects clauses 5.9.3 to and 5.9.6 of the National Electricity Code. If a Market Participant has been suspended and its registered loads are still connected, then the market is exposed. The “retailer of last resort” scheme will operate separately.

2.33. The Registration Forms

2.33.1. The Rule Participant registration form prescribed by IMO must require that an applicant for registration as a Rule Participant provide the following:

- (a) the relevant non-refundable Application Fee;
- (b) whether the applicant is already a Rule Participant in other classes;
- (c) contact details for the applicant;
- (d) invoicing details for the applicant;
- (e) tax information from the applicant required by law;
- (f) the class or classes of Rule Participant to which the application relates;
- (g) [Blank]
- (h) if the application relates to the Market Customer class
 - i. evidence that the applicant holds an Arrangement for Access for the purpose of taking power from the electricity grid; and
 - ii. the information described in Appendix 1(f);
- (i) confirmation of the implementation of any processes or systems required by these Market Rules for each Rule Participant class to which the application relates;
- (j) information on any Facility registration applications that will follow successful Rule Participant registration or are required as a condition of Rule Participant registration;
- (k) a proposed date for becoming a Rule Participant for each Rule Participation class to which the application relates;
- (l) information required for the IMO to determine the applicant’s required Credit Limit;
- (m) such other information as the IMO considers it requires to process the application;
- (n) an undertaking that the Rule Participant agrees to comply with its obligations as set out in these Market Rules; and
- (o) a statement that the information provided is accurate.

2.33.2. The Rule Participant de-registration form prescribed by IMO must require that a Rule Participant provide the following:

- (a) the relevant non-refundable Application Fee;

Chapter 2

- (b) the identity of the Rule Participant;
- (c) the classes of Rule Participation to which the application relates;
- (d) a proposed date for ceasing operation in each Rule Participant class covered by the application, where that date must be not earlier than 10 Business Days after the date of application;
- (e) such other information as the IMO considers it requires to process the application; and
- (f) a statement that the information provided is accurate.

The 10 Business Day limit assures that the request can be processed in time. Note that the applicant does not cease to be a Rule Participant from that date, but simply ceases trading.

Note that if a Rule Participant sells a generator to another Rule Participant, then the transfer of the generator would be addressed via facility transfer rules.

2.33.3. The Facility Registration form prescribed by IMO must require that an applicant for facility registration provide the following:

- (a) the relevant non-refundable Application Fee where this Application Fee may differ for different facility classes;
- (b) the identity of the party making the application, where that party must be a Rule Participant or be in the process of applying to be a Rule Participant;
- (c) for each Facility to be registered:
 - i. the name of the Facility;
 - ii. the owner of the Facility;
 - iii. the class of Facility;
 - iv. the location of the Facility;
 - v. if the Facility is aggregated or not and details of any proposed aggregation;
 - vi. contact details for the Facility;
 - vii. if the Facility is yet to commence operation:
 - 1. a proposed date for commencing commissioning the Facility; and
 - 2. a commissioning plan for the Facility.
 - viii. evidence that an Arrangement for Access is in place, if necessary;
 - ix. details of operational control over that Facility;
 - x. applicable Standing Data as required by Appendix 1;

Chapter 2

- xi. information on the communication systems that exist for operational control of the Facility; and
- xii. a date for commencement of operation; and
- (d) a statement that the information provided is accurate.

2.33.4. The Facility de-registration form prescribed by IMO must require that the applicant provide the following:

- (a) the relevant non-refundable Application Fee;
- (b) identification of the Registered Facility to which the application relates;
- (c) Information as to whether the Registered Facility is being:
 - i. decommissioned; or
 - ii. moth-balled or placed in reserve shut-down, in which case information on the time required to return the Registered Facility to service should be included;
- (d) a proposed date on which that Registered Facility is to cease to be registered in the name of that Rule Participant where that date must be:
 - i. not earlier than six months after the date of application if the Facility will cease operation; or
 - ii. the date the application is accepted in the event that the Facility has been rendered permanently inoperable; and
- (e) such other information as the IMO considers it requires to process the application; and
- (f) a statement that the information provided is accurate.

In reality, System Management is likely to be well aware of the decommissioning date months to years in advance of this happening due to its medium term planning and the IMO's long term planning. However, clause (e) is required to make sure there is no uncertainty.

2.33.5. The Facility transfer form prescribed by IMO must require that an applicant for transfer of a Facility provide the following:

- (a) the relevant non-refundable Application Fee;
- (b) the identity of the party making the application, where that party must be a Rule Participant or be in the process of applying to be a Rule Participant;
- (c) the name of the Rule Participant in respect of which the Facility is currently registered;
- (d) evidence that the Rule Participant identified in (c) consents to the transfer;
- (e) for each facility to be transferred:

Chapter 2

- i. the name of the Facility;
- ii. the owner of the Facility;
- iii. a proposed date for the transfer to take affect;
- iv. evidence that any required Arrangement for Access is in place; and

This could include transfer to the new owner.

- v. details of operational control over that facility; and
- (f) evidence to the satisfaction of IMO that the party making the application has assumed the Reserve Capacity Obligations associated with the Facility, and agrees to any Short Term Special Price Arrangements or Long Term Special Price Arrangements associated with the Facility;
- (g) such other information as the IMO considers it requires to process the application; and
- (h) a statement that the information provided is accurate.

2.34. Standing Data

2.34.1. The IMO must:

- (a) maintain a record of the Standing Data described in Appendix 1, including the date from which the data applies; and
- (b) provide the Standing Data and any revisions of the Standing Data to System Management as soon as practicable.

2.34.2. Each Rule Participant must ensure that Standing Data required by the Market Rules to be provided to the IMO for that Rule Participant is and remains accurate.

2.34.2A. A Rule Participant must, as soon as practical, seek to have its Standing Data revised, other than Standing Data described in clause 2.34.2B, if it becomes aware that its Standing Data is currently inaccurate or not in compliance with the requirements of these Market Rules, or will become inaccurate or will cease to be in compliance with the requirements of these Market Rules within the next 5 Business Days.

2.34.2B A Rule Participant may seek to have the following Standing Data changed at any time:

- (a) price or payment related data;
- (b) whether a Load not currently treated as an Intermittent Load is treated as an Intermittent Load, provided that the Rule Participant is confident that the Load satisfies the requirements of clause 2.30B.2 and provided that the Rule Participant complies with clause 4.28.8A; and

Chapter 2

- (c) whether a Load currently treated as an Intermittent Load is to cease to be treated as an Intermittent Load.

2.34.3. A Rule Participant that seeks to change its Standing Data, other than Standing Data changed in accordance with the processes set out in clauses 6.3C or 6.5B, must notify the IMO of:

- (a) the revisions it proposes be made to its Standing Data;
- (b) the reason for the change; and
- (c) the date and time from which the revision will take effect.

2.34.4. Notwithstanding clauses 2.34.2 and 2.34.3, a Rule Participant is not required to notify the IMO of changes to Standing Data where the changes reflect a temporary change in the capability of a Registered Facility resulting from a Planned Outage, Forced Outage or Consequential Outage.

2.34.5. The IMO must confirm receipt of the notification described in clause 2.34.3 within one Business Day of receipt of notification.

2.34.6. The IMO may, at its discretion, request further information from a Rule Participant, including requiring that tests be conducted and evidence provided, concerning a notification of a change in Standing Data described in clause 2.34.3. A Rule Participant must comply with a request under this clause.

2.34.7. The IMO may reject a change:

- (a) in Standing Data related to prices and payments
 - i. if the price or payment data submitted is inconsistent with any applicable limit on those values under these Market Rules; or
 - ii. if the IMO is not satisfied with evidence provided that the submitted data represents the reasonable costs of the Market Participant in the circumstances related to that price or payment; and
- (b) in any other Standing Data if it considers that an inadequate explanation, including tests results, is provided to justify the change in Standing Data.

2.34.8. Other than Standing Data changed in accordance with the processes set out in clauses 6.2A, 6.3C or 6.5C, the IMO must notify the Rule Participant of its acceptance or rejection of the change in Standing Data as soon as practical, and no later than three Business Days after the later of:

- (a) the date of notification described in clause 2.34.3; and
- (b) if IMO makes a request under clause 2.34.6, the date on which the information requested is received by the IMO.

Chapter 2

2.34.9. If the IMO rejects a change in Standing Data it must provide the Rule Participant that requested the change with its reasons for rejecting the change.

2.34.10. Where System Management becomes aware that a Rule Participant's Standing Data is currently inaccurate, or will become inaccurate as of a date in the future, it must, as soon as practical, notify the IMO of the item that it considers to be inaccurate or which will become inaccurate, as the case may be.

2.34.11. The IMO may require that a Rule Participant provide updated Standing Data for any of its Registered Facilities if the IMO considers the information provided by the Rule Participant to be inaccurate or no longer accurate.

2.34.12. The IMO must consult with System Management before making a decision requiring a Rule Participant to provide updated Standing Data under clause 2.34.11.

2.34.13. If the IMO requires a Rule Participant to provide updated Standing Data under clause 2.34.11, then:

- (a) The Rule Participant must provide the IMO with updated Standing Data for the specified Registered Facility as soon as practicable; and
- (b) where the Rule Participant fails to provide updated Standing Data in a timely manner, the IMO may temporarily substitute data restricting the capability of the Facility until such time as the Rule Participant updates the Standing Data. The IMO must notify the Rule Participant when it is using such substitute data.

2.34.14 The IMO must commence using revised Standing Data from:

(a) 8:00 AM on the Scheduling Day following the IMO's acceptance of the revised Standing Data in the case of:

i. Standing STEM Submissions;

iA. Standing Bilateral Submissions;

iB. Standing Resource Plan Submissions;

ii. commitment and decommitment cost data and Standing Balancing Data; and

iii. Standing Data changes stemming from acceptance of an application under clause 6.6.9;

with the exception that the previous Standing Data remains current for the purpose of settling the Trading Day that commences at the same time as that Scheduling Day; and

Clause 6.6.9 refers to applications to have a non-dual fuelled generator deemed dual-fuelled for the energy market. The condition about settlement of the Trading Day that commences

Chapter 2

at the same time as that Scheduling Day is required because the old Standing Data will still apply for the settlement of that Trading Day as that old data was used in scheduling that day.

(b) as soon as practicable in the case of any other revised Standing Data.

2.34.15. System Management must commence using the Standing Data or revised Standing Data, as soon as it is received from the IMO.

Communications and Systems Requirements

2.35. Dispatch Systems Requirements

2.35.1. Market Participants with Scheduled Generators, Non-Scheduled Generators, Dispatchable Loads, and Curtailable Loads that are not under the direct control of System Management must maintain communication systems that enable communication with System Management for dispatch of those Registered Facilities.

2.35.2. Market Participants with Registered Facilities to which clause 7.8.1 relates must provide the necessary communication systems for System Management to activate and control the level of output of the Registered Facility as required for it to comply with Dispatch Instructions.

This relates to facilities under the direct control of System Management.

2.35.3. The Rule Participant in respect of an Interruptible Load must maintain systems to reduce the energy consumption of the Interruptible Load in response to system frequency changes.

2.35.4. System Management must document the communications and control system requirements necessary to support the dispatch process described in these Market Rules in the Power System Operation Procedure. System Management, Market Participants and Network Operators must comply with that documented Market Procedure in respect of communication and control system requirements.

2.36. Market Systems Requirements

2.36.1. Where the IMO uses software systems in the Reserve Capacity Auction, STEM Auction or settlement processes, it must:

- (a) maintain a record of which version of software was used in producing each set of results, and maintain records of the details of the differences between each version and the reasons for the changes between versions;
- (b) maintain each version of the software in a state where results produced with that version can be reproduced for a period of at least 1 year from the release date of the last results produced with that version;

Chapter 2

Ideally, all versions of market software would be maintained for a significant period of time so that all market cases could be re-examined in response to disputes. The practical difficulty is that it can be quite expensive to maintain old software in operating condition because of the need to maintain licenses for earlier versions of software.

- (c) ensure that appropriate testing of new software versions is conducted;
- (d) ensure that any versions of the software used by the IMO have been certified as being in compliance with the Market Rules by an independent auditor;
- (e) require vendors of software audited in accordance with clause (d) to make available to Rule Participants explicit documentation of the functionality of the software adequate for the purpose of audit.

The aim of this point is to ensure that contracts are written so that Vendors cannot refuse to provide documentation. In the NEM the vendor is required to prepare a document describing in mathematical terms how it implements each feature of the design. Alternatively, in New Zealand, the market develops the document and audits vendor software relative to that document.

Whatever approach is used, the Market Participants should have transparency as to what goes on inside the scheduling software.

2.36.2. A “version” of the software referred to in clause 2.36.1 means any initial software used and any changes to the software that could have a material effect on the prices or quantities resulting from the use of the software.

2.36.3. A Market Participant must ensure that any of its systems which are linked to the IMO’s systems must conform to the IMO’s data and IT security standards at the point of interface.

2.36.4. No Market Participant is to deliberately use systems in manner that will undermine the operability of those or connected software systems.

2.36.5. The IMO must document the data and IT interface requirements, including security standards required for Market Participants to operate in the Wholesale Electricity Market in the relevant procedure to which the system pertains and the IMO and Market Participants must comply with that documented Market Procedure in respect of data and IT interface requirements.

Prudential Requirements

It is not apparent that there need be any Prudential Requirements for the IMO or System Management.

2.37. Credit Limit

2.37.1. The IMO must determine a Credit Limit for each Market Participants.

Chapter 2

2.37.2. The IMO may revise the Credit Limit of a Market Participant at any time.

2.37.3. The IMO must review the Credit Limit of a Market Participant at least once each year.

2.37.4. The Credit Limit for each Market Participant is the dollar amount determined by the IMO as being equal to the maximum net amount that the Market Participant is expected to owe the IMO over any 70 day period where this amount is not expected to be exceeded more than once in a 48 month period. When determining the Credit Limit for a Market Participant the IMO must take into account:

The 70 day limit is based on the maximum time between a Trading Day occurring and settlement of that Trading Day. This allows for about 30 Trading Days included in a settlement cycle, an additional 30 days to secure meter data pertaining to all Trading Days in that period and about 10 days for settlement. The precise length of this period may need to be revised as the rules mature.

- (a) the average level and volatility of the MCAP and the STEM Clearing Price for the previous 48 months, or such shorter time period as data is available for;
- (b) the metered quantity data for the Market Participant, or an estimate of their expected generation and consumption where no meter data is available;
- (c) the correlation between the metered amounts of electricity and MCAP;
- (d) the length of the settlement cycle and the process set out in clauses 9.23, 9.24 and 2.32;
- (e) a reduction in the Credit Limit reflecting applicable bilateral contract purchase quantities, where these quantities are the historical bilateral contract submissions, or an estimate of the Market Participant's expected bilateral contract levels where no historical bilateral contract submission data is available;
- (f) the historical STEM sales and purchases, or an estimate of the Market Participant's expected STEM sales and purchases where no historical STEM sale and purchase data is available;
- (g) the expected level of ancillary service payments;
- (h) the statistical distribution of the accrued amounts that may be owed to the IMO;
- (i) the degree of confidence that the Credit Limit will be large enough to meet large defaults; and
- (j) any past breach of the Regulations or these Market Rules by, the Market Participant or a related entity of the Market Participant.

One issue for our market is that a much smaller percentage of electricity is expected to be traded via the market settlement process – a large percentage will be traded via bilaterals. Hence it is always possible that a retailer might suddenly have no bilateral contracts, and

Chapter 2

start to purchase all of its energy from the market. However, if we set the credit limit on this worst case scenario the level of credit support required would likely be excessive. So the Credit Limit calculation does take into account historical bilateral levels for the participant.

2.37.5. A Market Participant must notify the IMO as soon as practical where it considers that:

- (a) its metered consumption quantities in a Trading Month will significantly exceed the amount assumed in the last calculation of its Credit Limit; or
- (b) its quantity of electricity purchased bilaterally in a Trading Month will be significantly lower than assumed in the last calculation of its Credit Limit.

2.37.6. The IMO must determine a Credit Limit for each Network Operator that is required under these Market Rules to fund a Network Control Service Contract, where this Credit Limit is the dollar amount determined by the IMO as being equal to maximum possible amount payable over a 70 day period under the Network Control Service Contracts relating to the Network Operator.

In effect, it is the value of the contract payment assuming no Reserve Capacity revenue for the generator.

2.37.7. The IMO must review the Network Operator's Credit Limit when a Network Control Services Contract relating to the Network Operator commences or terminates.

2.37.8. The IMO must notify each Market Participant and each Network Operator required to fund a Network **Control** Service Contract of their Credit Limit, and provide details of the basis for the determination of the Credit Limit.

2.37.9. The IMO must develop guidelines in the Market Procedure referred to in clause 2.43 for determining the expected value of a transaction. The guidelines must be consistent with the methodology that the IMO uses to determine Credit Limits for Market Participants.

2.38. Credit Support

2.38.1. Where at any time a Market Participant, or Network Operator that is required to fund a Network **Control** Service Contract, does not meet the Acceptable Credit Criteria set out in clause 2.38.6, then the Market Participant, or Network Operator required to fund a Network **Control** Service Contract, must ensure that the IMO holds the benefit of Credit Support in an amount not less than its Credit Limit.

2.38.2. Where a Market Participant's or a Network Operator's existing Credit Support is due to expire or terminate, then that Market Participant or Network Operator must, at least 10 Business Days before the time when the existing Credit Support will expire or terminate, ensure that the IMO holds the benefit of a replacement Credit Support in an amount not less than the level required under clause 2.38.1 that will become effective at the expiry of the existing Credit Support.

Chapter 2

2.38.3. Where a Market Participant's or a Network Operator's Credit Limit is increased, or where the existing Credit Support is no longer current or valid (for example, because the credit support provider ceases to meet the Acceptable Credit Criteria) or where some or all of the Credit Support has been drawn on by the IMO in accordance with these Market Rules, then that Market Participant or Network Operator must ensure that the IMO holds the benefit of a replacement Credit Support in an amount not less than the level required under clause 2.38.1 within one Business Day.

2.38.4. The Credit Support for a Market Participant or Network Operator must be:

- (a) an obligation in writing that:
 - i. is from a credit support provider, who must be an entity which meets the Acceptable Credit Criteria and which itself is not a Market Participant;
 - ii. is a guarantee or bank letter of credit in a form prescribed by the IMO;
 - iii. is duly executed by the credit support provider and delivered unconditionally to the IMO;
 - iv. constitutes valid and binding unsubordinated obligations to the credit support provider to pay to the IMO amounts in accordance with its terms which relate to obligations of the relevant Market Participant or Network Operator under the Market Rules; and
 - v. permits drawings or claims by the IMO to a stated amount; or
- (b) a cash deposit ("**Security Deposit**") made with the IMO by or on behalf of the Market Participant or Network Operator.

2.38.5. Where Credit Support is provided as a Security Deposit in accordance with clause 2.38.4(b), it will accrue interest daily at the Bank Bill Rate, and the IMO must pay the Market Participant or Network Operator the interest accumulated at the end of each calendar month less any liabilities and expenses incurred by the IMO, including bank fees and charges.

2.38.6. An entity meets the Acceptable Credit Criteria if it is:

- (a) either:
 - i. under the prudential supervision of the Australian Prudential Regulation Authority; or
 - ii. a central borrowing authority of an Australian State or Territory which has been established by an Act of Parliament of that State or Territory;
- (b) resident in, or has a permanent establishment in, Australia;
- (c) not an externally-administered body corporate (within the meaning of the Corporations Act), or under a similar form of administration under any laws applicable to it in any jurisdiction;

Chapter 2

- (d) not immune from suit;
- (e) capable of being sued in its own name in a court of Australia; and
- (f) has an acceptable credit rating, being either:
 - i. a rating of A-1 or higher for short term unsecured counterparty obligations of the entity, as rated by Standard and Poor's (Australia) Pty. Limited; or
 - ii. a rating of P-1 or higher for short term unsecured counterparty obligations of the entity, as rated by Moodys Investor Services Pty. Limited.

Note that the following sections relating to trading limits and margin calls do not apply to Network Operators with Network Control Services Contracts – there is no uncertainty about the upper limit of the level of payments they will be required to make, so they only need to provide their Credit Support.

2.39. Trading Limit

2.39.1. The Trading Limit for a Market Participant is to equal the prudential factor specified in clause 2.39.2 multiplied by the total amount which can be drawn or claimed under, or applied from, its Credit Support.

2.39.2. The prudential factor is 0.87.

This initial prudential factor has been determined as one minus the ratio of the maximum number of days required for a participant to be suspended following a margin call which leads to a “suspension event” (as described in clause 9.23) divided by the maximum number of days between the start of a Trading Month and the non-STEM settlement statement being issued for that month. A margin call requires a response in 1 business day, a market participant can be given up to 5 business days (7 days assumed) to respond to a suspension event, and 1 day might elapse in actually suspending the participant. Hence the numerator is about 9 days. The period from the first day of a Trading Month until that month is settled is about 69 days. Hence the prudential factor is $1 - (9 / 69) = 0.87$. This result has been tested under more detailed models and is quite robust.

2.40. Outstanding Amount

2.40.1. The Outstanding Amount for a Market Participant at any time equals the greater of:

- (a) zero; and
- (b) the total amount calculated as follows:
 - i. the aggregate of the amounts payable by the Market Participant to the IMO under these Market Rules, including amounts for all past periods for which no Settlement Statement has yet been issued, and whether or not the payment date has yet been reached; less

- ii. the aggregate of the amounts payable by the IMO to the Market Participant under these Market Rules, including amounts for all past periods for which no Settlement Statement has yet been issued, and whether or not the payment date has yet been reached.

2.40.2. The amounts to be used for the purposes of making the calculation under clause 2.40.2(b)(i) and (ii) will be the actual amounts for which Settlement Statements have been issued by the IMO and the IMO's reasonable estimate of other amounts.

2.41. Trading Margin

2.41.1. The Trading Margin for a Market Participant at any time equals the amount by which its Trading Limit exceeds its Outstanding Amount at that time.

2.41.2. A Market Participant must not make any Submission to the IMO where the transaction contemplated by the Submission could result in the Trading Margin of the Market Participant being exceeded, were the transaction to be valued according to the expected value guidelines referred to in clause 2.37.9.

2.41.3. The IMO may reject any Submission from a Market Participant where in the IMO's opinion the transaction contemplated by the Submission could result in the Trading Margin of the Market Participant being exceeded, were the transaction to be valued according to the expected value guidelines referred to in clause 2.37.9.

The main settlement payments by a participant will arise from STEM purchases, and from balancing and reserve capacity payments.

2.41.4. The IMO may notify a Market Participant at any time of the level of their Trading Margin.

2.42. Margin Call

2.42.1. If, at any time, a Market Participant's Trading Margin drops to zero or below, then the IMO may issue a Margin Call Notice to the Market Participant, specifying the amount of the Margin Call.

2.42.2. The Typical Accrual for a Market Participant at any time is the amount that the IMO determines would have been the Outstanding Amount of the Market Participant at that time if the prices and quantities applying to amounts payable by the Market Participant were equal to the average prices and quantities as applied in the most recent determination of the Market Participant's Credit Limit.

2.42.3. The amount of the Margin Call must be equal to the Market Participant's Outstanding Amount less the Market Participant's Typical Accrual.

Chapter 2

2.42.4. Where a Margin Call Notice is issued, the Market Participant must within one Business Day from the Margin Call Notice being issued respond to the Margin Call by either:

- (a) paying to the IMO in cleared funds a Security Deposit as contemplated under clause 2.38.4(b); or
- (b) ensuring the IMO has the benefit of additional Credit Support of the kind contemplated by clause 2.38.4(a),

in the amount of the Margin Call.

2.42.5. The IMO may cancel a Margin Call Notice at any time. The cancellation of a Margin Call Notice does not affect the IMO's rights to issue a further Margin Call Notice on the same grounds that gave rise to the original Margin Call Notice.

2.42.6. Where a Market Participant fails to comply with clause 2.42.4 the provisions of clause 9.23 apply.

2.42.7. Where the IMO issues a Margin Call Notice, it must review the Credit Limit of the relevant Market Participant and increase the Credit Limit in line with the amount of the Margin Call.

2.43. Prudential Market Procedure

2.43.1. The IMO must develop a Market Procedure dealing with:

- (a) determining Credit Limits;
- (b) assessing persons against the Acceptable Credit Criteria;
- (c) Credit Support arrangements, including:
 - i. the form of acceptable guarantees and bank letters of credit;
 - ii. where and how it will hold cash deposits and how the costs and fees of holding cash deposits will be met;
 - iii. the application of monies drawn from Credit Support in respect of amounts owed by the relevant Market Participant to IMO;
- (d) calculation of Trading Margins;
- (e) guidelines for assessing the expected value of transactions;
- (f) issuing of Margin Calls; and
- (g) other matters relating to clauses 2.37 to 2.42,

and Market Participants and the IMO must comply with that Market Procedure.

Emergency Powers

2.44. Minister's Emergency Powers

- 2.44.1. If the Minister requests the IMO to suspend the application of all or any of these Market Rules (other than this clause 2.44) or any element of the market in connection with the exercise of emergency powers under the Energy Operators (Powers) Act 1979 or under emergency provisions of other legislation, then the IMO must do so.
- 2.44.2. The IMO must lift a suspension as soon as practicable after the Minister requests the IMO to do so.
- 2.44.3. The IMO must promptly notify Market Participants of any suspension or lifting of a suspension.
- 2.44.4. During a suspension, the IMO may give directions to Market Participants as to the operation of the market, and Market Participants must comply with those directions.

May need to consider giving the IMO the power to suspend the market if its or System Management's IT systems (and any backup systems) are not working (or other similar circumstances) such that the IMO or System Management cannot perform their functions.

3 Power System Security and Reliability

Security and Reliability

3.1. SWIS Operating Standards

- 3.1.1. The frequency and time error standards for a Network in the SWIS are as defined in the Technical Rules that apply to that Network.
- 3.1.2. The voltage standards for a Network in the SWIS are as defined in the Technical Rules that apply to that Network.

3.2. Technical Envelope, Security and Equipment Limits

- 3.2.1. An equipment limit means any limit on the operation of a Facility's equipment that is provided as Standing Data for the Facility to System Management by the IMO in accordance with clause 2.34.1(b).
- 3.2.2. System Management must record Equipment Limit information in accordance with the Power System Operation Procedure.
- 3.2.3. A Security Limit means any technical limit on the operation of the SWIS as a whole, or on a region of the SWIS, necessary to maintain Power System Security, including both static and dynamic limits, and including limits to allow for and to manage contingencies.
- 3.2.4. Network Operators, in consultation with System Management, must determine any Security Limit in accordance with the Power System Operation Procedure, and System Management must record Security Limit information in accordance with the Power System Operation Procedure.
- 3.2.5. The Technical Envelope represents the limits within which the SWIS can be operated in each SWIS Operating State. In establishing and modifying the Technical Envelope under clause 3.2.6, System Management must:
 - (a) respect all Equipment Limits;
 - (b) respect all Security Limits;
 - (c) respect all SWIS Operating Standards;
 - (d) respect all Ancillary Service standards specified in clause 3.10; and
 - (e) take into account those parts of the SWIS which are not designed to be operated to the planning criteria in the relevant Technical Code.
- 3.2.6. System Management must establish and modify the Technical Envelope in accordance with clause 3.2.5 and the Power System Operation Procedure.

Chapter 3

3.2.7. System Management must develop a Power System Operation Procedure documenting:

- (a) the process to be followed by System Management in maintaining Equipment Limit information;
- (b) the process to be followed by Network Operators and System Management in determining the Security Limits and maintaining Security Limit information;
- (c) the process to be followed by System Management in establishing and modifying the Technical Envelope; and
- (d) the processes to be followed by System Management to enable it to operate the SWIS according to the Technical Envelope applicable to each SWIS Operating State.

3.2.8. System Management must operate the SWIS in accordance with the Power System Operation Procedure and the Technical Envelope for the applicable SWIS Operating State.

3.3. Normal Operating State

3.3.1. The SWIS is in a Normal Operating State when System Management considers that all of the following circumstances apply:

- (a) the voltage magnitudes at all energised busbars at every switchhouse, switchyard or substation of the SWIS are within the applicable Security Limits;
- (b) the MVA flows on all Registered Facilities are within the applicable Security Limits;
- (c) all other electric plant forming part of, or having or likely to have a material impact on the operation of, the SWIS is being operated within any applicable Equipment Limits and Security Limits;

These limits would include allowance for credible contingencies.

- (d) the configuration of the SWIS is such that the severity of any potential fault is within the capability of circuit breakers to disconnect the faulted circuit or equipment;
- (e) the frequency at all energised busbars at every switchhouse, switchyard or substation of the SWIS is within the normal operating frequency band of the SWIS Operating Standards;
- (f) the levels of all Ancillary Services being provided meet the Ancillary Service Requirements; and
- (g) conditions on the SWIS are secure in accordance with the requirements of the Technical Envelope.

Note that this is almost the same as the “secure operating state” used in the NEM.

Chapter 3

3.3.2. When the SWIS is in a Normal Operating State, System Management must:

- (a) not require a Registered Facility to be operated inconsistently with the Security Standards or its Equipment Limits for the Normal Operating State;
- (b) not utilise the overload capacity of Scheduled Generators (as indicated in Standing Data);
- (c) schedule and dispatch Ancillary Services in accordance with the Ancillary Service Requirements;
- (d) subject to clause 3.19, accept applications for the scheduling of outages unless System Management considers that these would endanger Power System Security or Power System Reliability; and
- (e) not take any actions that in its opinion would be reasonably likely to lead to a High-risk Operating State.

3.3.3. System Management may include in the Power System Operation Procedure guidelines describing matters it will take into account in making a determination under clause 3.3.1.

System Management will also be dispatching the system in accordance with the dispatch rules in Chapter 7.

3.4. High Risk Operating State

3.4.1. The SWIS is in a High-risk Operating State when System Management considers that any of the following circumstances exist, or are likely to exist within the next fifteen minutes, or are likely to exist at a time beyond the next fifteen minutes but actions other than those allowed under the Normal Operating State must be implemented immediately by System Management so as to moderate or avoid the circumstance:

- (a) there is a violation of the Spinning Reserve requirements determined in accordance with clause 3.11;
- (b) insufficient Load Following range is available to meet the requirements determined in accordance with clause 3.11;
- (c) there is a voltage deviation of greater than $\pm 6\%$ from the values determined in accordance with clause 3.1.2;
- (d) there is a frequency deviation of greater than ± 0.12 Hz from the values determined in accordance with clause 3.1.1 at an energised busbar at any switchyard or substation of the SWIS;
- (e) a transmission line is overloaded but the overload can be managed for the timeframe during which the overload is expected to be rectified;
- (f) there is a short circuit condition that could result in equipment fault levels being exceeded;

Chapter 3

- (g) there would be an overload, under-voltage situation or threat to the stability of the power system if a credible contingency occurred;
- (h) System Management is aware that one or more Market Participants have been notified by fuel suppliers and/or fuel transporters that a fuel shortfall is likely in relation to one or more Registered Facilities, where such fuel shortfall will limit the availability of generation during the next 24 hours, and where this might affect Power System Security or Power System Reliability;
- (i) imminent generator unavailability that would cause supply to fall below load;
- (j) significant SCADA system degradation is occurring which limits System Management's ability to control the power system;
- (k) there is a major bushfire or storm near, or forecast to be near, elements of the SWIS; and
- (l) any other circumstance having a substantially similar effect to any of the above occurs in connection with the SWIS.

3.4.2. When the SWIS is in a High Risk Operating State, System Management must:

- (a) not require Registered Facilities to operate inconsistently with the Security Standards or their Equipment Limits for the High Risk Operating State; and
- (b) schedule and dispatch Ancillary Services appropriate for the High Risk Operating State in accordance with Ancillary Service Requirements.

3.4.3. When the SWIS is in a High Risk Operating State, System Management may:

- (a) cancel or defer Planned Outages that have not yet commenced;
- (b) require the return to service in accordance with the relevant Outage Contingency Plan of Network equipment undergoing Planned Outages, or take other measures contained in the relevant Outage Contingency Plan for any Registered Facility; and
- (c) utilise the overload capacity of Scheduled Generators (as indicated in Standing Data).

3.4.4. System Management may take any other actions as it considers are required, consistent with good electricity industry practice, to return the SWIS to a Normal Operating State provided it acts with as little disruption to electricity supply and to the implementation of Resource Plans that it has received from the IMO as is reasonably practicable in the circumstances.

3.4.5. System Management must return the SWIS from a High Risk Operating state to a Normal Operating State as soon as it is able.

There is no time limit imposed on the duration of a High Risk or Emergency Operating State – these do not define planning or service standards. Rather, System Management is

Chapter 3

required to return the system to a Normal Operating State as soon as possible. If the system cannot be returned to a Normal Operating State, then, depending on SWIS conditions, a High Risk or Emergency Operating State will remain in force until such time as normal operation can be resumed.

3.4.6. When the SWIS is in a High Risk Operating State, Rule Participants must:

- (a) subject to clause 3.4.7, comply with directions issued by System Management in accordance with clauses 3.4.3 and 3.4.4; and
- (b) otherwise, use reasonable endeavours to assist System Management to return the SWIS to a Normal Operating State.

3.4.7. A Rule Participant is not required to comply with directions issued by System Management, issued in accordance with clauses 3.4.3 or 3.4.4, if such compliance would endanger the safety of any person, damage equipment, or breach any applicable law.

3.4.8. Where a Rule Participant cannot comply with a direction issued by System Management it must inform System Management immediately.

3.4.9. System Management may include in the Power System Operation Procedure guidelines describing matters it will consider in making a determination under clause 3.4.1.

3.5. Emergency Operating State

3.5.1. The SWIS is in an Emergency Operating State when System Management considers that any of the following circumstances exist, or are likely to exist within the next fifteen minutes, or are likely to exist after fifteen minutes but actions other than those allowed under the Normal Operating State or High-risk Operating State must be implemented immediately by System Management so as to moderate or avoid the circumstance:

- (a) there is a frequency deviation of greater than ± 0.5 Hz from the values determined in accordance with clause 3.1.1 for more than five minutes at any energised busbar at any switch-yard or substation of the SWIS;
- (b) there is a voltage deviation of greater than $\pm 10\%$ from the values determined in accordance with clause 3.1.2 for more than five minutes;
- (c) circuit currents exceed hard circuit ratings;
- (d) System Management expects a significant generation shortfall;
- (e) significant involuntary load interruption is occurring;
- (eA) operation under a Normal Operating State or a High-Risk Operating State would pose a significant risk to the physical safety of the public or field personal;

Chapter 3

- (f) significant primary SCADA system failure is occurring which has forced System Management to move power system control away from its primary control centre; or
- (g) significant transmission separation is occurring, or is imminent, resulting in limited power transfer and power system instability; and
- (h) any other circumstance having a substantially similar effect to any of the above occurs in connection with the SWIS.

3.5.2. An Emergency Operating State as defined in these Market Rules does not necessarily correspond to a civil emergency, or emergencies as defined in legislation but may commence as a result of these.

3.5.3. System Management must not take any actions that in its opinion would be reasonably likely to lead to an Emergency Operating State.

In accordance with clause 7.11, System Management must inform all Market Participants and Network Operators as soon as practical when the SWIS enters or leaves an Emergency Operating State

3.5.4. When the SWIS is in an Emergency Operating State, System Management must not require Registered Facilities to operate inconsistently with the Security Standards or their Equipment Limits for the Emergency Operating State.

3.5.5. When the SWIS is in an Emergency Operating State, System Management may:

- (a) direct any Rule Participant to provide Ancillary Services, whether that Rule Participant has an Ancillary Services Contract in relation to the relevant Facility or not;
- (b) utilise the overload capacity of Scheduled Generators (as indicated by Standing Data);
- (c) cancel or defer Planned Outages, require the return to service in accordance with the relevant Outage Contingency Plan of Registered Facilities undergoing Planned Outages or take other measures contained in the relevant Outage Contingency Plans;
- (d) issue directions to Rule Participants to operate their Registered Facilities in specific ways; and
- (e) take such other actions as it considers are required, consistent with good electricity industry practice, to restore the SWIS to a Normal Operating State, or to restore the SWIS to a High Risk Operating State where a Normal Operating State is not immediately achievable.

3.5.6. System Management must return the SWIS from an Emergency Operating State to a Normal Operating State as soon as it is able.

Chapter 3

- 3.5.7. Subject to clause 3.5.6, while operating under an Emergency Operating State, System Management must attempt to operate the SWIS in such a way as to, first minimise the disruption to electricity supply, and then, minimise the disruption to the implementation of Resource Plans, to the extent that is reasonably practicable to do so in the circumstances.
- 3.5.8. When the SWIS is in an Emergency Operating State, Rule Participants must:
- (a) subject to clause 3.5.9, comply with directions issued by System Management in accordance with clause 3.5.5; and
 - (b) otherwise, use their best endeavours to assist System Management to return the SWIS to a Normal Operating State.

Note that best endeavours here will be read in the context of actions within the time available.

- 3.5.9. A Rule Participant is not required to comply with directions issued by System Management, issued in accordance with clause 3.5.5, if such compliance would endanger the safety of any person, damage equipment, or breach any applicable law.
- 3.5.10. Where a Rule Participant cannot comply with a direction issued by System Management in accordance with clause 3.5.5 it must inform System Management immediately.
- 3.5.11. System Management may include in the Power System Operation Procedure guidelines describing matters it will consider in making determination under clause 3.5.1.

3.6. Demand Control

- 3.6.1. System Management must determine the aggregate requirements for automatic under frequency load shedding in accordance with the SWIS Operating Standards.
- 3.6.2. System Management must produce operational plans to implement the aggregate under frequency load shedding requirements. These operational plans must account for sensitive loads and for the rotation of loads between load shedding bands.

Note that any consultation needed to determine which loads are “sensitive” is up to System Management, and no formal process is set out in the Rules.

- 3.6.3. System Management must ensure that the operational plans have the approval of the IMO.
- 3.6.4. System Management must inform all Network Operators of its operational plans for under frequency load shedding.

Chapter 3

3.6.5. Network Operators must implement System Management's operational plans for automatic under frequency load shedding approved by the IMO by:

- (a) setting their automatic under frequency load shedding equipment in accordance with System Management's operational plans, including the rotation of loads between load shedding bands;
- (b) maintaining the equipment which will implement the automatic under frequency load shedding in good order; and
- (c) reporting to System Management at the times required by System Management on their compliance with System Management's operational plans.

3.6.6. System Management must make plans for manual load shedding, and must inform Network Operators of these plans.

3.6.6A System Management may issue manual disconnection directions to Network Operators, where such directions must be in accordance with System Management's load shedding plans.

3.6.6B. Network Operators must comply with any manual disconnection directions received from System Management.

Additional load shedding arrangements may appear in the Technical Codes instead of the Market Rules to the extent that they are related to Network Operator functions

3.7. System Restart

3.7.1. System Management must make operational plans and preparations to restart the SWIS in the event of system shutdown.

3.7.2. System Management must use its reasonable endeavours to restart the SWIS in the event of system shutdown.

Some of the system restart arrangements may appear in the Access Code or Technical Codes to the extent that they are related to Network Operator functions.

3.8. Investigating Incidents in the SWIS

This section relates to operational events in the SWIS. It focuses on any changes needed to the market rules or procedures. Other bodies may conduct other investigations focussing on other issues – eg safety.

3.8.1. System Management must notify the IMO of any incidents in the operation of equipment comprising the SWIS that:

- (a) endangers Power System Security or Power System Reliability to a significant extent; or

Chapter 3

- (b) causes significant disruption to the operation of the dispatch process set out in clauses 7.6. and 7.7.

Investigations would only be required for unusual events that either affected the Security and Reliability of the power system in a significant way, or caused a major disturbance in the way the dispatch process is applied.

3.8.2.

- (a) The IMO must coordinate an investigation into an incidents that is notified to it by System Management in accordance with clause 3.8.1 which the IMO considers have had, or had the potential to have had, a significant impact on the effectiveness of the market.
- (b) The IMO may require System Management and the Rule Participants involved in the incident to provide a report on the incident within a reasonable time period specified by the IMO.
- (c) System Management or a Rule Participant must comply with any request by the IMO for a report under paragraph (b).
- (d) The IMO may conduct its own investigation of, or engage independent experts to report on, the incident.

3.8.3. Following the investigation, the IMO must publish a report detailing its findings and including:

- (a) any reports provided in accordance with clause 3.8.2(d) after the IMO has removed any information that cannot be made public under these Market Rules or which the IMO considers should not be released; and
- (b) a description of any changes to the Market Rules or Market Procedures that the IMO considers necessary to prevent the future occurrence of similar incidents.

3.8.4. Where the IMO considers that changes in the Market Rules are necessary, it must draft a suitable Rule Change Proposal and progress it using the rule change process in clauses 2.5 to 2.8.

3.8.5. Where the IMO considers that changes in a Market Procedure which these Market Rules contemplate will be developed by the IMO are necessary, it must draft a suitable Procedure Change Proposal and progress it using the Procedure change process in clause 2.10.

3.8.6. Where the IMO considers that changes in a Market Procedure which these Market Rules contemplate will be developed by System Management are necessary, it must advise System Management, and System Management must draft a suitable Procedure Change Proposal and progress it using the Procedure change process in clause 2.10.

Ancillary Services

3.9. Definitions of Ancillary Services

3.9.1. Load Following Service is the service of frequently adjusting the output of one or more Scheduled Generators within a Trading Interval so as to match total system generation to total system load in real time in order to correct any SWIS frequency variations.

Load following is the primary mechanism in real-time to ensure that supply and demand are balanced. In effect, Load Following accounts for the difference between the schedules and dispatch instructions and the actual load.

3.9.2. Spinning Reserve Service is the service of holding capacity associated with a synchronised Scheduled Generator, Dispatchable Load or Interruptible Load in reserve so that the relevant Facility is able to respond appropriately in any of the following situations:

- (a) to retard frequency drops following the failure of one or more Registered Facilities; and
- (b) in the case of Spinning Reserve Service provided by Scheduled Generators and Dispatchable Loads, to supply electricity if the alternative is to trigger involuntary load curtailment.
- (c) [Blank]

3.9.3. Spinning Reserve response is measured over three time periods following a contingency event. A provider of Spinning Reserve Service must be able to ensure the relevant Facility can:

- (a) respond appropriately within 6 seconds and sustain or exceed the required response for at least 60 seconds; or
- (b) respond appropriately within 60 seconds and sustain or exceed the required response for at least 6 minutes; or
- (c) respond appropriately within 6 minutes and sustain or exceed the required response for at least 15 minutes,

for any individual contingency event.

3.9.4. [Blank]

3.9.5. [Blank]

3.9.6. Load Rejection Reserve Service is the service of holding capacity associated with a Scheduled Generator or Dispatchable Load in reserve so that:

- (a) the Scheduled Generator can reduce output rapidly; or

Chapter 3

(b) the Dispatchable Load can increase consumption rapidly, in response to a sudden decrease in SWIS load.

3.9.7. Load Rejection Reserve response is measured over two time periods following a contingency event. A provider of Load Rejection Reserve Service must be able to ensure that the relevant Facility can:

- (a) respond appropriately within 6 seconds and sustain or exceed the required response for at least 6 minutes; or
- (b) respond appropriately within 60 seconds and sustain or exceed the required response for at least 60 minutes,

for any individual contingency event.

3.9.8. System Restart Service is the ability of a Registered Facility which is a generation system to start without requiring energy to be supplied from a Network to assist in the re-energisation of the SWIS in the event of system shut-down.

3.9.9. Dispatch Support Service is any other ancillary service that is needed to maintain Power System Security and Power System Reliability that are not covered by the other Ancillary Service categories. Dispatch Support Service is to include the service of controlling voltage levels in the SWIS, where that service is not already provided under any Arrangement for Access or Network Control Service Contract.

Most of the voltage control is likely be provided under the access regime, and any provision under the requirements of an access agreement will not require Ancillary Service payments. The service here is to allow for the possibility that System Management requires provision of a service in excess of that required by access.

3.10. Ancillary Service Standards

3.10.1. The standard for Load Following Service is a level which is sufficient to:

- (a) provide Minimum Frequency Keeping Capacity, where the Minimum Frequency Keeping Capacity is the greater of:
 - i. 30 MW; and
 - ii. the capacity sufficient to cover 99.9% of the short term fluctuations in load and output of Non-Scheduled Generators and uninstructed output fluctuations from Scheduled Generators, measured as the variance of 1 minute average readings around a thirty minute rolling average.

(b) [Blank]

3.10.2. The standard for Spinning Reserve Service is a level which satisfies the following principles:

- (a) the level must be sufficient to cover the greater of:

Chapter 3

- i. 70% of the total output, including parasitic load, of the generation unit synchronised to the SWIS with the highest total output at that time; and
- ii. the maximum load ramp expected over a period of 15 minutes;

Note that the inclusion of parasitic load may be considered further.

- (b) the level must include capacity utilised to meet the Load Following Service standard under clause 3.10.1, so that the capacity provided to meet the Load Following requirement is counted as providing part of the Spinning Reserve requirement;

The Load Following and Load Ramp requirements will be met only by generators. The remaining part of the Spinning Reserve requirement, if any, can be met by interruptible load as well.

- (c) the level may be relaxed by up to 12% by System Management where it expects that the shortfall will be for a period of less than 30 minutes; and
- (d) the level may be relaxed following activation of Spinning Reserve and may be relaxed by up to 100% if all reserves are exhausted and to maintain reserves would require involuntary load shedding. In such situations the levels must be fully restored as soon as practicable.

3.10.3. [Blank]

3.10.4. The standard for Load Rejection Reserve Service is a level which satisfies the following principles:

- (a) the level sufficient to keep over-frequency below 51 Hz for all credible load rejection events;
- (b) may be relaxed by up to 25% by System Management where it considers that the probability of transmission faults is low.

3.10.5. The level of Load Following Service, Spinning Reserve Service and Load Rejection Reserve Service may be reduced:

- (a) following relevant contingencies; or
- (b) where System Management cannot meet the standard without shedding load, providing that System Management considers that reducing the level is not inconsistent with maintaining Power System Security.

System Management must attempt to recover the level of these Ancillary Services within 30 minutes, provided it can achieve this without shedding load.

3.10.6. The standard for System Restart Service is a level which is sufficient to meet System Management's operational plans as developed in accordance with clause 3.7.1.

Chapter 3

From these high level standards System Management will develop the annual requirements for each Ancillary Service.

3.11. Determining & Procuring Ancillary Service Requirements

3.11.1. System Management must determine all Ancillary Service Requirements in accordance with the SWIS Operating Standards and the Ancillary Service Standards.

3.11.2. System Management must update Ancillary Service Requirements on an annual basis. The Ancillary Service Requirements must be set based on the facilities and configuration expected for the SWIS in the coming year.

3.11.3. If it considers that a considerable shortfall of any Ancillary Service relative to the applicable Ancillary Service Standard is occurring, or is likely to occur before the next update under clause 3.11.2, System Management may reassess the level of the Ancillary Service Requirements for that Ancillary Service at that time.

3.11.4. System Management must determine the Ancillary Service Requirements in accordance with clause 3.11.1 and 3.11.5 for the:

- (a) Load Following Service;
- (b) Spinning Reserve Service;
- (c) [Blank]
- (d) Load Rejection Reserve Service;
- (e) each Dispatch Support Service; and
- (f) System Restart Service

The System Restart requirements will only need to change when there is a significant change in the configuration of the SWIS, so in most years this determination will simply be to roll forward the previous year's requirement.

3.11.5. The Ancillary Service Requirements may:

- (a) be location specific;
- (b) vary for different SWIS load levels or other scenarios;
- (c) vary by the type of day and time of day; and
- (d) vary across the year.

Variations across the year could be seasonal variations, or because of significant changes in the SWIS, e.g. a new power station.

3.11.6. System Management must submit the Ancillary Service Requirements to the IMO for approval. The IMO must audit System Management's determination of the Ancillary Service Requirements and may require System Management to redetermine the

Chapter 3

Ancillary Service Requirements, in which case this clause 3.11.6 applies to any recalculated requirements.

3.11.7. System Management must make an annual Ancillary Services plan describing how it will ensure that the Ancillary Service Requirements are met. The Ancillary Services plan must only include:

- (a) the Electricity Generation Corporation's Registered Facilities; and
- (b) facilities under the control of Rule Participants, where System Management has an Ancillary Services Contract with each of those Rule Participants.

We could limit the Ancillary Services Contracts to Market Participants, but this additional condition might exclude some parties who are Rule Participants and who would otherwise be happy to provide Ancillary Services to System Management without specifically registering any facilities.

3.11.7A. The Electricity Generation Corporation must make its capacity to provide Ancillary Services from its facilities available to System Management to a standard sufficient to enable System Management to meet its obligations in accordance with these Market Rules.

3.11.8. System Management may enter into an Ancillary Service Contract with a Rule Participant other than the Electricity Generation Corporation where:

- (a) it does not consider that it can meet the Ancillary Service Requirements with the Electricity Generation Corporation's Registered Facilities; or
- (b) the Ancillary Service Contract provides a less expensive alternative to Ancillary Services provided by the Electricity Generation Corporation's Registered Facilities.

There may be additional requirements to maintain some level of contracted ancillary services – for example interruptible load contracts.

Note that the provider of Ancillary Services under an Ancillary Services Contract does not need to be a Market Participant

3.11.9. Where it intends to enter into an Ancillary Service Contract, System Management must:

- (a) seek to minimise the cost of meeting its obligations under clause 3.12.1; and
- (b) give consideration to using a competitive tender process, unless System Management considers that this would not meet the requirements of paragraph (a).

3.11.10. Where System Management has entered into an Ancillary Service Contract, System Management must report the capacity of each Ancillary Service contracted,

Chapter 3

and the prices and terms for calling on the relevant Facility to provide that capacity to the IMO.

The ERA will also assess the Ancillary Service Contracts entered into and the process for entering into the contracts as part of its monitoring of System Management.

- 3.11.11. By 1 June each year, System Management must submit to the IMO a report containing information on:
- (a) the quantities of each of the Ancillary Services provided in the preceding year, including Ancillary Services provided under Ancillary Service Contracts, and the adequacy of these quantities;
 - (b) the total cost of each of the categories of Ancillary Services provided, including Ancillary Services provided under Ancillary Service Contracts, in the preceding year;
 - (c) the Ancillary Service Requirements for the coming year and the Ancillary Services plan to meet those requirements; and
 - (d) the budget approved in accordance with clause 2.23 for providing Ancillary Services for the coming year.
- 3.11.12. The IMO must audit System Management's determination of the Ancillary Services plan submitted to the IMO under clause 3.11.11. The IMO may require System Management to amend the Ancillary Services plan and resubmit it to the IMO, in which case this clause 3.11.12 applies to any amended plan.
- 3.11.13 By 1 July each year, System Management must have obtained the IMO's approval of a report provided under clause 3.11.11 or 3.11.12. The IMO must publish the approved report as soon as practicable.
- 3.11.14. System Management must document in the Power System Operation Procedure the procedure to be followed, and must follow that documented Market Procedure, when:
- (a) determining Ancillary Service Requirements;
 - (b) entering into Ancillary Service Contracts, including the process for conducting competitive tender processes utilised for the awarding of Ancillary Service Contracts; and
 - (c) preparing budget proposals for providing Ancillary Services.

3.12. Ancillary Service Dispatch

- 3.12.1. System Management must schedule and dispatch facilities to meet the Ancillary Service Requirements in each Trading Interval in accordance with Chapter 7.

Chapter 7 is the dispatch chapter.

Chapter 3

Clause 7.6 sets out the dispatch criteria, including a requirement to maintain Ancillary Services, and puts an obligation on System Management to dispatch the Electricity Generation Corporation's plant to meet the criteria. Clause 7.6.6 allows Dispatch Instructions in connection with Ancillary Services contracts that System Management has with other Market Participants.

3.13. Payment for Ancillary Services

3.13.1. The total payments by the IMO on behalf of System Management for Ancillary Services in accordance with Chapter 9 comprise:

- (a) [Blank]
- (aA) for Load Following Service for each Trading Month:
 - i. a capacity payment $Capacity_LF$ calculated as;
 - 1. the Monthly Reserve Capacity Price in that Trading Month;
 - 2. multiplied by LFR, the capacity necessary to meet the Ancillary Service Requirement for Load Following in that month;
 - ii. an availability payment $Availability_Cost_LF(m)$ calculated in accordance with clause 9.9.2(d) for that Trading Month;

Clause 9.9.2(d) determines the share of the total Availability Cost for Ancillary Services associated with Load Following.

- (b) an amount $Availability_Cost_R(m)$ for Spinning Reserve for each Trading Month, which is calculated in accordance with clause 9.9.2(c) for that Trading Month; and
- (c) $Cost_LRD$, the monthly amount for Load Rejection Reserve, System Restart, and Dispatch Support services, determined in accordance with System Management's budget process described in clause 2.23.

3.13.1A. To allow the IMO to distribute the total payments described in clause 3.13.1 in accordance with Chapter 9, System Management must provide the IMO with settlement information for Ancillary Service Contracts in accordance with clauses 3.22.2 and 3.22.3.

3.13.2. Payments for usage of Ancillary Services are achieved through the operation of the Balancing mechanism settlement process, and no additional payments will be due by the IMO to System Management for the use of Ancillary Services.

3.13.3. The parameters $Margin_Peak$ and $Margin_Off-Peak$ to be used in the settlement calculation described in clause 9.9.2 are:

- (a) where the Economic Regulation Authority has not completed its first assessment of the efficient costs of System Management in accordance with clause 2.23.3:

- i. 15 % for Margin_Peak; and
 - ii. 12% for Margin_Off-Peak; and
- (b) determined by the Economic Regulation Authority, where the Economic Regulation Authority has completed its first assessment of the efficient costs of System Management in accordance with clause 2.23.3.

3.14. Ancillary Service Cost Recovery

3.14.1. Market Participant p's share of the Load Following Service payment cost in each Trading Month m is $Load_Following_Share(p,m)$ which equals :

- (a) the Market Participant's contributing quantity; divided by
- (b) the total contributing quantity of all Market Participants,

where a Market Participant's contributing quantity for Trading Month m is the sum of:

- i. the absolute value of the sum of the Metered Schedules for the Non-Dispatchable Loads, Interruptible Loads, Curtailable Loads registered by the Market Participant for all Trading Intervals during Trading Month m; and
- ii. the sum of the Metered Schedules for Non-Scheduled Generators registered by the Market Participant for all Trading Intervals during Trading Month m.
- iii. [Blank]

3.14.2. Market Participant p's share of the Spinning Reserve service payment costs in each Trading Interval t is $Reserve_Share(p,t)$ which equals the amount determined in Appendix 2.

3.14.3. Market Participant p's share of the Load Rejection Reserve, System Restart, Dispatch Support services payment costs in each Trading Month m is $Consumption_Share(p,m)$ determined in accordance with clause 9.3.7.

3.14.4. These values are used in the settlement calculations in Chapter 9.

This is an allocation of these costs based on per MWh consumption in the month.

The formulae for calculating reserve payment shares have changed and the FOFactor and Mo(f) parameters are no longer needed.

3.15. Review of Ancillary Service Requirements Process and Standards

3.15.1. From time to time, and at least once in every five year period starting from Energy Market Commencement, the IMO, with the assistance of System Management, must carry out a study on the Ancillary Service Standards and the basis for setting Ancillary Service Requirements. The study must include:

Chapter 3

- (a) technical analyses determining the relationship between the level of Ancillary Services provided and the SWIS Operating Standards set out in clause 3.1;
- (b) identification of the expected costs that would result from an increase in the requirements for Ancillary Services due to additional Facilities connecting to the SWIS;

For example if a generator larger than the largest existing generator were to be built.

- (c) a cost-benefit study on the effects on stakeholders of providing and using a variety of levels of each Ancillary Service; and
- (d) a public consultation process.

3.15.2. The IMO must publish a report containing:

- (a) the inputs and results of the technical and cost-benefit studies;
- (b) the submissions received by the IMO in the consultation process, a summary of those submissions, and any responses to issues raised in those submissions; and
- (c) any recommended changes to Ancillary Service Standards and the basis for setting Ancillary Service Requirements.

3.15.3. If the IMO recommends any changes in the report in clause 3.15.2, the IMO must make a Rule Charge Proposal in accordance with clause 2.5.1 to implement those changes.

Medium and Short Term Planning

3.16. Medium Term PASA

3.16.1. System Management must carry out a Medium Term PASA study by the 15th day of each month.

3.16.2. The Medium Term PASA study must consider each week of a three year planning horizon, starting from the month following the month in which the Medium Term PASA study is performed.

3.16.3. System Management must use the assembled data to assist it with respect to:

- (a) setting Ancillary Service Requirements over the year; and
- (b) outage planning for Registered Facilities; and
- (c) assessing the availability of Facilities providing Capacity Credits, and the availability of other capacity.

Chapter 3

3.16.4. Rule Participants must provide the following data to System Management in respect of each week in the Medium Term Planning horizon described in clause 3.16.2 by the time specified in the Power System Operation Procedure:

Where we refer to “future changes” in the following, current values are not required, as Standing Data will reflect this

- (a) for Network Operators:
 - i. future changes to transmission capacities and ratings of equipment, to the extent that these have been planned at the time of providing the data;
 - ii. in accordance with clause 3.18, confirmation of previous outage plans and any new outage plans; and
 - iii. future access quantities at entry and exit point to its Network;
- (b) for Market Generators:
 - i. planned future changes to generating facility capabilities and Ancillary Service capabilities;
 - ii. in accordance with clause 3.18, confirmation of previous outage plans and any new outage plans;
 - iii. any proposed closure of a Registered Facility;
 - iv. any energy constraints for any week in the Medium Term Planning horizon described in clause 3.16.2; and
 - v. estimated weekly output for Non-Scheduled Generators; and
- (c) for Market Customers:
 - i. [Blank]
 - ii. in accordance with clause 3.18, confirmation of previous outage plans and any new outage plans; and
 - iii. availability of Demand Side Management capacity.

3.16.5. In conducting a Medium Term PASA study, System Management may use information developed by System Management in relation to:

- (a) SWIS Operating Standards;
- (b) Ancillary Service Requirements;
- (c) Ancillary Service Contracts.

3.16.6. In conducting a Medium Term PASA study, System Management may, in place of information provided in accordance with clause 3.16.4, use information developed by System Management.

Chapter 3

3.16.7. Rule Participants must provide the information System Management requests, and any other data they are aware of that might be relevant to a Medium Term PASA study, within the timeframe specified in the Power System Operation Procedure.

3.16.8. System Management must review the information provided by Rule Participants, and where necessary, seek additional information or clarifications.

3.16.8A. Rule Participants must provide any additional information or clarifications requested by System Management, within the time frame specified in the Power System Operating Procedure.

3.16.9. By the 15th day of each month, System Management must provide to the IMO and the IMO must publish the following information developed as a result of its Medium Term PASA study for each week in the Medium Term Planning horizon described in clause 3.16.2:

- (a) peak load forecasts for the following scenarios:
 - i. mean;
 - ii. mean plus one standard deviation; and
 - iii. mean plus two standard deviations.
- (b) forecast total available generation capacity by constrained region;
- (c) forecast total available Demand Side Management capacity by week and by constrained region;
- (d) the amount equal to:
 - i. the load forecast referred to in (a)(iii); minus
 - ii. the total forecast available generation capacity; minus
 - iii. the total available Demand Side Management capacity;

This indicates where outages might be possible.

- (e) any weeks where there is expected to be a shortfall of capacity, including a shortfall of Ancillary Services or an inability to satisfy the Ready Reserve Standard;
- (f) transmission outages of which System Management is aware, forecast transmission capacity between potentially constrained regions, under normal conditions and some contingency scenarios, and any constraints that are likely under these scenarios;
- (g) possible security problems that could affect market or dispatch outcomes;
- (h) potential fuel supply, transport or storage limitations that could affect generation capacity of which System Management is aware;

Chapter 3

- (i) the details of any use by System Management of its own data in place of data provided in accordance with clause 3.16.6, and the reasons why System Management's data was substituted; and
- (j) for each approved Commissioning Test the Facility to be tested and the dates and times during which the Commissioning Test will be conducted.

3.16.10. System Management must document the procedure it follows in conducting Medium Term PASA studies in the Power System Operation Procedure and System Management must follow that documented Market Procedure when conducting a Medium Term PASA study.

3.17. Short term PASA

3.17.1. System Management must carry out a Short Term PASA study:

- (a) every Thursday, and provide the Short Term PASA results referred to in clause 3.17.9 to the IMO by 4:30 PM; and
- (b) on any other day if it determines that changes have occurred that would materially affect market outcomes during the first week of the period covered by the previous Short Term PASA study, and provide the Short Term PASA results referred to in clause 3.17.9 to the IMO as soon as practical.

3.17.2. The IMO must publish the Short Term PASA results referred to in clause 3.17.9 provided by System Management as soon as practicable after it receives it from System Management.

3.17.3. The Short Term PASA study must consider each six-hour period of a three week planning horizon ("**Short Term PASA Planning Horizon**"), starting from 8 AM on the day following the day on which the Short Term PASA study is performed.

3.17.4. System Management must use the Short Term PASA study to assist it in:

- (a) setting Ancillary Service Requirements in each six-hour period during the Short Term PASA Planning Horizon;
- (b) assessing final approval of Planned Outages; and
- (c) assessing the availability of capacity holding Capacity Credits in each six-hour period during the Short Term PASA Planning Horizon.

3.17.5. Rule Participants must submit information to System Management before 10 AM every Thursday, consisting of:

- (a) for a Network Operator, availability over the next Short-Term PASA Horizon of all Registered Facilities;
- (b) for a Market Generator, availability over the next Short-Term PASA Horizon of all its Registered Facilities which are generating works; and

Chapter 3

- (c) for a Market Customer, availability over the next Short-Term PASA Horizon of all its Registered Facilities which are Loads and demand forecasts for any other load facilities designated as significant by System Management.

3.17.6. Where a Rule Participant becomes aware that the information it submitted in accordance with clause 3.17.5 has materially changed during the first week of the period covered by the previous Short Term PASA study, then it must re-submit the relevant data to System Management as soon as possible, and in any case within 24 hours.

3.17.7. In conducting the Short Term PASA study, System Management may, use information developed by System Management in relation to:

- (a) SWIS Operating Standards;
- (b) Ancillary Service Requirements;
- (c) Ancillary Service Contracts;
- (d) load forecasts.

3.17.8. In conducting a Short Term PASA study, System Management may, in place of information provided in accordance with clause 3.17.5, use information developed by System Management.

3.17.9. System Management must ensure that the results of a Short Term PASA study which it provides to the IMO include for the Short Term PASA Planning Horizon:

- (a) peak load forecasts for the following scenarios:
 - i. mean;
 - ii. mean plus one standard deviation; and
 - iii. mean plus two standard deviations;
- (b) forecast total available generation capacity by six-hour period;
- (c) forecast total available Demand Side Management capacity by six-hour period;
- (d) by six-hour period, the amount equal to:
 - i. the load forecast referred to in (a)(iii); minus
 - ii. the total forecast available generation capacity; minus
 - iii. the total available Demand Side Management capacity;

This indicates where outages might be possible.

- (e) any six-hour periods where a shortfall of capacity is forecast, including a shortfall of Ancillary Services or an inability to satisfy the Ready Reserve Standard;

Chapter 3

- (f) transmission outages of which System Management is aware, forecast transmission capacity between potentially constrained regions, and any constraints that are likely;
- (g) possible security problems that could affect market or dispatch outcomes;
- (h) potential fuel supply, transport or storage limitations that could affect generation capacity of which System Management is aware;
- (i) the details of any use by System Management of its own data in place of data provided in accordance with clause 3.17.8, and the reasons why System Management's data was substituted; and
- (j) for each approved Commissioning Test the Facility to be tested and the dates and times during which the Commissioning Test will be conducted.

3.17.10. System Management must document the procedure it follows in conducting Short Term PASA studies in the Power System Operation Procedure and System Management must follow that documented Market Procedure when conducting a Short Term PASA study.

3.18. Outage Scheduling

Participants follow the outage scheduling process over two timeframes.

Clause 3.18 deals with the longer timeframe, when participants submit outage plans to System Management to be scheduled, according to the long term Security and Reliability criteria. System Management will enter outages into its schedule, and will periodically review these as part of the MT-PASA and ST-PASA processes.

Clause 3.19 then deals with the short term process - a few days before the scheduled outage the participant confirms that System Management accepts the outage plan, given the updated forecasts of the power system state that System Management has at that time. Participants can also apply to System Management for opportunistic maintenance.

3.18.1. Where a reference is made to an outage of a Facility or item of equipment in clauses 3.18, 3.19, 3.20 and 3.21, this includes partial and complete outages and de-ratings of the Facility or item.

3.18.2.

- (a) System Management must compile a list of all equipment on the SWIS that is required to be subject to outage scheduling by System Management. The list must also include equipment for which System Management requires notice of partial outages or de-ratings.
- (b) System Management must review the list described in paragraph (a) from time to time and may update the list.
- (c) The list described in paragraph (a) must include:

Chapter 3

- i. all transmission network Registered Facilities;
 - ii. all Registered Facilities holding Capacity Credits, except those to which clause 3.18.2A applies;
 - iiA. all generation systems to which clause 2.30B.2(a) relates, except those to which clause 3.18.2A applies;
 - iii. all Registered Facilities subject to an Ancillary Services Contract; and
 - iv. any other equipment that System Management determines must be subject to outage scheduling to maintain Power System Security and Power System Reliability.
- (d) The list described in paragraph (a) may specify that a piece of equipment on the list is subject to outage scheduling by System Management only at certain times of the year.
- (e) System Management must provide the list described in paragraph (a) and any updated list to the IMO. The IMO must publish any list provided by System Management.
- (f) If a Market Participant's or Network Operator's Facility (or an item of equipment forming part of that Facility) is on the list described in paragraph (a), then the Market Participant or Network Operator, as applicable, must schedule outages for the equipment in accordance with this clause 3.18 and clauses 3.19, 3.20 and 3.21.

3.18.2A.

- (a) Except where clause 3.18.2(c)(iv) applies, Registered Facilities with a Standing Data nameplate capacity of less than 10 MW and generation systems to which clause 2.30B.2(a) relates and which have a nameplate capacity of less than 10 MW are not required to schedule outages for that equipment in accordance with this clause 3.18 and clauses 3.19 and 3.20 other than as required by this clause 3.18.2A.

Note that these facilities are not exempted from clause 3.21 which relates to Forced Outages.

- (b) If (a) applies to a Market Participant's Facility or generation system then that Market Participant must notify System Management of proposed Planned Outages of that Facility or generation system not less than 2 Business Days prior to their commencement and must specify the duration of the Planned Outage;
- (c) Where System Management is advised of a proposed Planned Outage in accordance with (b) then System Management must record that outage as an approved Planned Outage.

Chapter 3

For the purpose of Reserve Capacity Mechanism operation it is necessary that there be a demarcation between Forced and Planned Outages for all Facilities holding Capacity Credits or serving Intermittent Load

3.18.3.

- (a) If a Market Participant's or Network Operator's Facility (or an item of equipment forming part of a Facility or an item of equipment which is a generation system to which clause 2.30B.2(a) relates) is on the list described in clause 3.18.2(a), then the Market Participant or Network Operator may request that the IMO reassess the inclusion of the Facility or item of equipment on the list in accordance with this clause 3.18.3.
- (b) Following a request by a Market Participant or Network Operator under paragraph (a), the IMO must consult with System Management and the Market Participant or Network Operator concerning whether the Facility or item of equipment should remain on the list.
- (c) The IMO may give a direction to System Management that a Facility or item of equipment should not remain on the list where it finds that:
 - i. System Management has not followed the Market Rules or the Power System Operation Procedure in compiling the list under clause 3.18.2; and
 - ii. if the Market Rules and the Power System Operation Procedure had been followed, then the Facility or item of equipment would not have been on the list.
- (d) Where the IMO gives a direction to System Management that the Facility or item of equipment does not need to remain on the list, System Management must remove the Facility or item from the list.

So the IMO can only overturn System Management's decision on procedural, not in relation to technical issues.

3.18.4. System Management must maintain an outage schedule, containing information on all scheduled outages.

3.18.4A. A proposal submitted to System Management in accordance with this clause 3.18 by a Market Participant or Network Operator in which permission is sought from System Management for the scheduling of the removal from service (or derating) of an item of equipment is a proposed outage plan ("**Outage Plan**").

3.18.5. Market Participants:

- (a) must, subject to clause 3.18.5A, submit to System Management details of a proposed Outage Plan at least one year but not more than three years in advance of the proposed outage, where:

Chapter 3

- i. the outage relates to a Facility or item of equipment in respect of which a Market Participant holds Capacity Credits at any time during the proposed outage;
 - ii. the Facility or item of equipment has a nameplate capacity greater than 10 MW; and
 - iii. the proposed outage has a duration of more than one week; and
- (b) otherwise may submit an Outage Plan to System Management not more than three years and not less than two days in advance of the proposed outage.

3.18.5A. Market Participants may submit an Outage Plan to which clause 3.18.5(a) relates to System Management less than one year, but not less than two days, in advance of the proposed outage, but in such instances:

- (a) System Management must give priority to Outage Plans to which clause 3.18.5(a) relate and which were received more than one year in advance of the commencement of the proposed outage;
- (b) System Management must give priority to Outage Plans to which this clause 3.18.5A relates in the order they are received; and
- (c) System Management must give no special priority to Outage Plans to which this clause 3.18.5A relates relative to Outage Plans to which clause 3.18.5(a) does not relate.

The intent of this is that if an outage with duration of more than a week is scheduled more than a year before the event then it will get priority over a similar outage scheduled less than a year before the event. An outage with a duration of more than a week scheduled less than a year before the event should be treated with the same priority as any other outage scheduled less than a year before the event, except that outages lasting more than a week will, to the extent possible, be approved in the order they are received.

Note that if outage A has priority over outage B the rules do not preclude the possibility that outage B will be accepted while outage A is rejected. The intent of the rules is that to the extent that both outages could be approved without having undue impact on other outages or long term system security, but outages A and B are mutually exclusive, then outage A will be accepted ahead of outage B.

3.18.5B. Network Operators may submit an Outage Plan to System Management not more than three years and not less than two days in advance of the proposed outage.

3.18.5C. Where a Network outage is likely to unduly impact the operation of one or more Market Participant Registered Facilities, System Management may require that in developing their Outage Plans the relevant Network Operator and affected Market Participants coordinate the timing of their outages so as to minimise the impact of the Network outage on the operation of the Market Participant Facilities.

Chapter 3

3.18.6. The information submitted in an Outage Plan must include:

- (a) identity of the Facility or item of equipment that will be unavailable;
- (b) the quantity of any de-rating;
- (c) the reason for the outage;
- (d) the proposed start and end times of the outage;
- (e) an assessment of risks that might extend the outage;
- (f) details of the time it would take the Facility or item of equipment to return to service, if required; and
- (g) contingency plans for the early return to service of the Facility or item of equipment (“**Outage Contingency Plans**”).

The return to service information will apply primarily to transmission facilities - e.g. alternative breaker settings to allow a transmission line to return to service quickly, but with lower than normal reliability

3.18.7. Outage Plans submitted by a Market Participant or Network Operator must represent the good faith intention of the Market Participant or Network Operator to remove from service, or de-rate, the relevant Facility or item of equipment, for maintenance.

3.18.7A. System Management may reject an Outage Plan first submitted within 6 weeks of the commencement time of the outage without evaluating that Outage Plan if, in the opinion of System Management, the submitting party has not allowed adequate time for the Outage Plan to be assessed.

3.18.8. Where a Market Participant or Network Operator no longer plans to remove from service, or de-rate, the relevant Facility or item of equipment, for maintenance it must inform System Management as soon as practicable.

3.18.9. Where a Market Participant or Network Operator intends to remove from service, or de-rate, the relevant Facility or item of equipment, for maintenance at a different time than indicated in an Outage Plan, it must submit a revised Outage Plan to System Management as soon as practicable.

3.18.10. System Management must use a risk assessment process using the criteria set out in clause 3.18.11 to evaluate Outage Plans:

- (a) when an Outage Plan is received or revised; and
- (b) on an ongoing basis as part of the Medium Term PASA and Short Term PASA studies.

3.18.11. System Management must apply the following criteria when evaluating Outage Plans:

Chapter 3

- (a) the capacity of the total generation and Demand Side Management Facilities remaining in service must be greater than the second deviation load forecast published in accordance with clause 3.16.9(a)(iii) or clause 3.17.9(a)(iii), as applicable;
- (aA) the capacity of the total generation and Demand Side Management Facilities remaining in service must satisfy the Ready Reserve Standard described in clause 3.18.11A;
- (b) the transmission capacity remaining in service must be capable of allowing the dispatch of the capacity referred to in paragraph (a);
- (c) the Facilities remaining in service must be capable of meeting the applicable Ancillary Service Requirements;
- (d) the Facilities remaining in service must allow System Management to operate the power system within the Technical Envelope; and
- (e) notwithstanding the criteria set out in paragraphs (a) to (d), System Management may allow an outage to proceed if it considers that preventing the outage would pose a greater threat to Power System Security or Power System Reliability over the long term than allowing the outage.

3.18.11A. The Ready Reserve Standard requires that the available generation and demand-side capacity at any time satisfies the following principles:

- (a) Subject to (c), the additional energy available within fifteen minutes must be sufficient to cover:
 - i. 30% of the total output, including parasitic load, of the generation unit synchronized to the SWIS with the highest total output at that time;
 - ii. plus the Minimum Frequency Keeping Capacity as defined in clause 3.10.1(a).
- (b) Subject to (c), and in addition to the additional energy described in (a), the additional energy available within four hours must be sufficient to cover ;
 - i. 70% of the total output, including parasitic load, of the generation unit synchronized to the SWIS with the second highest total output at that time;
 - ii. less the Minimum Frequency Keeping Capacity as defined in clause 3.10.1(a).
- (c) System Management may relax the requirements in (a) and (b) in the following circumstances:
 - i. where System Management expects that the load demand will be such that it exceeds the second standard deviation peak load forecast level, as described in clause 3.17.9(a), used in the most recently published Short Term PASA for that Trading Interval;

- ii. during the four hours following an event that has caused System Management to call on additional energy maintained in accordance with clauses (a) or (b).

The current Spinning Reserve Standard covers 70% of the largest unit (and not 100%). This is possible because Ready Reserve requires that a sufficient capacity is maintained on the system to cover the difference within 15 minutes. In effect, the Ready Reserve Standard enables Spinning Reserve standard to be set at its current level (as defined in clause 3.9.2).

3.18.12. Except to the extent required by the criteria in clause 3.18.11 and to the extent allowed by clause 3.18.5A, in evaluating Outage Plans, System Management must not show bias towards a Market Participant or Network Operator in regard to its Outage Plans.

3.18.13. Following an evaluation of a new Outage Plan or an Outage Plan or group of Outage Plans that System Management has previously accepted fully or subject to conditions:

- (a) System Management may find that an Outage Plan, or group of Outage Plans, when considered together, are acceptable, unacceptable or are acceptable under certain circumstances. If System Management finds that a group of Outage Plans when considered together are acceptable, unacceptable or acceptable under certain circumstances, then all the Outage Plans in that group have that status.
- (b) Where System Management finds that an Outage Plan is acceptable, then it must schedule the Outage Plan in System Management's outage schedule accordingly and inform the Market Participants or Network Operators that submitted the Outage Plans.
- (c) Where System Management finds that an Outage Plan is acceptable under certain circumstances, then it must inform the Market Participant or Network Operator that submitted the Outage Plan of its finding and the circumstances under which the Outage Plan would be acceptable. System Management must:
 - i. consult with the Market Participant or Network Operator about those circumstances;
 - ii. determine a date by which it expects to have sufficient information on those circumstances to reassess the Outage Plan;
 - iii. inform the Market Participant or Network Operator of the date; and
 - iv. reassess the outage plan using the criteria under clause 3.18.11 following the date specified in accordance with clause 3.18.13(c)(ii);
- (d) Where System Management finds that an Outage Plan is unacceptable, then System Management must inform all Market Participants and Network Operators affected and must negotiate with the affected Market Participants

and Network Operators to attempt to reach agreement as to System Management's outage schedule, and:

- i. If agreement is reached, then the affected Market Participants and Network Operators must resubmit Outage Plans to System Management; or
- ii. If no agreement is reached within 15 Business Days, System Management must:
 1. decide which of the Outage Plans are acceptable and schedule these Outages Plans into System Management's outage schedule where they are not already scheduled;
 2. decide which of the Outage Plans are unacceptable and remove these Outages Plans from the System Management's outage schedule where they were previously scheduled; and
 3. notify each affected Market Participant whether its Outage Plan has been scheduled.

(e) Where, as a result of an evaluation, the status of an Outage Plan that was previously acceptable or acceptable under certain conditions changes then System Management must modify its outage schedule accordingly.

3.18.14. System Management must use the following criteria when making a decision referred to in clause 3.18.13(d)(ii), in descending order of priority:

- (a) System Management must give priority to the criteria in clause 3.18.11;
- (b) System Management must give priority to Outage Plans that have previously been scheduled in System Management's outage schedule, in the order in which they were entered into the schedule. For the purposes of this clause an Outage Plan which has been entered into the outage schedule and has subsequently been revised in accordance with clause 3.18.9 is considered to have been entered into the schedule on the date the most recent revision of the Outage Plan was submitted under that clause;
- (c) System Management must have regard to the technical reasons for the requested maintenance, the technical implications for the relevant equipment if the maintenance is not carried out and a reasonable duration for maintenance carried out for those reasons; and

Note that extremely urgent maintenance may also be considered under the criterion in clause 3.18.11(e), if refusing the outage would cause a significant risk.

- (d) System Management must give priority to Outage Plans that would be more difficult to reschedule, including considering the amount of capacity that would be taken out of service and the duration of the outage.

Chapter 3

- 3.18.15. Where System Management informs a Market Participant or Network Operator that an Outage Plan has not been scheduled or has been removed from System Management's outage schedule under clause 3.18.13(d)(ii), the Market Participant or Network Operator may apply to the IMO to reassess the decision in accordance with the following procedures:
- (a) A Participant or Network Operator can only apply for the IMO to reassess a decision on the grounds that System Management has not followed the Market Rules or its Power System Operation Procedure;
 - (b) The Market Participant or Network Operator must submit a written application to the IMO, and forward a copy to System Management, stating the reasons why it considers that System Management's decision under clause 3.18.13(d)(ii) should be reassessed and providing any supporting evidence:
 - i. within ten Business Days of being informed of System Management's decision; and
 - ii. no later than five Business Days prior to the date when the outage would have commenced.
 - (c) Until the IMO completes its reassessment, System Management's decision continues to have effect and System Management and the Market Participant or Network Operator must continue to plan their operations on this basis.
 - (d) System Management must submit records relating to System Management's outage schedule around the date of the relevant outage to the IMO within two Business Days of being informed of the Market Participant's or Network Operator's application under paragraph (b).
 - (e) The IMO must consult with System Management and the Market Participant or Network Operator concerning the Outage Plan, and must make a complete reassessment by the earlier of:
 - i. ten Business Days of receiving the application under paragraph (b); or
 - ii. two Business Days prior to the date when the outage would have commenced.

Obviously the very short term reviews will not be as thorough as a review months in advance

- (f) The IMO may give a direction to System Management that the Outage Plan should be scheduled in System Management's outage schedule where it finds that:
 - i. System Management has not followed the Market Rules or its Power System Operation Procedure; and
 - ii. if the Market Rules and the Power System Operation Procedure had been followed, then the Outage Plan would have been scheduled; and

Chapter 3

- (g) Where the IMO gives a direction to System Management that the Outage Plan should be scheduled in System Management's outage schedule, System Management must schedule it into the outage schedule in accordance with the direction.
- 3.18.16. Where System Management informs a Market Participant or Network Operator that an Outage Plan is unacceptable, and the IMO does not give System Management a direction under clause 3.18.15(f), then System Management and the Market Participant or Network Operator must use their best endeavours to agree an alternative time for the relevant outage, and System Management must schedule the alternative time in its outage schedule.
- 3.18.17. System Management must keep records of all of its outage evaluations and decisions made in accordance with this clause 3.18, together with the reasons for each outage evaluation and decision, and must submit these records to the IMO:
- (a) in the event of a review referred to in clause 3.18.15; and
 - (b) not less than once every three months.
- 3.18.18. From time to time, and at least once in every five year period starting from Energy Market Commencement, the IMO, with the assistance of System Management, must conduct a review of the outage planning process against the Wholesale Market Objectives. The review must include a technical study of the effectiveness of the criteria in clause 3.18.11 and a broad consultation process with Rule Participants.
- 3.18.19. At the conclusion of a review under clause 3.18.18, the IMO must publish a report containing:
- (a) the inputs and results of the technical study;
 - (b) the submissions made by Rule Participants in the consultation process and any responses to issues raised in those submissions;
 - (c) any recommended changes to the outage planning process, formulated as one or more Market Rule changes or Market Procedure changes.
- 3.18.20. If the IMO recommends any changes in the report in clause 3.18.19, the IMO must either submit a Rule Change Proposal in accordance with clause 2.5.1 or initiate a Procedure Change Process in accordance with clause 2.10, as the case may be.
- 3.18.21. System Management must document the procedure it follows in conducting outage planning in the Power System Operation Procedure and System Management, the IMO, Market Participants and Network Operators must follow that documented Market Procedure when planning outages.

Chapter 3

Under the Procedure development and change clauses in chapter 2 the IMO must approve this Procedure.

3.19. Outage Approval

3.19.1. No later than two days prior to the date of commencement of any outage (“**Scheduled Outage**”) in System Management’s outage schedule, the Market Participant or Network Operator involved must request that System Management approve the Scheduled Outage proceeding, specifying the Trading Day and Trading Intervals during the Scheduled Outage will occur.

3.19.2. Market Participants and Network Operators may request that System Management approve an outage of a Facility or item of equipment that is not a Scheduled Outage (“**Opportunistic Maintenance**”) to be carried out during a Trading Day,

- (a) at any time between 6:00 AM and 10:00 AM on the Scheduling Day for that Trading Day, where the request relates to an outage to occur at any time and for any duration during the following Trading Day; or
- (b) at any time on the Trading Day not later than 1 hour prior to the commencement of the Trading Interval during which the requested outage is due to commence, where
 - i. the outage must be to allow minor maintenance to be performed;
 - ii. the outage must not require any changes in scheduled energy or ancillary services; and
 - iii. the outage must not exceed four hours duration and must end before the end of the Trading Day;

where the request must include all of the information specified in clause 3.18.6, and must specify the Trading Intervals during which the Opportunistic Maintenance will occur.

3.19.3. Subject to clause 3.19.3A, System Management must assess the request for approval of a Scheduled Outage or Opportunistic Maintenance, based on the information available to System Management at the time of the assessment, and applying the criteria set out in clause 3.19.6.

3.19.3A. In assessing whether to grant a request for Opportunistic Maintenance, System Management:

- (a) must not grant permission for Opportunistic Maintenance to begin prior to the first Trading Interval for which Opportunistic Maintenance is requested;

This ensures that Opportunistic Maintenance cannot be requested retrospectively.

- (b) must not approve Opportunistic Maintenance for a Facility or item of equipment on two consecutive Trading Days;

Chapter 3

This prevents participants using Opportunistic Maintenance to disguise Forced Outages.

- (c) may decline to approve Opportunistic Maintenance for a Facility or item of equipment where it considers that the request has been made principally to avoid exposure to Reserve Capacity refunds as described in clause 4.26 rather than to perform maintenance; and

Clause (c) gives System Management the power to refuse Opportunistic Maintenance where it is being used to avoid the participant being declared as being in Forced Outage (or otherwise not complying with Reserve Capacity obligations) and where no maintenance is actually expected to be performed.

- (d) may decline to approve Opportunistic Maintenance for a facility where it considers that inadequate time is available before the proposed commencement time of the outage to adequately assess the impact of that outage.

3.19.4. System Management must either approve or reject the Scheduled Outage or Opportunistic Maintenance and inform the Market Participant or Network Operator of its decision as soon as practicable.

3.19.5. Where a change in power system conditions after System Management has approved a Scheduled Outage or Opportunistic Maintenance means that the Scheduled Outage or Opportunistic Maintenance is no longer approvable applying the criteria in clause 3.19.6, System Management may decide to reject the Scheduled Outage or Opportunistic Maintenance. Where System Management makes such a decision, it must inform the relevant Market Participant or Network Operator of its decision immediately.

3.19.6. System Management must use the following criteria when considering approval of Scheduled Outages or Opportunistic Maintenance:

- (a) the capacity of the generation and Demand Side Management Facilities remaining in service must be greater than the load forecast for the relevant time period;
- (b) the Facilities remaining in service must be capable of meeting the Ancillary Service Requirements;
- (c) the Facilities remaining in service must allow System Management to operate the power system within the Technical Envelope;
- (d) where a group of outages when considered together, do not meet the criteria set out in paragraphs (a) to (c), then System Management should give priority:
 - i. to outages Scheduled in System Management's outage schedule more than one month ahead; then

Chapter 3

- ii. to previously Scheduled Outages that have been deferred in accordance with clauses 3.19.4 or 3.19.5, but were originally scheduled in System Management's outage schedule more than one month ahead; then
 - iii. to outages scheduled in System Management's outage schedule less than one month ahead; then
 - iv. to previously Scheduled Outages that have been deferred in accordance with clauses 3.19.4 or 3.19.5, but were originally scheduled in System Management's outage schedule less than one month ahead; then
 - v. to Opportunistic Maintenance; and
- (e) notwithstanding the criteria set out in paragraphs (a) to (d), System Management may allow a Scheduled Outage to proceed if it considers that rejecting it would pose a greater threat to Power System Security or Power System Reliability than accepting it.

3.19.7. Where System Management informs a Market Participant or Network Operator that an outage is rejected, then System Management and the Market Participant or Network Operator must use their best endeavours to find an alternative time for the relevant outage.

3.19.8. Subject to clause 3.19.9, Market Participants and Network Operators must comply with System Management's decision to reject an outage, and the relevant Market Participant or Network Operator must ensure that the outage is not taken.

3.19.9. Compliance with clause 3.19.8 is not required if such compliance would endanger the safety of any person, damage equipment, or violate any applicable law. Where a Rule Participant cannot comply with such a decision it must inform System Management as soon as practicable.

Participants who still take their plant out of service would also fail to meet their Reserve Capacity obligations, with the relevant payment implications.

3.19.10. Where a Market Participant or Network Operator has reason to believe that System Management has not followed the Market Rules or the Power System Operation Procedure in its decision to reject an outage it may report the decision to the IMO as a potential breach of the Market Rules in accordance with clause 2.13.4.

Because of the timescales involved, such actions will not take place before the time when the outage was to commence, and would involve an after the fact assessment.

3.19.11. An outage, including Opportunistic Maintenance, that is approved by System Management under clause 3.19.4 is a Planned Outage.

Chapter 3

3.19.12.

- (a) Where System Management informs a Market Participant or Network Operator that an Outage Plan previously scheduled in System Management's outage schedule is rejected within 48 hours of the time when the outage would have commenced in accordance with the Outage Plan, the Market Participant or Network Operator may apply to the IMO for compensation.
 - (aA) Compensation will only be paid where details of the relevant Outage Plan have been submitted to System Management at least one year in advance of the time when the outage would have commenced.
 - (b) Compensation will only be paid for the additional maintenance costs directly incurred by a Market Participant or Network Operator in the deferment or cancellation of the relevant outage.
- (c) Compensation will not be paid for Opportunistic Maintenance.
- (d) The Market Participant or Network Operator must submit a written request for compensation to the IMO within three months of System Management's decision, including invoices and other documents demonstrating the costs referred to in paragraph (b).
- (e) The IMO must determine the amount of compensation within one month of the submission of the application for compensation, and must notify the Market Participant or Network Operator of the amount determined and the reasons for its determination.
- (f) The determined amount of compensation:
 - i. if less than or equal to \$50,000, must be paid to the applicant in accordance with Chapter 9 in respect of the Trading Month during which the determination is made; and
 - ii. if greater than \$50,000, must be paid to the applicant in accordance with Chapter 9 in equal installments over between one and six Trading Months as determined by the IMO, where:
 - 1. if practicable, the IMO must endeavour not to recover more than \$50,000 in any Trading Month;
 - 2. interest is to be paid to the applicant calculated by the IMO in accordance with clause 9.1.3 if the amount is recovered over two or more Trading Months; and
 - 3. the Trading Month amounts are to be included in its Non-STEM Settlement Statement pertaining to each of the applicable Trading Months from the Trading Month during which the determination is made.

\$50,000 is proposed on the basis that it is of the order of 10% of the value of energy traded each Trading Month. If the compensation to be paid is greater than this amount, the IMO

Chapter 3

has the option to pay it all in one month, or to spread it across up to six months. The cost of the compensation is recovered via the Reconciliation settlement charges on Market Customers.

3.19.13. System Management must keep records of all of its outage evaluations and decisions made in accordance with this clause 3.19, together with the reasons for each outage evaluation and decision, and must submit these records to the IMO:

- (a) where requested by the IMO; and
- (b) not less than once every three months.

3.19.14. System Management must document the procedure it follows in conducting final approval of outages in the Power System Operation Procedure and System Management, Market Participants and Network Operators must follow that documented Market Procedure when conducting final approval of outages.

3.20. Outage Recall

3.20.1. Where the SWIS is in an Emergency Operating State, or High-Risk Operating State, System Management may direct a Market Participant or Network Operator that a Facility or item of equipment be returned to service from Planned Outages in accordance with the relevant Outage Contingency Plan, or take other measures contained in the relevant Outage Contingency Plan.

3.20.2. Subject to clause 3.20.3, Market Participants and Network Operators must comply with directions from System Management under clause 3.20.1.

3.20.3. Rule Participants are not required to comply with directions issued by System Management under clause 3.20.1 if such compliance would endanger the safety of any person, damage equipment, or violate any applicable law. Where a Rule Participant cannot comply with such a direction it must inform System Management as soon as practicable.

3.21. Forced Outages

3.21.1. A Forced Outage is any outage of a Facility or item of equipment on the list described in clause 3.18.2 that has not received System Management's approval, including:

- (a) outages or de-ratings for which no approval was received from System Management, excluding Consequential Outages;
- (b) any part of a Planned Outage that exceeds its approved duration; and
- (c) where the Market Participant or Network Operator does not follow a direction from System Management under clause 3.20.1 to return the equipment to service within the time specified in the appropriate contingency plan.

Chapter 3

3.21.2. A Consequential Outage is an outage of a Facility or item of equipment on the list described in clause 3.18.2 for which no approval was received by System Management, but which System Management determines:

- (a) was caused by a Forced Outage to another Rule Participant's equipment; and
- (b) would not have occurred if the other Rule Participant's equipment did not suffer a Forced Outage.

3.21.3. System Management must keep a record of all Forced Outages and Consequential Outages of which it is aware.

System Management must provide this list to the IMO for settlement purposes in accordance with clause 7.13. Note that System Management cannot record a Forced outage if no one told it about the outage and the capacity was not required to run.

3.21.4. If a Facility or item of equipment that is on the list described in clause 3.18.2 or a Facility or generation system to which clause 3.18.2A relates suffers a Forced Outage or Consequential Outage, then the relevant Market Participant or Network Operator must inform System Management of the outage as soon as practical. Information provided to System Management must include:

- (a) the time the outage commenced;
- (b) an estimate of the time the outage is expected to end;
- (c) the cause of the outage;
- (d) the Facility or item of equipment or Facilities or items of equipment affected; and
- (e) for each affected Facility or item of equipment, the expected available capacity by Trading Interval.

Commissioning Tests

3.21A Commissioning Tests

3.21A.1. A Commissioning Test ("Commissioning Test") is a test of the ability of a generating system to operate at different levels of output reliably.

3.21A.2. A Market Participant seeking to conduct a Commissioning Test for a Scheduled Generator or a candidate facility to be registered as a Scheduled Generator must request permission for such trials from System Management in accordance with clause 3.21A.4.

3.21A.3. System Management may only approve a Commissioning Test for new generating systems that are expected to be registered as Scheduled Generators, or for existing Scheduled Generators which have undergone significant maintenance.

Chapter 3

3.21A.4. A Market Participant requesting permission for Commissioning Tests must submit to System Management the following information at least 20 Business Days in advance of the start date of the proposed trial:

- (a) the name and location of the facility to be tested;
- (b) the date and commencement time of all Trading Intervals during which testing will be conducted; and
- (c) details of the tests to be conducted, including an indicative test program.

3.21A.5. Commissioning Test plans submitted by a Market Participant must represent the good faith intention of the Market Participant to conduct such Commissioning Test.

3.21A.6. Where a Market Participant no longer plans to conduct a Commissioning Test it must inform System Management as soon as practicable.

3.21A.7. System Management must accept a request for a Commissioning Test unless:

- (a) inadequate information is provided in the request; or
- (b) the conduct of the test at the proposed time would pose a threat to Power System Security or Power System Reliability.

3.21A.8. System Management must not show bias towards a Market Participant in regard to scheduling of Commissioning Tests.

3.21A.9. System Management must notify a Market Participant as to whether System Management has approved a Commissioning Test within 10 Business Days of receiving the notification described in clause 3.21A.4.

3.21A.10. Where System Management notifies a Market Participant that:

- (a) a Commissioning Test has not been approved it must provide an explanation for its decision.
- (b) a Commissioning Test has been approved then, subject to clause 3.21A.11, the Market Participant may proceed with that Commissioning Test.

3.21A.11. If having approved a Commissioning Test, System Management becomes aware that:

- (a) the conduct of the test at the proposed time would pose a threat to Power System Security or Power System Reliability, or in the case of a Facility returning to service after extended maintenance the return to service has been delayed, then it may delay the commencement of the Commissioning Test; or

Chapter 3

(b) the Commissioning Test is no longer required then it may revoke its approval of the Commissioning Test,

and must notify the Market Participant conducting the Commissioning Test of such delay or cancellation.

3.21A.12. In conducting a Commissioning Test a Market Participant must conform to the test plan approved by System Management.

3.21A.13. If a Market Participant conducting a Commissioning Test cannot conform to the test plan approved by System Management then it must inform System Management as soon as practicable.

3.21A.14. Where a Facility is subject to a Commissioning Test the Dispatch Schedule for that Facility during the period of the Commissioning Test is to reflect the energy produced by the facility.

Note that the previous clause is relevant primarily to IPP generation as the Electricity Generation Corporation is effectively settled at MCAP on what it produces anyway.

3.21A.15. System Management must document the procedure it follows in scheduling Commissioning Tests in the Power System Operation Procedure and System Management and Market Participants must follow that documented Market Procedure when planning and conducting Commissioning Tests.

Decommitment and Reserve Capacity Obligations

3.21B. Decommitment and Reserve Capacity Obligations

3.21B.1. Except where approval for a Planned Outage has been granted, or clause 7.9.6 applies, a Market Participant must seek permission from System Management before putting a Scheduled Generator holding Capacity Credits into a state where it will take more than four hours to re-synchronise the Scheduled Generator.

3.21B.2. A Market Participant must request from System Management the permission described in clause 3.21B.1 not less than two hours prior to the facility ceasing to be able to be re-synchronised within four hours, including in that request:

(a) the identity of the Scheduled Generator;

(b) the time at which the Market Participant wants to have the Scheduled Generator enter a state where it will take more than four hours to re-synchronise; and

(c) the first time after that in (b) at which the Scheduled Generator will be able to be resynchronised with four hours notice.

Chapter 3

3.21B.3. System Management must assess the request for permission, based on the information available to System Management at the time of the request, and applying the criteria set out in clause 3.21B.5.

3.21B.4. System Management must either approve or reject the request and inform the Market Participant of its decision as soon as practicable, but no later than one hour prior to the time described in clause 3.21B.2(b).

3.21B.5. System Management may only withhold the permission described in clause 3.21B.1 if:

- (a) the request for that permission is not in compliance with clause 3.21B.2 or the Power System Operation Procedure; or
- (b) granting permission would mean that System Management would be incapable of maintaining the Ready Reserve Standard.

3.21B.6. Where System Management informs a Market Participant that permission is not granted, then System Management and the Market Participant must use their best endeavours to find an alternative time for the Scheduled Generator to be put into a state where it will take more than four hours to re-synchronise the Scheduled Generator

3.21B.7. If System Management grants permission, then between the times between those stated in clause 3.21B.2(b) and 3.21B.2(c), or such alternative times as are mutually agreed in accordance with clause 3.21B.6, System Management must not require that Scheduled Generator to perform in accordance with its Reserve Capacity Obligations.

3.21B.8. System Management must document the procedure it follows granting permission in accordance with this clause 3.21B in the Power System Operation Procedure and System Management and Market Participants must follow that documented Market Procedure.

Settlement Data

3.22. Settlement Data

3.22.1. The IMO must provide the following information to the Settlement System for each Trading Month:

- (a) Capacity_LF as described in clause 3.13.1(aA);
- (b) [Blank]
- (c) Margin_Peak as described in clause 2.23.12(d)(i);
- (d) Margin_Off-Peak as described in clause 2.23.12(d)(ii);

Chapter 3

- (e) Capacity_R_Peak, the requirement for Spinning Reserve for Peak Trading Intervals assumed in forming Margin_Peak;
- (f) Capacity_R_Off-Peak, the requirement for Spinning Reserve for Off-Peak Trading Intervals assumed in forming Margin_Off-Peak;
- (fA) LFR as described in clause 3.13.1(aA)(i)(2);
- (g) Cost_LRD as described in clause 3.13.1(c); and
- (h) the compensation due to changed outage plans to be paid to a Market Participant for that Trading Month as determined in accordance with clause 3.19.12(e).

3.22.2. When System Management has entered into an Ancillary Service Contract with a Rule Participant, System Management must as soon as practicable and not less than 20 Business Days prior to the Ancillary Service Contract taking effect, provide the IMO with:

- (a) the identity of the Rule Participant;
- (b) the Ancillary Service contracted to be provided by the Rule Participant;
- (c) a unique identifier for the Ancillary Service Contract;
- (d) the form of settlement data that System Management will provide to the IMO for the Contracted Ancillary Service provided by the Rule Participant, where this data must be one of the formats allowed by clause 3.22.3.

3.22.3. System Management must provide the following information to the IMO for each Rule Participant holding an Ancillary Service Contract for a Trading Month by the date specified in clause 9.16.2(a):

- (a) the identity of the Rule Participant;
- (b) for each Ancillary Service Contract held:
 - i. the type of Ancillary Service where this can be one of:
 - 1. Spinning Reserve;
 - 2. Load Following;
 - 3. Load Rejection;
 - 4. System Restart; or
 - 5. Dispatch Support;
 - ii. for each Trading Interval of the Trading Month the quantity of Ancillary Service to a precision of 0.001 units (where no specific unit of measure will be assumed).
 - iii. either:

Chapter 3

1. a total monthly payment for the Ancillary Service in dollars and whole cents; or
2. a price in dollars and whole cents per unit of the quantity described in (ii) per Trading Interval.

4 Reserve Capacity Rules

The Reserve Capacity Cycle

4.1. The Reserve Capacity Cycle

4.1.1. This clause 4.1 sets out the timetable by which the key events described in this Chapter in respect of each Reserve Capacity Auction must occur. The events described below comprise a single Reserve Capacity Cycle, except where otherwise indicated. The Reserve Capacity Cycle will be repeated for each Reserve Capacity Auction.

4.1.1A. Clause 4.28B takes precedence over this clause 4.1 and events described in clause 4.28B are not required to comply with the timetable of this section 4.1 except where specified in clause 4.28B.

Clause 4.28B allows very small generators to be granted Capacity Credits outside of the normal process.

4.1.2. The first Reserve Capacity Auction is scheduled to be held in year 2005 with a single Reserve Capacity Auction to be held in each subsequent year.

4.1.3. Year 1 of a Reserve Capacity Cycle is the Calendar Year in which the Reserve Capacity Auction for that Reserve Capacity Cycle is scheduled to be held, while Year 4 is the final year of the Reserve Capacity Cycle. Year 1 of the first Reserve Capacity Cycle is 2005.

4.1.4. The IMO must advertise a Request for Expressions of Interest in accordance with clause 4.2.4 by 5 PM on or before:

- (a) 15 October 2004, in the case of the first Reserve Capacity Cycle; and

The intention is to run the first expression of interest by 4 October, but the latest allowable date has been set 10 days later to allow some contingency time.

- (b) 31 January of Year 1, in the case of subsequent Reserve Capacity Cycles.

This will be done by the IMO, except for the first Expressions of Interest, where it will be the Minister under clause 1.9, as the IMO will not have been established.

4.1.5. The IMO must allow potential Reserve Capacity providers to respond to the Request for Expressions of Interest in accordance with clause 4.2 until 5 PM of the first Business Day falling on or following:

- (a) 10 December 2004, in the case of the first Reserve Capacity Cycle; and
- (b) 1 May of Year 1, in the case of subsequent Reserve Capacity Cycles.

Chapter 4

This will be done by the IMO, except for the first Expressions of Interest, where it will be the Minister under clause 1.9, as the IMO will not have been established.

- 4.1.6. The IMO must publish a summary of the responses to its Request for Expressions of Interest in accordance with clause 4.2.7 by 5 PM of the first Business Day falling on or following:
- (a) 23 December 2004, in the case of the first Reserve Capacity Cycle; and
 - (b) 15 May of Year 1, in the case of subsequent Reserve Capacity Cycles.
- 4.1.7. The IMO must accept lodgement of applications for certification of Reserve Capacity for the Reserve Capacity Cycle in accordance with clause 4.9.1 from 9 AM of the first Business Day falling on or following:
- (a) 4 January 2005, in the case of the first Reserve Capacity Cycle; and
 - (b) 1 May of Year 1, in the case of subsequent Reserve Capacity Cycles.
- 4.1.8. The IMO must publish a Statement of Opportunities Report produced in accordance with the Long Term PASA process described in clause 4.5.11 by 5 PM of the first Business Day falling on or following 1 July of Year 1 of the relevant Reserve Capacity Cycle.
- 4.1.9. The IMO must release the Reserve Capacity Information Pack in accordance with clause 4.7.1 by 5 PM of the first Business Day falling on or following 1 July of Year 1 of the relevant Reserve Capacity Cycle.

The above information is about auction process etc. Those who respond to the EOI get it 2 weeks before it is published (next clause).

- 4.1.10. The IMO must publish on the Market Web Site the Reserve Capacity Information Pack in accordance with clause 4.7.2 by 5 PM of the first Business Day falling on or following 15 July of Year 1 of the relevant Reserve Capacity Cycle.
- 4.1.11. The IMO must cease to accept lodgement of applications for certification of Reserve Capacity for the Reserve Capacity Cycle in accordance with clause 4.9.1 from 5 PM of the last Business Day falling on or before 20 July of Year 1 of the Reserve Capacity Cycle.
- 4.1.12. The IMO must notify each applicant for certification of Reserve Capacity of the Certified Reserve Capacity to be assigned by 5 PM of the last Business Day on, or before, 5 August of Year 1 of the Reserve Capacity Cycle.
- 4.1.13. Each Market Participant must provide to the IMO any Reserve Capacity Security (in full) required in accordance with clause 4.13.1 not later than 5 PM of the last Business Day falling on or before:

Chapter 4

- (a) 10 August of Year 1 of the relevant Reserve Capacity Cycle if any of the Facility's Certified Reserve Capacity is specified to be traded bilaterally in accordance with clause 4.14.1(c); or
- (b) 29 August of Year 1 of the relevant Reserve Capacity Cycle if any of the Facility's Certified Reserve Capacity is specified to be offered into the Reserve Capacity Auction in accordance with clause 4.14.1(a) and where none of the Facility's Certified Reserve Capacity is specified to be traded bilaterally in accordance with clause 4.14.1(c).

4.1.14. Each Market Participant holding Certified Reserve Capacity for the Reserve Capacity Cycle must provide to the IMO notification in accordance with clause 4.14.1 as to how much of its Certified Reserve Capacity will be traded bilaterally and how much will be offered to the IMO in the Reserve Capacity Auction held in Year 1 of the relevant Reserve Capacity Cycle not later than 5 PM of the last Business Day falling on or before:

- (a) 9 September 2005, in the case of the first Reserve Capacity Cycle; and

Dates for the first Reserve Capacity Cycle have been set to be a month after they would be in later cycles, but have been adjusted so as not to fall on weekends or holidays.

- (b) 10 August of Year 1, in the case of subsequent Reserve Capacity Cycles.

4.1.15. By 5 PM of the first Business Day following the notification deadline specified in clause 4.1.14, the IMO must confirm to each Market Participant in accordance with clause 4.14.9 the amount of Certified Reserve Capacity that can be traded bilaterally from its Facilities.

4.1.16. The IMO must publish the information required by clauses 4.15.1 and 4.15.2 pertaining to whether or not a Reserve Capacity Auction is required by 5 PM of the last Business Day falling on or before:

- (a) 16 September 2005, in the case of the first Reserve Capacity Cycle; and
- (b) 18 August of Year 1, in the case of subsequent Reserve Capacity Cycles.

4.1.17. If a Reserve Capacity Auction proceeds, then the IMO must accept submission of Reserve Capacity Offers from Market Participants in accordance with clause 4.17.2:

- (a) from 9 AM of the first Business Day falling on or following:
 - i. 20 September 2005 of Year 1, in the case of the first Reserve Capacity Cycle; and
 - ii. 20 August of Year 1, in the case of subsequent Reserve Capacity Cycles; and
- (b) until 5 PM of the last Business Day falling on or before:

Chapter 4

- i. 29 September 2005, in the case of the first Reserve Capacity Cycle; and
- ii. 29 August of Year 1, in the case of subsequent Reserve Capacity Cycles.

4.1.18. If a Reserve Capacity Auction proceeds, then the IMO must

- (a) run the Reserve Capacity Auction on the first Business Day falling on or following:
 - i. 3 October of 2005, in the case of the first Reserve Capacity Cycle; and
 - ii. 1 September of Year 1, in the case of subsequent Reserve Capacity Cycles; and
- (b) must publish the results in accordance with clause 4.19.5 by 5 PM of that day.

4.1.19. Not earlier than the first Business Day following the Reserve Capacity Auction, the IMO must commence a review of the Maximum Reserve Capacity Price as required by clause 4.16.3 with the objective of completing the review, including consideration of public submissions in relation to that review, so as to allow a reasonable time for the Economic Regulation Authority to approve any proposed change in value and for that value to be implemented prior to the date and time specified in clause 4.1.4 that relates to the following Reserve Capacity Cycle.

4.1.20. Each Market Participant holding Certified Reserve Capacity to be traded bilaterally or which has been scheduled by the IMO in a Reserve Capacity Auction must provide to the IMO:

- (a) notification, in accordance with clause 4.20, of how many Capacity Credits each Facility will provide; and
- (b) notification of any Long Term Special Price Arrangements to be accepted in accordance with clause 4.22,

not later than 5 PM of the last Business Day falling on or before 20 December of Year 1 of the relevant Reserve Capacity Cycle.

4.1.21. Not later than 5 PM of the last Business Day falling on or before 23 December of Year 1 of a Reserve Capacity Cycle, the IMO must, in accordance with clause 4.13.10:

- (a) notify a Market Participant that has provided a Reserve Capacity Security for a Facility that the Reserve Capacity Security is no longer required; and
- (b) return any Reserve Capacity Security which was provided in the form of a cash deposit,

Chapter 4

in the event that the Market Participant does not hold Capacity Credits for the Facility to which the Reserve Capacity Security relates in the relevant Reserve Capacity Cycle.

The following clauses relate to setting the Individual Reserve Capacity Requirements of Market Participants which are used as the basis for allocating the costs of Reserve Capacity procured by the IMO.

4.1.22. For the first Reserve Capacity Cycle, the IMO must publish the date and time from which the initial Reserve Capacity Requirements for Market Customers will apply (which is the Initial Time as determined in accordance with clause 4.1.25), not later than 30 Business Days prior to the day on which the Initial Time occurs.

4.1.23. Each Market Customer must provide to the IMO the information described in clause 4.28.8 by:

- (a) in the case of the first Reserve Capacity Cycle, 5 PM on the Business Day being 15 Business Days prior to the day on which the Initial Time occurs; and

The “Initial Time” is defined in clause 4.1.25

- (b) in the case of a subsequent Reserve Capacity Cycle, 5 PM on the last Business Day falling on or before 20 August of Year 3 of that cycle.

4.1.24. The IMO must publish the initial Individual Reserve Capacity Requirement for each Market Customer in accordance with clause 4.28.7 by:

- (a) in the case of the first Reserve Capacity Cycle, 5 PM on the Business Day being 10 Business Days prior to the day on which the Initial Time occurs; and
- (b) in the case of a subsequent Reserve Capacity Cycle, by 5 PM on the last Business Day falling on or before 10 September of Year 3 of that cycle.

4.1.25. The initial Individual Reserve Capacity Requirement for a Market Customer is to apply from:

- (a) in the case of the first Reserve Capacity Cycle, the earlier of Energy Market Commencement and the start of the Trading Day commencing on 1 October 2007 (“**Initial Time**”); and
- (b) in the case of a subsequent Reserve Capacity Cycle, the start of the Trading Day commencing on 1 October of Year 3 of that cycle.

4.1.26. Reserve Capacity Obligations apply:

- (a) in the case of the first Reserve Capacity Cycle:
 - i. from the Initial Time, for Facilities that were commissioned before Energy Market Commencement;

- ii. from the Trading Day commencing on the scheduled date of commissioning, as specified in accordance with clause 4.10.1(c)(iii)(7), for Scheduled Generators and Non-Scheduled Generators commissioned between Energy Market Commencement and 30 November 2007, inclusive; and
 - iii. from the Trading Day commencing on 1 October 2007 for Interruptible Loads, Curtailable Loads or Dispatchable Loads commissioned after Energy Market Commencement; and
- (b) in the case of subsequent Reserve Capacity Cycles:
- i. from the Trading Day commencing on 1 October of Year 3, for Facilities that were commissioned as at the scheduled time of the Reserve Capacity Auction for the Reserve Capacity Cycle as specified in clause 4.1.18(a) or for Facilities which have provided Capacity Credits in one or both of the two previous Reserve Capacity Cycles; and
 - ii. from the Trading Day commencing on the scheduled date of commissioning, as specified in accordance with clause 4.10.1(c)(iii)(7), for Facilities commissioned between 1 August of Year 3 and 30 November of Year 3.

The intention is that for subsequent Reserve Capacity Cycles other than the first Reserve Capacity Cycle a participant with a Facility commissioned in August would be paid for periods between commissioning and 1 October. The price paid will be the price that would apply to that capacity from 1 October. For the period leading up to 1 October a Short Term Special Price Arrangement should apply. Additions to the short term special price arrangement clause and capacity credit clause will be required to reflect this. However these amendments are not required prior to the second Reserve Capacity Cycle.

4.1.27. The IMO must in accordance with clause 4.13.10 notify a Market Participant that has provided a Reserve Capacity Security for a Facility that the Reserve Capacity Security is no longer required, and return any cash deposit, within five Business Days of the first day that the Facility to which the Reserve Capacity Security relates is considered by the IMO to be in commercial operation and capable of meeting its Reserve Capacity Obligations.

4.1.28. Every month between 1 October of Year 3 and 30 September of Year 4 of a Reserve Capacity Cycle:

- (a) the IMO must update the values of each Market Participant's Individual Reserve Capacity Requirement in accordance with clause 4.28.11; and
- (b) the IMO must publish updated Individual Reserve Capacity Requirements no later than by 5:00 PM on the Business Day being five Business Days prior to the commencement of the Trading Month from which the updated Individual Reserve Capacity Requirements will apply.

Chapter 4

4.1.29. The Reserve Capacity Price and Monthly Reserve Capacity Price for a Reserve Capacity Cycle are applicable between the following time and dates:

- (a) from:
 - i. in the case of the first Reserve Capacity Cycle, the start of the Trading Day commencing on the earlier of Energy Market Commencement and the start of the Trading Day commencing on 1 October 2007;
 - ii. in the case of subsequent Reserve Capacity Cycles, the start of the Trading Day commencing on 1 October of Year 3 of the relevant cycle; and
- (b) to the end of the Trading Day ending on 1 October of Year 4 of the relevant cycle.

4.1.30. The Reserve Capacity Obligations for a Facility arising through holding Capacity Credits for a Reserve Capacity Cycle cease to apply from:

- (a) subject to paragraph (b), the completion of the Trading Day ending on 1 October of Year 4 of the relevant Reserve Capacity Cycle; and
- (b) the completion of the Trading Day ending on the scheduled date of decommissioning, as specified in accordance with clause 4.10.1(d), for Facilities decommissioned between 1 August of Year 4 of the relevant Reserve Capacity Cycle and 1 October of Year 4.

4.1.31. The description of an event in this clause is for the purpose of identifying where it fits into the Reserve Capacity Cycle, and does not affect the interpretation of the relevant provisions of this Chapter.

4.1.32. The IMO may modify or extend a date or time set under this clause 4.1 (except the dates and times set by clause 4.1.18, 4.1.26, 4.1.29 and 4.1.30). If the IMO extends a date or time under this clause 4.1.32, then it must publish notice of the modified or extended time or date on the Market Web Site and the modified or extended date or time takes effect for the purposes of these Market Rules.

The Reserve Capacity Expression of Interest

4.2. The Reserve Capacity Expression of Interest Process

Note: Until the IMO is created, the Regulations contemplate that the Minister may perform functions of the IMO. The IMO will be established prior to the start of the certification or reserve capacity on 4 January 2005. The expression of interest phase is intended to take place prior to the establishment of the IMO and therefore the first Expression of Interest will be undertaken by the Minister.

4.2.1. The purpose of the Reserve Capacity Expression of Interest is to provide the IMO with an indication from existing and potential new Market Participants of the amount

Chapter 4

of new generation and new Demand Side Management capacity they are willing to offer to make available as Reserve Capacity.

- 4.2.2. The IMO must prepare a Request for Expressions of Interest which contains information which includes, the information described in clause 4.3.1.
- 4.2.3. The Request for Expressions of Interest is to be made available:
- (a) on a web-site;
 - (b) to any person on application to the IMO.
- 4.2.4. By the date and time specified in clause 4.1.4, the IMO must have advertised the Request for Expressions of Interest, including how to obtain the Request for Expression of Interest:
- (a) on a web-site; and
 - (b) in local and national media which, in the opinion of the IMO, is likely to be seen by potential suppliers of Reserve Capacity.
- 4.2.5. At its discretion, the IMO may continue to advertise and promote the Request for Expression of Interest until the deadline for submissions of Expression of Interest specified in clause 4.2.6.
- 4.2.6. Expressions of Interests must be provided to the IMO by the time and date specified in clause 4.1.5 and must contain the information described in clause 4.4.1.
- 4.2.7. By the date and time specified in clause 4.1.6, the IMO must publish the following information:
- (a) the number of Expression of Interests received;
 - (b) based on the Expression of Interests, the additional Reserve Capacity potentially available, categorised as:
 - i. capacity associated with Facilities that are under construction; and
 - ii. capacity associated with Facilities that are yet to commence being constructed, where this capacity is to be further categorised between new Facilities for which:
 - 1. an offer by the relevant Network Operator to enter into an Arrangement for Access (“**Access Offer**”) has been made and all necessary Environmental Approvals granted;
 - 2. applications for both Access Offers and Environmental Approvals have been made and one or both are being processed;
 - 3. no Access Offer has been applied for or some or all Environmental Approvals have not been applied for;

- (c) based on the Expression of Interests, the additional Reserve Capacity potentially available categorised as:
 - i. capacity associated with Intermittent Generators;
 - ii. capacity associated with non-Intermittent Generators;
 - iii. capacity associated with Demand Side Management; and
- (d) based on the Expression of Interests, the additional Reserve Capacity potentially available categorised based on fuel type and back-up fuel options;
- (e) the IMO's estimate of the existing capacity eligible to be assigned Certified Reserve Capacity in the SWIS; and
- (f) the preliminary Reserve Capacity Requirement for the Reserve Capacity Cycle to which the Expression of Interest relates that was included in the Request for Expression of Interest.

These last two clauses have been added because the information contained in them is required for people to assess the adequacy of the response to the Expression of Interest. It is true that the information is published elsewhere, but it should still be included in the summary.

4.3. Information to be Included in Requests for Expression of Interest

- 4.3.1. A Request for Expression of Interest for a Reserve Capacity Cycle must include the following information:
- (a) a request for a response by interested parties not later than the relevant time specified in clause 4.1.5;
 - (b) the preliminary Reserve Capacity Requirement for the Reserve Capacity Cycle determined in accordance with clause 4.6.3;

While not listed, it is intended that information on the likely Availability Curves will be included in the Request for Expressions of Interest for the first auction, however, the information presented may be simpler than required for Availability Curves.

- (c) for each of the three previous Reserve Capacity Cycles (if applicable):
 - i. the Reserve Capacity Requirement determined in accordance with clause 4.6.1;
 - ii. the Availability Curve referred to in clause 4.5.10(e) applicable to that Reserve Capacity Cycle;
 - iii. the Reserve Capacity Auction Requirement for any Reserve Capacity Auction held;
 - iv. the number of Capacity Credits acquired by the IMO;
 - v. the Maximum Reserve Capacity Price;

Chapter 4

- vi. the Reserve Capacity Price; and
- vii. the Monthly Reserve Capacity Price;

There may not be a Reserve Capacity Price if no Reserve Capacity Auction was held, but there will always be a Monthly Reserve Capacity Price. If no auction is held, the Monthly Reserve Capacity Price is set to 85% of the Maximum Reserve Capacity Price divided by 12.

- (d) the number of Capacity Credits which the IMO expects to be traded bilaterally;

The above clause is intended to capture the fact that some Capacity Credits for a Reserve Capacity Cycle may have been certified even before the Expression of Interest. Further the **Electricity Generation Corporation** is required under Market Power Mitigation strategies to use its own generating capacity to cover the capacity requirements of its **peak bilateral energy trades during the previous Hot Season** on a bilateral basis. Thus while at the time of the Expression of Interest the formal process for notifying of bilateral trades will not have occurred for that Reserve Capacity Cycle, the party conducting the Expression of Interest will know what actions the Market Power Mitigation strategy require.

- (e) the amount of capacity expected to be required from new Facilities, where this figure is based on the difference between the preliminary Reserve Capacity Requirement for the Reserve Capacity Cycle as determined in accordance with clause 4.6.3 and the latest information available to the IMO as to the aggregate available capacity for the SWIS during the period to which the Reserve Capacity Requirement relates;

It is provisionally expected that the amount of new capacity required in the first auction will be 325 MW. This 325 MW figure includes provision for the retirement of Muja A/B.

- (f) the then current Maximum Reserve Capacity Price;
- (g) a brief summary of the eligibility requirements for Reserve Capacity to be certified under clause 4.11;
- (h) information on how to obtain the Market Rules from a web-site ;
- (i) the following information on timetables and processing times for the Reserve Capacity Cycle:
 - i. the date and time from which the lodgement of applications for certification of Reserve Capacity will be allowed;
 - ii. the date and time by which applications for certification of Reserve Capacity must be lodged;
 - iii. the date and time that applicants for Certified Reserve Capacity will be notified of the Certified Reserve Capacity assigned;

- iv. the date and time by which a Market Participant which holds Certified Reserve Capacity must notify the IMO as to how much of that capacity will be traded bilaterally, offered into a Reserve Capacity auction, or not be made available to the market in accordance with clause 4.14.1;
- v. the date and time by which the IMO will announce whether the Reserve Capacity Auction will be cancelled;
- vi. the date and time from which the lodgement of Reserve Capacity Offer submissions will be allowed;
- vii. the last date and time at which lodgements of Reserve Capacity Offer will be allowed;
- viii. the date and time the Reserve Capacity Auction results will be published; and
- ix. the last date and time by which:
 - 1. Long Term Special Price Arrangements can be accepted by Market Participants; and
 - 2. Market Participants can inform the IMO of the Facilities which will provide Capacity Credits;
- (j) the information required to be included in an Expression of Interest and the format in which that information is to be presented;
- (k) the closing date and time for submission of Expressions of Interest; and
- (l) who to contact with questions and responses to the Expression of Interest, including that person's contact details.

4.4. Information to be Included in Expression of Interests

4.4.1. An Expression of Interest for a Reserve Capacity Cycle must include the following information:

- (a) the identity of the person proposing to provide Reserve Capacity and contact details;
- (b) for each Facility covered by the Expression of Interest, its name and location and whether it is:
 - i. an Intermittent Generator;
 - iA. a non-Intermittent Generator not serving Intermittent Load;
 - ii. a non-Intermittent Generator serving Intermittent Load; or
 - iii. a form of Demand Side Management;
- (c) the maximum Reserve Capacity anticipated to be available from each Facility;
- (cA) for non-Intermittent Generators serving Intermittent Load, the maximum capacity anticipated to be required to serve the Intermittent Load;

- (d) for each Facility:
- i. the expected earliest date that the Facility will be able to be fully operational;
 - ii. the status of any applications for Access Offers in respect of that Facility;
 - iii. the status of any applications for Environmental Approvals required in respect of that Facility;
 - iv. details of the type and quantity of fuel expected to be available to that Facility ;and
 - v. the hours during a typical week when the Facility will not be available to be dispatched due to staffing restrictions or other factors.

This last clause will alert the IMO to restrictions. These restrictions are accounted for in the procedure and may materially impact on the certification of the Facility.

The Long Term SWIS Capacity Requirements

4.5. Long Term Projected Assessment of System Adequacy

4.5.1. The Long Term PASA Study must be performed annually by the IMO and considers each of the years in the Long Term PASA Study Horizon.

4.5.2. The Long Term PASA Study must take into account:

- (a) demand growth scenarios, including peak and annual energy requirements;
- (b) expected Demand Side Management capabilities and taking into account clause 4.28.10;

Clause 4.28.10 relates to peak shaving by retailers to reduce their Individual Reserve Capacity Requirements.

- (c) generation capacity expected to be available, including details on seasonal capacities, Ancillary Service capabilities, long duration outages and, for Non-Scheduled Generators, production profiles;
- (d) expected transmission network capabilities allowing for expansion plans, losses and constraints; and
- (e) the capacity described in clause 4.5.2A.

4.5.2A. The IMO must determine an estimate of the Reserve Capacity required to cover the forecast cumulative needs of Intermittent Loads such that:

- (a) this Reserve Capacity estimate is in addition to the Reserve Capacity required to satisfy the Planning Criterion in the situation where there were no Intermittent Loads; and

Chapter 4

- (b) this Reserve Capacity estimate must be set by the IMO to equal the sum over all expected Intermittent Loads of their forecast maximum possible Intermittent Load levels multiplied by:
- i. the ratio of:
 1. the Reserve Capacity Target for the relevant Capacity Year as described in clause 4.5.10(b)(i); and
 2. the expected peak demand for the relevant Capacity Year as described in clause 4.5.10(b)(ii);
 - ii. minus one.

In the above clause, clause (a) means that capacity required to serve the Planning Criterion for regular loads cannot count as capacity to cover Intermittent Loads. The ratio in clause (b) is just the reserve margin for the year (e.g. 115%) and clause (b) ensures that the Reserve Capacity associated with any Intermittent Load will equal the capacity margin (e.g. 15%) required for a normal Load beyond the capacity required to cover the load itself. Note that clause (b) may force some iteration into the process, as the amount of Reserve Capacity required for Intermittent Loads will influence the values specified in clause 4.5.10(b).

4.5.3. The IMO must notify Rule Participants of the information that it requires from them in the areas described in clause 4.5.2, in respect of each year of the Long Term PASA Study Horizon, no later than 1 April of Year 1 of the relevant Reserve Capacity Cycle.

4.5.3A. The information requested by the IMO under clause 4.5.3 must include a request for Market Customers to provide the following information pertaining to Intermittent Loads and Loads that are expected to be registered and operating as Intermittent Loads during the second Capacity Year commencing during the Long Term PASA Study Horizon:

The Long Term PASA Study Horizon begins on 1 October of the year following a Reserve Capacity auction, so the Capacity Year applicable to that auction is the second Capacity Year of the Long Term PASA Study Horizon.

The information requested is for forecasting purposes only and is not binding on Intermittent Loads.

- (a) the amount of capacity required to serve that Load in the event of a failure of on-site generation where this amount of capacity cannot exceed the greater of:
- i. either:
 1. for an existing Intermittent Load, the maximum allowed level of Intermittent Load specified in Standing Data for that Intermittent Load at the time of providing the data; or

2. for an Intermittent Load that is yet to be registered with the IMO, zero; and
 - ii. the Contractual Maximum Demand associated with that Intermittent Load to apply during the Capacity Year to which the nomination relates. The Market Customer must provide evidence to the IMO of this Contractual Maximum Demand level unless the IMO has previously been provided with that evidence; and
- (b) for each Intermittent Load that is yet to be registered with the IMO:
 - i. the location of the Load;
 - ii. evidence that the Load can be expected to satisfy the requirements to be registered as an Intermittent Load during the second Capacity Year within the Long Term PASA Study Horizon; and
 - iii. the expected firm MW capacity and location of any generation system to serve that Intermittent Load in accordance with clause 2.30B.2(a) that is to be located at a different connection point to the Intermittent Load.

4.5.4. Rule Participants must provide the data requested by the IMO in accordance with clause 4.5.3 within 15 Business Days from the date of that request.

Rule Participants include Network Operators, who would support the IMO by providing information on loads and generation as well as transmission, and any Market Participant whose facilities are yet to commence operation.

4.5.5. The IMO may request from persons who are not Rule Participants information in the areas described in clause 4.5.2 in respect of each year of the Long Term PASA Study Horizon.

4.5.6. The IMO must review the information provided to it in accordance with clause 4.5.4 and as a result of a request under clause 4.5.5, and where necessary, seek clarifications.

4.5.7. The IMO must treat all information provided to it in accordance with clauses 4.5.4, 4.5.5 and 4.5.6 as confidential except where the provider has granted permission for its release or as otherwise provided under these Market Rules. However, the IMO may release any such information as part of an unidentifiable component of an aggregate number in a Statement of Opportunities Report.

4.5.8. Where information provided to the IMO in accordance with clauses 4.5.4, 4.5.5 and 4.5.6 is not adequate or is insufficient for the purpose for which it is required, the IMO may make its own estimate and use that estimate in place of information provided in accordance with clauses 4.5.4, 4.5.5 and 4.5.6.

Chapter 4

4.5.9. The Planning Criterion to be used by the IMO in undertaking a Long Term PASA study is there should be sufficient available capacity in each Capacity Year during the Long Term PASA Planning Horizon to:

- (a) meet the forecast peak demand (including transmission losses and allowing for Intermittent Loads) supplied through the SWIS even after the outage of the largest generation unit and while maintaining the Minimum Frequency Keeping Capacity for normal frequency control. The forecast peak demand should be calculated to a probability level that the forecast would not be expected to be exceeded in more than one year out of ten; and
- (b) limit expected energy shortfalls to 0.002% of annual energy consumption (including transmission losses).

4.5.10. The IMO must use the information assembled to:

- (a) assess the extent to which the anticipated installed generation capacity and Demand Side Management capacity is capable of satisfying the Planning Criterion, identifying any capacity shortfalls in each Relevant Year in the Long Term PASA Study Horizon, for each of the following scenarios;
 - i. median peak demand assuming low demand growth;
 - ii. one in ten year peak demand assuming low demand growth;
 - iii. median peak demand assuming expected demand growth;
 - iv. one in ten year peak demand assuming expected demand growth;
 - v. median peak demand assuming high demand growth;
 - vi. one in ten year peak demand assuming high demand growth,where the low, expected, and high demand growth cases reflect demand changes stemming from different levels of economic growth, with these being temperature adjusted to produce the one in ten year peak demand cases.
- (b) forecast the Reserve Capacity Target and corresponding expected peak demand for each Capacity Year during the Long Term PASA Study Horizon, where:
 - i. the Reserve Capacity Target for a Capacity Year is the capacity required to meet the Planning Criterion in that year under the scenario described in paragraph (a)(iv); and
 - ii. the expected peak demand in that year is the peak demand under the scenario described in paragraph (a)(iv);
- (c) identify and assess any potential capacity shortfalls isolated to a sub-region of the SWIS resulting from expected restrictions on transmission capability or other factors;

Chapter 4

- (d) identify any potential transmission, generation or demand side capacity augmentation options to alleviate capacity shortfalls identified in paragraphs (a) and (c); and
- (e) develop a two dimensional curve for each of the 2nd and 3rd Capacity Years of the Long Term PASA Study Horizon describing the information referred to in clause 4.5.12 (“**Availability Curve**”).

The results for year 3 are used in running the auction with respect to offers from different Availability Classes. The results for year 2 provide a check as to the adequacy of capacity already procured to meet the year 2 Capacity Requirements.

4.5.11. The IMO must publish the Statement of Opportunities Report for a Reserve Capacity Cycle by the date specified in clause 4.1.8.

4.5.12. An Availability Curve for a Capacity Year is to contain the following information:

- (a) the forecast capacity, in MW, required for more than 24 hours per year, 48 hours per year, 72 hours per year and 96 hours per year;
- (b) the minimum capacity required to be provided by generation capacity if Power System Security and Power System Reliability is to be maintained. This minimum capacity is to be set at a level such that if:
 - i all Demand Side Management capacity (excluding Interruptible Load used to provide Spinning Reserve to the extent that it is anticipated to provide Certified Reserve Capacity), were activated during the Capacity Year so as to minimise the peak demand during that year; and
 - ii the Planning Criterion and the criteria for evaluating Outage Plans set out in clause 3.18.11 were to be applied to the load scenario defined by (i), then

it would be possible to satisfy the Planning Criterion and the criteria for evaluating Outage Plans set out in clause 3.18.11, as applied in paragraph (ii), using, to the extent that the capacity is anticipated to provide Certified Reserve Capacity, the anticipated installed generating capacity, the anticipated Interruptible Load capacity available as Spinning Reserve and, to the extent that further generation capacity would be required, an appropriate mix of generation capacity to make up that shortfall; and

This minimum capacity constraint is intended to ensure that the system does not schedule so much DSM capacity that generation capacity is so low that it is impossible to schedule maintenance of those generators. For instance, if the system carried enough DSM to cover the peak 96 hours then only about 85% of the capacity requirements would be covered by generators (instead of the current 97%). If the pool of generators were to shrink, it would be more difficult to maintain capacity while generators are undergoing maintenance.

Chapter 4

Note that the intention of this limit is not to unnecessarily restrict DSM sources.

- (c) the capacity associated with each Availability Class where:
 - i. the capacity quantity associated with Availability Class 4 is the Reserve Capacity Target for the Capacity Year less the greater of the quantity specified under paragraph (b) and the quantity specified under paragraph (a) as being required for more than 48 hours per year;
 - ii. the capacity quantity associated with Availability Class 3 is:
 - 1. the Reserve Capacity Target for the Capacity Year less the greater of the quantity specified under paragraph (b) and the quantity specified under paragraph (a) as being required for more than 72 hours per year; less
 - 2. the capacity quantity associated with Availability Class 4;
 - iii. the capacity quantity associated with Availability Class 2 is:
 - 1. the Reserve Capacity Target for the Capacity Year less the greater of the quantity specified under paragraph (b) and the quantity specified under paragraph (a) as being required for more than 96 hours per year; less
 - 2. the total capacity quantity associated with Availability Class 3 or Availability Class 4;
 - iv. the capacity quantity associated with Availability Class 1 is:
 - 1. the Reserve Capacity Target for the Capacity Year; less
 - 2. the total capacity quantity associated with Availability Class 2, Availability Class 3 or Availability Class 4;

4.5.13. The Statement of Opportunities Report must include:

- (a) the input information assembled by the IMO in performing the Long Term PASA study including, for each Capacity Year of the Long Term PASA Study Horizon:
 - i. the demand growth scenarios used;
 - ii. the generation capacities of each generation Registered Facility;
 - iii. the generation capacities of each committed generation project;
 - iv. the generation capacities of each probable generation project;
 - v. the Demand Side Management capability and availability;
 - vA. the amount of Reserve Capacity forecast to be required to serve the aggregate Intermittent Load;

Chapter 4

- vi. the assumptions about transmission network capacity, losses and network and security constraints that impact on study results; and
- vii. a summary of the methodology used in determining the values and assumptions specified in (i) to (vi), including methodological changes relative to previous Statement of Opportunities Reports;

The peak demand figures described in (b) are used in the methodology described in Appendix 5.

- (b) the Reserve Capacity Target for each Capacity Year of the Long Term PASA Study Horizon;
- (c) the amount by which the installed generation capacity plus the Demand Side Management available exceeds or falls short of the Reserve Capacity Target for each Capacity Year and each demand growth scenario considered in the study;
- (d) the extent to which localised supply restrictions will exist while satisfying the Reserve Capacity Target for each Capacity Year and each demand growth scenario considered in the study;
- (e) a statement of potential generation, demand side and transmission options that would alleviate capacity shortfalls relative to the Reserve Capacity Target and to capacity requirements in sub-regions of the SWIS; and
- (f) the Availability Curve for the 2nd and 3rd Capacity Years of the Long Term PASA Study Horizon.

4.5.14. The IMO must document the procedure it follows in conducting the Long Term PASA and reviews under clause 4.5.15 in the Reserve Capacity Procedure and Rule Participants, including the IMO, must follow that documented Market Procedure in the conduct of the Long Term PASA study and the review under clause 4.5.15.

4.5.15. From time to time, and at least once in every five year period starting from Energy Market Commencement, the IMO must conduct a review of the Planning Criterion and the process by which it forecasts SWIS peak demand. This review must include:

- (a) a review of the technical analysis; and
- (b) a cost-benefit study on the effects on stakeholders of a variety of levels of generation adequacy.

4.5.16. In conducting a review under clause 4.5.15, the IMO must invite submissions in accordance with the Reserve Capacity Procedure on the performance of the Planning Criterion and the process by which it forecasts SWIS peak demand from Rule Participants and take any submissions into account in the review.

Chapter 4

- 4.5.17. In accordance with the Reserve Capacity Procedure, the IMO must make available a draft of the report described in clause 4.5.18 to Rule Participants for comment and invite submissions on the draft report.
- 4.5.18. After concluding the review described in clause 4.5.15, the IMO must publish a final report containing:
- (a) issues identified by the IMO;
 - (b) assumptions made by the IMO in undertaking the review;
 - (c) submissions received by the IMO from Rule Participants in accordance with clause 4.5.16;
 - (d) the IMO's responses to the issues raised in those submissions;
 - (e) the results of the technical and cost-benefit studies;
 - (f) the submissions on the draft report received by the IMO from Rule Participants in accordance with clause 4.5.17;
 - (g) the IMO's responses to the issues raised in those submissions; and
 - (h) any recommended changes to the Planning Criterion.
- 4.5.19. Where the IMO finds that a change to the process by which it forecasts SWIS peak demand would be beneficial in light of the Wholesale Market Objectives, it must:
- (a) make a Rule Change Proposal to implement the change; and/or
 - (b) make a Procedure Change Proposal to implement the change.
- 4.5.20. If the IMO contracts with a third party to conduct the analysis required under this clause 4.5, then:
- (a) the IMO must ensure that the third party is familiar with the methodology employed in conducting the analysis required under this clause 4.5 in previous years; and
 - (b) the IMO must approve any variations in the process to be used by that third party where variations may only be accepted if not inconsistent with the requirements specified in the Market Rules or the Reserve Capacity Procedure.

4.6. Reserve Capacity Requirements

- 4.6.1. The Reserve Capacity Requirement for a Reserve Capacity Cycle is the Reserve Capacity Target for the Capacity Year commencing on 1 October of Year 3 of the Reserve Capacity Cycle as reported in the Statement of Opportunities Report for that Reserve Capacity Cycle.

For the first Reserve Capacity Cycle, Year 1 is 2005 so the Reserve Capacity Requirement is the Capacity Target from 1 October of 2007, as reported in the 2005 Statement of Opportunities Report.

- 4.6.2. The expected peak demand corresponding to the Reserve Capacity Requirement is the forecasted value determined in accordance with clause 4.5.10(b)(ii) for the Capacity Year commencing on 1 October of Year 3 of the Reserve Capacity Cycle.
- 4.6.3. The preliminary Reserve Capacity Requirement for a Reserve Capacity Cycle to be included in the relevant Request for Expression of Interest is:
- (a) for the first Reserve Capacity Cycle is 3,862 MW; and
 - (b) for subsequent Reserve Capacity Cycles, the Reserve Capacity Target for the Capacity Year commencing on 1 October of Year 3 of the Reserve Capacity Cycle as reported in the Statement of Opportunities Report for the preceding Reserve Capacity Cycle.

Certification of Reserve Capacity

4.7. The Reserve Capacity Information Pack

- 4.7.1. By the time and date specified in clause 4.1.9, the IMO must release the Reserve Capacity Information Pack for a Reserve Capacity Cycle to those who provided Expressions of Interest to the IMO in accordance with clause 4.2.6 for that Reserve Capacity Cycle.
- 4.7.2. By the time specified in clause 4.1.10, the IMO must publish the Reserve Capacity Information Pack for a Reserve Capacity Cycle on the Market Web Site.
- 4.7.3. The Reserve Capacity Information Pack for a Reserve Capacity Cycle must include the following information:
- (a) the Reserve Capacity Requirement for the Reserve Capacity Cycle, as determined in accordance with clause 4.6.1;
 - (b) an explicit description of the Availability Curve to be used in restricting the amount of Reserve Capacity only available for a limited number of hours per year that can be traded bilaterally in accordance with clause 4.14.9, or scheduled in the Reserve Capacity Auction in accordance with clause 4.19.1; and

This Availability Curve is used to limit the amount of Reserve Capacity that is only available for a few hours per year that can be used to cover the Reserve Capacity Requirement. After all, if we need 3000 MW of capacity, it does not help to have 3000 MW of Reserve Capacity that is only available for 1 hour per year.

- (c) instructions as to how to obtain from the Market Web Site a copy of:

- i. the Request for Expression of Interest; and
 - ii. the report described in clause 4.2.7,
- for the Reserve Capacity Cycle.

4.8. Who Can Apply for Certification of Reserve Capacity

4.8.1. Subject to clause 4.8.2, a Market Participant may apply for certification of the amount of Reserve Capacity which can be provided by a Facility if:

- (a) the Facility is a Registered Facility other than a Network; or
- (b) the Facility is not a Registered Facility but the Market Participant intends to have the Facility registered as a Registered Facility other than a Network by the commencement date of the Reserve Capacity Obligations for the relevant Reserve Capacity Cycle as specified in clause 4.1.26.

4.8.2. For the first Reserve Capacity Cycle, Western Power may not apply for certification of Reserve Capacity for its generation systems, with the Certified Reserve Capacity and associated Reserve Capacity Obligations for those Facilities instead being assigned and set in accordance with clauses 4.11.7 and 4.12.5.

This does not preclude Western Power from registering DSM options.

4.8.3. A Market Customer may apply for the certification of Demand Side Programme including Loads at different locations as a Curtailable Load subject to the following conditions and provisions:

- (a) No Intermittent Load may be included in the Demand Side Programme.
- (b) The Loads comprising the Demand Side Programme must be registered as Curtailable Loads if they are to count towards satisfying the relevant Reserve Capacity Obligations of the Demand Side Program and must not have been separately awarded Capacity Credits.
- (c) As the Loads comprising the Demand Side Program are registered, the IMO must assign Certified Reserve Capacity and Reserve Capacity Obligations to those Facilities and must correspondingly reduce the Certified Reserve Capacity and Reserve Capacity Obligations associated with the Demand Side Programme during the time those Facilities are registered.
- (d) After accounting for the modifications in (c), if at any time a Market Customer has Reserve Capacity Obligations associated with its Demand Side Programme then, for settlement purposes, the Demand Side Programme must be treated by the IMO as a Facility that has failed to satisfy its Reserve Capacity Obligations.

4.9. Process for Applying for Certification of Reserve Capacity

4.9.1. Applications for certification of Reserve Capacity:

Chapter 4

- (a) for the current Reserve Capacity Cycle may be lodged with the IMO from the date and time specified in clause 4.1.7 and until the time specified in clause 4.1.11; and
- (b) for a future Reserve Capacity Cycle may be lodged with the IMO at any time prior to the date and time specified in clause 4.1.7 for the Reserve Capacity Cycle to which the application relates.

The rules now allow people to apply for certified Reserve Capacity for future Reserve Capacity cycles, where these will be conditional on meeting requirements. This certification must occur in the normal annual window for certification as the IMO may only have the resources available to perform certification during those periods.

- 4.9.2. Only the Market Participant which has registered a Facility, or which intends to register a Facility, may apply for certification of Reserve Capacity in respect of that Facility.
- 4.9.3. A Market Participant applying for certification of Reserve Capacity:
 - (a) must provide to the IMO, in the format specified in the Reserve Capacity Procedure, the data specified in clause 4.10.1;
 - (b) in addition, **must**, in the case of application for certification of Reserve Capacity for an Intermittent Generator that is yet to enter service, provide to the IMO the report described in clause 4.10.3; and
 - (c) in the case of an application for certification for a future Reserve Capacity Cycle, an Application Fee to cover the cost of processing the application.
- 4.9.4. Applications for certification of Reserve Capacity must be made in the form prescribed by IMO by mail or e-mail.
- 4.9.5. If the IMO assigns Certified Reserve Capacity to a Facility for a future Reserve Capacity Cycle under clause 4.11 ("**Conditional Certified Reserve Capacity**"):
 - (a) the Conditional Certified Reserve Capacity is conditional upon the information included in the application for Certified Reserve Capacity remaining correct as at the date and time specified in clause 4.1.11 for that future Reserve Capacity Cycle
 - (b) the Market Participant holding the Conditional Certified Reserve Capacity must, in accordance with clauses 4.9.1 and 4.9.3, re-lodge an application for Certified Reserve Capacity with the IMO between the date and time specified in clause 4.1.7 and the time specified in clause 4.1.11 for that future Reserve Capacity Cycle;
 - (c) if the IMO is satisfied that the application re-lodged in accordance with paragraph (b) is consistent with the information upon which the Conditional Certified Reserve Capacity was assigned and is correct, then the IMO must confirm:

- i. the Certified Reserve Capacity;
 - ii. the Reserve Capacity Obligations Quantity; and
 - iii. the Reserve Capacity Security levels,
- that were previously conditionally assigned, set or determined by the IMO, subject to the Certified Reserve Capacity for an Intermittent Generator being assigned in accordance with clause 4.11.1(d) or 4.11.1(e); and
- (d) if the application re-lodged in accordance with paragraph (b) is found by the IMO to be inaccurate or is not consistent with the information upon which the Conditional Certified Reserve Capacity was assigned, then the IMO must process the application without regard for the Conditional Certified Reserve Capacity.
- 4.9.6. The IMO must notify an applicant for certification of Reserve Capacity of receipt of the application within one Business Day of receipt.
- 4.9.7. If a Market Participant fails to receive notification of receipt from the IMO in accordance with clause 4.9.6, then it must contact the IMO and arrange for re-submission of the information prior to the time and date specified in clause 4.1.11.
- 4.9.8. The IMO must notify applicants for certification of Reserve Capacity for:
- (a) the current Reserve Capacity Cycle, of the quantity of the Certified Reserve Capacity assigned to, and the initial Reserve Capacity Obligation Quantity set for, each Facility covered by the application, by the date and time specified in clause 4.1.12;
 - (b) a future Reserve Capacity Cycle, of the quantity of Conditional Certified Reserve Capacity assigned to, and the initial Reserve Capacity Obligation Quantity set for, each Facility covered by that application within 90 days of the IMO receiving the application.
- 4.9.9. If the IMO assigns Certified Reserve Capacity to a Facility in respect of a Reserve Capacity Cycle, the IMO must advise the applicant:
- (a) of the amount of Certified Reserve Capacity assigned to the Facility in respect of the Reserve Capacity Cycle, as determined in accordance with clause 4.11 or clause 4.9.5(c) (as applicable);
 - (b) of the initial Reserve Capacity Obligations Quantity set for the Facility, as determined in accordance with clause 4.12 or clause 4.9.5(c) (as applicable);
 - (c) of any Reserve Capacity Security required as a condition of a Market Participant holding the Certified Reserve Capacity, as determined in accordance with clause 4.13.1 or clause 4.9.5(c) (as applicable);
 - (d) in the case of Conditional Certified Reserve Capacity, that the certification is subject to the conditions in clause 4.9.5(a) and (b); and

Chapter 4

- (e) the calculations upon which the IMO's determinations are based.

4.9.10. The IMO must document the procedure that:

- (a) Market Participants must follow in the process of applying for Certified Reserve Capacity; and
- (b) the IMO must follow in processing applications for Certified Reserve Capacity, including how Certified Reserve Capacity is assigned and Reserve Capacity Obligation Quantities are set,

in the Reserve Capacity Procedure. The IMO and Market Participants must follow that documented Market Procedure when Market Participants are applying for Certified Reserve Capacity and when the IMO is processing those applications.

4.10. Information Required for the Certification of Reserve Capacity

It is proposed that loss factors be ignored in specifying Capacity Credits. While losses might theoretically be worth considering in the context of a central planning approach, the approach we are implementing is a back up against the market failing to provide adequate capacity and that the inclusion of losses adds a range of complexities that are unlikely to be justified. Issues with trying to implement a loss factor regime are that:

- a) The loss factors will have to be estimated at least two years in advance.
- b) The loss factor used in the energy market may not be the appropriate loss factors as the average marginal losses are not reflective of losses at peak time.
- c) Uncertainties over what capacity will be required and the availability of capacity across the market will dominate any concerns about losses at the edge of the system.

Further, losses are fully accounted for in the Bilateral, STEM and dispatch process so these will still influence locational decisions. It should be noted that losses would be factored into the Reserve Capacity Requirement.

4.10.1. The information to be submitted with an application for certification of Reserve Capacity must pertain to the Reserve Capacity Cycle to which the certification relates and must include:

- (a) the identity of the Facility;
- (b) the Reserve Capacity Cycle to which the application relates;
- (c) if the Facility is yet to enter service:
 - i. with the exception of applications for Conditional Certified Reserve Capacity, a letter from the relevant Network Operator indicating that it has made an Access Offer in respect of the Facility and that the Facility will be entitled to have access from a specified date occurring prior to the date specified in clause 4.10.1(c)(iii)(7);

- ii. with the exception of applications for Conditional Certified Reserve Capacity, evidence that any necessary Environmental Approvals have been granted or evidence supporting the Market Participant's expectation that any necessary Environmental Approvals will be granted in time to have the Facility meet its Reserve Capacity Obligations by the date specified in clause 4.10.1(c)(iii)(7);
- iii. key project dates occurring after the date the request is submitted to the IMO, including, as applicable, but not limited to:
 - 1. when all approvals will be finalised or, in the case of Interruptible Loads and Curtailable Loads all required contracts will be in place;
 - 2. when financing will be finalised;
 - 3. when site preparation will begin;
 - 4. when construction will commence;
 - 5. when generating equipment or Dispatchable Load equipment will be installed or, in the case of Interruptible Loads and Curtailable Loads all required control equipment will be in place;
 - 6. when the Facility will be ready for commissioning trials; and
 - 7. when the Facility will first be capable of meeting Reserve Capacity Obligations in full;
- (d) if the Facility is a Registered Facility that will be decommissioned prior to the date specified in clause 4.1.30(a) for the Reserve Capacity Cycle to which the application relates, the planned decommissioning date;
- (e) for a generation system other than an Intermittent Generator:
 - i. the capacity of the Facility and the temperature dependence of that capacity;

The temperature dependence referred to in the above clause relates to the physical characteristics of a generator etc, the next two clauses relate to the connection point and are not required to be specified as functions of temperature.

- ii. the maximum sent out capacity, net of Intermittent Loads, embedded and parasitic loads, that can be guaranteed to be available for supply to the relevant Network from the Facility when it is operated normally at an ambient temperature of 41°C;
- iii. the maximum sent out capacity, net of Intermittent Loads, embedded and parasitic loads, beyond the capacity described in (ii), that can be made available for supply to the relevant Network from the Facility at

Chapter 4

an ambient temperature of 41°C and any restrictions on the availability of that capacity, including limitations on duration;

The capacity in (ii) might exceed that in (iii) because the facility is running at above rated capacity, and/or because the embedded and parasitic loads have been reduced. This information allows the IMO to limit the amount of additional capacity it schedules to reflect the amount of time it might actually be used.

- iv. at the option of the applicant, the method to be used to measure the ambient temperature at the site of the Facility for the purpose of defining the Reserve Capacity Obligation Quantity, where the method specified may be either:
 1. a publicly available daily maximum temperature at a location representative of the conditions at the site of the Facility as reported daily by a meteorological service; or
 2. a daily maximum temperature measured at the site of the generator by the SCADA system operated by System Management.

(Where no method is specified, a temperature of 41°C will be assumed);

Assuming 41°C will be an attractive approach for generators with capacity that have no significant temperature dependency.

- v. subject to clause 4.10.2, details of primary and any alternative fuels, including details and evidence of both firm and non-firm fuel supplies and the factors that determine restrictions on fuel availability that could prevent the Facility operating at its full capacity;
 - vi. the expected forced and unforced outage rate based on manufacturer data; and
 - vii. for Facilities that have operated for at least 12 months, the forced and unforced outage rate of the Facility;
- (f) for Interruptible Loads, Curtailable Loads and Dispatchable Loads, details for each of up to three blocks of capacity of:
- i. either
 1. the Reserve Capacity expected to be available; or
 2. the Stipulated Default Load;

If the Reserve Capacity is provided by running a generator embedded within the load then the Reserve Capacity procedure allows for a set amount of capacity to be offered where this is related to the capacity of the generator. Alternatively, a Stipulated Default Load can be specified which indicates the consumption level that the provider will remain below if called.

Chapter 4

The Reserve Capacity procedures requires that the IMO assess the Reserve Capacity associated with Stipulated Default Load in terms of the expected load reduction based on historic data.

- ii. the maximum number of hours per year the block is available to provide Reserve Capacity, where this must be not less than 24 hours;
- iii. the maximum number of hours per day that the block is available to provide Reserve Capacity if called, where this must be not less than four hours; and
- iv. the maximum number of times the block can be called to provide Reserve Capacity during a 12 month period;

The 3 blocks of capacity allows (mainly) industrial processes to offer different availabilities of Reserve Capacity from one facility (e.g. 1 MW of load reduction can be made 100 hours per year while an additional 10 MW of reduction can be made for 10 hours per year).

- (g) for all Facilities:
 - i. any restrictions on the availability of the Facility due to staffing constraints; and
 - ii. any other restrictions on the availability of the Facility;
- (h) whether the application relates to confirmation of Conditional Certified Reserve Capacity;
- (i) whether the applicant wishes to nominate the use of the methodology described in clause 4.11.2(b), in place of that described in clause 4.11.1(a), in assigning the Certified Reserve Capacity or Conditional Certified Reserve Capacity to apply to a Scheduled Generator or a Non-Scheduled Generator; and
- (j) whether the Facility will be subject to a Network Control Service contract.

This nomination provides the option for the same basic method as is applied to individual intermittent generators to be used. It is included in the procedure and exists so that all generators can at least ensure the same level of capacity credit coverage as allowed for intermittent generators.

4.10.2. For the purpose of clause 4.10.1(e)(v), an applicant may not claim that a Facility has an alternative fuel unless the Facility has on-site storage, or uninterrupted supply of that fuel, sufficient to maintain 12 hours of operation.

Without the above requirement, the IMO would not be able to have confidence in the Reserve Capacity associated with facilities that rely on an alternative fuel at some times.

4.10.3. An application for certification of Reserve Capacity for an Intermittent Generator that is yet to enter service **must** include a report prepared by an expert accredited by the

IMO, in accordance with the Reserve Capacity Procedure, where this report is to be used to assign the Certified Reserve Capacity for that Facility in accordance with clause 4.11.1(e).

4.11. Setting Certified Reserve Capacity

4.11.1. Subject to clause 4.11.7, the IMO must apply the following principles in assigning a quantity of Certified Reserve Capacity to a Facility for the Reserve Capacity Cycle to which the application relates:

- (a) subject to paragraphs (d) and (e) and clause 4.11.2, the Certified Reserve Capacity for a Facility for a Reserve Capacity Cycle is not to exceed the IMO's reasonable expectation as to the amount of capacity likely to be available from that Facility, after netting off capacity required to serve Intermittent Loads, embedded loads and parasitic loads, at daily peak demand times in the period from the start of December in Year 3 of the Reserve Capacity Cycle to the end of July in Year 4 of the Reserve Capacity Cycle, assuming an ambient temperature of 41°C;
- (b) where the Facility is a generation system (other than an Intermittent Generator), the Certified Reserve Capacity must not exceed the sum of the capacities specified in clauses 4.10.1(e)(ii) and 4.10.1(e)(iii);
- (c) the IMO must not assign Certified Reserve Capacity to a Facility for a Reserve Capacity Cycle if:
 - i. that Facility is not operational or is not scheduled to commence operation for the first time so as to meet its Reserve Capacity Obligations by 30 November of Year 3 of that Reserve Capacity Cycle; or
 - ii. that Facility will cease operation permanently, and hence cease to meet Reserve Capacity Obligations, from a time earlier than 1 August of Year 4 of that Reserve Capacity Cycle;
- (d) the IMO must assign Certified Reserve Capacity for Intermittent Generators that are already operating equal to the Relevant Level determined in accordance with clause 4.11.3A but subject to (b), (c), (f), (g), (h) and (i).
- (e) the IMO must assign Certified Reserve Capacity to an Intermittent Generator that is yet to commence operation based on :
 - i. the Certified Reserve Capacity estimate contained in any report provided by the applicant in accordance with clause 4.10.3, where:
 - 1. the report was produced by an expert accredited by the IMO in accordance with clause 4.11.6; and
 - 2. the estimate reflects what the expert considers the Certified Reserve Capacity of the Facility would have been for the

purposes of clause 4.11.2(b) had a history of performance been available.

- (f) the IMO must not assign Certified Reserve Capacity to a Facility that is not expected to be Registered Facility by the time its Reserve Capacity Obligations for the Reserve Capacity Cycle would take effect;
- (g) in respect of a Facility that will be subject to a Network Control Service contract, the IMO must not assign Certified Reserve Capacity in excess of the capacity that the IMO believes that Facility can usefully contribute given its location and any transmission constraints that are likely to occur;
- (h) the IMO may decide not to assign Certified Reserve Capacity to a Facility if:
 - i. the Facility has operated for at least 36 months and has had a Forced Outage rate of greater than 15% or a combined Planned Outage rate and Forced Outage rate of greater than 30% over the preceding 36 months; or
 - ii. the Facility has operated for less than 36 months, or is yet to commence operation, and the IMO has cause to believe that over a period of 36 months the Facility is likely to have a Forced Outage rate of greater than 15% or a combined Planned Outage rate and Forced Outage rate of greater than 30%,

where the Planned Outage rate and the Forced Outage rate for a Facility for a period will be calculated in accordance with the Power System Operation Procedure. (The IMO may consult with System Management in deciding whether or not to refuse to grant Certified Reserve Capacity under this paragraph); and

The percentages specified here are unlikely to be an issue for existing generators in the SWIS and are intended to discourage the installation of unreliable facilities purely so as to gain access to Reserve Capacity payments.

- (i) the Certified Reserve Capacity assigned to a Facility is to be expressed to a precision of 0.005 MW.

4.11.2. Where an applicant nominates under clause 4.10.1(i) to have the IMO use the methodology described in clause 4.11.2(b) to apply to a Scheduled Generator or a Non-Scheduled Generator, the IMO:

- (a) may reject the nomination if the IMO reasonably believes that the capacity of the Facility has permanently declined, or is anticipated to permanently decline prior to or during the Reserve Capacity Cycle to which the Certified Reserve Capacity relates. If the IMO rejects such a nomination it must process the application as it would if no nomination to use the method described in clause 4.11.2(b) had been made;

Chapter 4

- (b) if it has not rejected the nomination under paragraph (a), must assign a quantity of Certified Reserve Capacity to the relevant Facility for the Reserve Capacity Cycle equal to the Relevant Level determined in accordance with clause 4.11.3A, but subject to clauses 4.11.1(b), 4.11.1(c), 4.11.1(f), 4.11.1(g), 4.11.1(h) and 4.11.1(i).

4.11.3. [Blank]

4.11.3A. The Relevant Level in respect of a Facility at a point in time is determined by the IMO following these steps:

- (a) take all the Trading Intervals that fell within the last three years up to, and including, the last Hot Season;
- (b) determine the amount of electricity (in MWh) sent out by the Facility in accordance with metered data submissions received by the IMO in accordance with clause 8.4 during these Trading Intervals;
- (c) If the Generator has not entered service, or if it entered service during the period referred to in step (a), estimate the amount of electricity (in MWh) that would have been sent out by the facility, had it been in service, for all Trading Intervals occurring during the period referred to in (a) which are prior to it entering service;
- (d) set the Relevant Level as double the sum of the quantities determined in (b) and (c) divided by 52,560.

The Certified Reserve Capacity is calculated as the average output (in MW) during each trading interval over the past three complete years. The result in (d) is doubled to convert an average MWh quantity over a half hour Trading Interval to the equivalent MW value. In the event that the Facility has not been in service for three years, the average is calculated based on the actual output for the period when the Facility was in operation and the estimated output for the period before it entered service.

4.11.4. When assigning Certified Reserve Capacity to a block of capacity provided by Interruptible Load, Curtailable Load, or Dispatchable Load, the IMO must indicate what Availability Class is applicable to that Reserve Capacity where this Availability Class must reflect the maximum number of hours per year that the capacity will be available.

4.11.5. In assigning Certified Reserve Capacity to a Facility, the IMO may seek information from Network Operators to confirm the accuracy of data provided to it, but, other than the name of the Facility, must not provide information to Network Operators that was provided to it as part of an application for Certified Reserve Capacity except with the permission of the applicant.

Chapter 4

4.11.6. The IMO must accredit not less than two independent experts at any time to prepare reports on the estimated Reserve Capacity of Intermittent Generators that are yet to commence operation, at the expense of the applicant. The IMO:

- (a) must publish the contact details of these accredited independent experts on the Market Web Site;
- (b) must ensure that any expert it accredits is familiar with the meaning of the value to be estimated; and
- (c) can remove accreditation of an expert at any time, but must allow the expert to complete any work in progress as an accredited expert at the time accreditation is removed.

4.11.7. Subject to clause 4.11.9 for the first Reserve Capacity Cycle, the Certified Reserve Capacity assigned to all Western Power generation systems is 3,224 MW. This amount is not to be allocated to individual generation systems, but is instead to be associated with Western Power's portfolio of Scheduled Generators and Unscheduled Generators.

4.11.8. Western Power must notify the IMO of the quantity of Certified Reserve Capacity it considers it has available for the period from the Trading Day commencing on 1 November 2007 and until the Trading Day ending on 1 August 2008 ("**relevant period**") by the date and time specified in clause 4.1.11, including supporting evidence, where that quantity:

- (a) must only include capacity provided by Facilities that are committed to be available during the relevant period; and
- (b) must include any capacity that Western Power has procured under contracts with third parties that give Western Power the right to dispatch the capacity during the relevant period.

4.11.9. The IMO must review the information provided by Western Power in accordance with clause 4.11.8 and if the IMO, taking into account the information provided by Western Power under clause 4.11.8, considers that the capacity available to Western Power during the relevant period will be different to the Certified Reserve Capacity assigned to Western Power's generation systems under clause 4.11.7, then the IMO may review that value.

4.12. Setting Reserve Capacity Obligations

A number of clauses in this section refer to MWh quantities over a Trading Interval being doubled to produce an equivalent MW quantity. These conversions are required because if the obligation is to supply 100 MW in a Trading Interval of 30 minutes duration, then this corresponds to supplying a maximum of 50 MWh if 100 MW is offered for the Trading Interval.

Chapter 4

4.12.1. The Reserve Capacity Obligations of a Market Participant holding Capacity Credits, are as follows:

- (a) a Market Participant (other than the Electricity Generation Corporation) must ensure that for each Trading Interval:
- i. the aggregate MW equivalent of the quantity of Capacity Credits held by the Market Participant applicable in that Trading Interval for Interruptible Loads and Curtailable Loads registered by the Market Participant; plus
 - ii. the MW quantity calculated by doubling the total MWh quantity of energy to be sent out during the Trading Interval by Facilities registered by that Market Participant, as indicated in the applicable Resources Plans; plus
 - iii. the MW quantity calculated by doubling the total MWh quantity covered by STEM Offers which were not scheduled and the STEM Bids which were scheduled in the relevant STEM Auction determined by the IMO for that Market Participant under clause 6.9 for that Trading Interval, corrected for loss factor adjustments so as to be a sent out quantity,

is not less than the total Reserve Capacity Obligation Quantity for that Trading Interval for Facilities registered by the Market Participants, less double the total MWh quantity to be provided as Ancillary Services as specified by the IMO for that Market Participant in accordance with clause 6.3A.2(e)(i).

Interruptible Loads and Curtailable Loads are treated as a special case. We cannot require these to be included in STEM Offers because that could result in them being activated more times than they are actually available. Instead, we assume that Market Participants will account for them in their STEM bids (for consumption) like they would any other load, and preclude them from appearing in Resource Plans as a way of meeting the load already scheduled (i.e they are treated just like Non-Dispatchable Load). The obligation on an Interruptible Load or Curtailable Load is defined in terms of dropping consumption below a defined level (the Stipulated Default Load), or producing some amount of energy with an embedded generator, and consequently if Market Participant reduces its consumption to this Stipulated Default Load or runs the embedded generator as a result of STEM prices, or other factors, it will still have satisfied its obligations if called for that Trading Interval. However, the fact that these resources are not required to be accounted for in the STEM does not mean they cannot be called in real-time.

This amounts to ensuring that adequate capacity is offered into the STEM and available in real-time. However, since the Bilateral Position is a net position for Market Participants other than the Electricity Generation Corporation, reflecting supply less demand, we cannot refer to the bilateral position plus the STEM offer. Consider a 1000 MW generator with 1000 MW

Chapter 4

of own load – its net bilateral position could be zero and its STEM offer could be zero, but it is still meeting its obligations if the 1000 MW of generation is in its Resource Plan.

- (b) the Electricity Generation Corporation must ensure that for each Trading Interval:
- i. [Blank]
 - ii. the MW quantity calculated by doubling the total MWh quantity which the Electricity Generation Corporation is selling to other Market Participants as indicated by the applicable Net Contract Position of the Electricity Generation Corporation, corrected for loss factor adjustments so as to be a sent out quantity; plus
 - iii. the MW quantity calculated by doubling the total MWh quantity covered by STEM Offers which were not scheduled and the STEM Bids which were scheduled in the relevant STEM Auction determined by the IMO for the Electricity Generation Corporation under clause 6.9 for that Trading Interval, corrected for loss factor adjustments so as to be a sent out quantity,
- is not less than the total Reserve Capacity Obligation Quantity for the Electricity Generation Corporation for that Trading Interval, less double the total MWh quantity to be provided as Ancillary Services as specified by the IMO for the Electricity Generation Corporation in accordance with clause 6.3A.2(e)(i).
- (c) the Market Participant must make the capacity associated with the Capacity Credits provided by a Facility applicable to a Trading Interval, up to the Reserve Capacity Obligation Quantity for the Facility for that Trading Interval, available for dispatch by System Management in accordance with Chapter 7.

4.12.2. A Market Participant holding Capacity Credits must also comply with the following obligations:

- (a) the Market Participant must comply with outage planning obligations specified in clauses 3.18, 3.19, 3.20 and 3.21;
- (b) the Market Participant must submit to tests of availability of capacity and inspections conducted in accordance with clause 4.25;
- (c) the Market Participant must comply with Reserve Capacity performance monitoring obligations in accordance with clause 4.27; and
- (d) the Market Participant must, in relation to each Facility assigned Certified Reserve Capacity on the basis of having an alternative fuel available, maintain adequate fuel for 12 hours of operation except on any Trading Day for which the IMO has waived this requirement in response to a Planned Outage or in the event of an extended Forced Outage.

Chapter 4

4.12.3. The IMO must use the information described in clauses 4.10.1 and 4.25.12 to set the Reserve Capacity Obligation Quantity to apply to a Facility in each Trading Interval. The Reserve Capacity Obligation Quantity to apply to a Facility may differ between Trading Intervals.

4.12.4. Subject to clause 4.12.5, the IMO must apply the following principles in establishing the initial Reserve Capacity Obligation Quantity to apply for a Facility for a Trading Interval:

- (a) the Reserve Capacity Obligation Quantity is not to exceed the Certified Reserve Capacity held by the Market Participant for the Facility;
- (aA) for generation systems that are Intermittent Generators, the Reserve Capacity Obligation Quantity is zero;
- (b) for generation systems other than Intermittent Generators, except where otherwise precluded by this clause 4.12.4, the Reserve Capacity Obligation Quantity:
 - i. must not be less than the amount specified in clause 4.10.1(e)(ii) except on Trading Days when the maximum daily temperature at the site of the generator exceeds 41°C, in which case the Reserve Capacity Obligation Quantity must not be less than the amount specified in clause 4.10.1(e)(ii) adjusted to an ambient temperature of 45°C;
 - ii. may exceed the amount in clause 4.12.4(b)(i) by an amount up to the amount specified in clause 4.10.1(e)(iii), adjusted to an ambient temperature of 45°C on Trading Days when the maximum daily temperature at the site of the generator exceeds 41°C, for not more than the maximum duration specified in accordance with clause 4.10.1(e)(iii); and
 - iii. must account for staffing and other restrictions on the ability of the Facility to provide energy upon request; and
- (c) for Interruptible Loads, Curtailable Loads and Dispatchable Loads, except where otherwise precluded by this clause 4.12.4, the Reserve Capacity Obligation Quantity for each block:
 - i. must be required to be available for a number of hours per year that does not exceed the maximum number of hours per year as specified in accordance with clause 4.10.1(f)(ii);
 - ii. must be required to be available for a number of hours per day that does not exceed the maximum number of hours per day as specified in accordance with clause 4.10.1(f)(iii);
 - iii. must be specified as dropping to zero once the capacity from the block has been called the maximum number of times per year as specified in accordance with clause 4.10.1(f)(iv); and

- iv. must account for staffing and other restrictions on the ability of the Facility to provide energy upon request.

4.12.5. For the first Reserve Capacity Cycle, the initial Reserve Capacity Obligation Quantity for Western Power's generation systems is to equal the Certified Reserve Capacity for Western Power's generation systems, modified such that if the maximum ambient temperature at the site of Western Power's generation systems exceeds 41°C on a Trading Day, as measured by Western Power's SCADA system, then Western Power's Reserve Capacity Obligation Quantity for that Trading Day is to be reduced by the difference between that generation system's rated capacity at 41°C and its rated capacity at 45°C.

4.12.6. Subject to clause 4.12.7, any initial Reserve Capacity Obligation Quantity set in accordance with clauses 4.12.4, 4.12.5, or 4.28B.4 is to be reduced once the Reserve Capacity Obligations take effect, as follows:

- (a) if the aggregate MW equivalent to the quantity of Capacity Credits (as modified from time to time under the Market Rules) for a Facility is less than the Certified Reserve Capacity for that Facility at any time (for example as a result of the application of clause 4.20.1, clause 4.25.4 or clause 4.25.6), then the IMO must reduce the Reserve Capacity Obligation Quantity to reflect the amount by which the aggregate Capacity Credits fall short of the Certified Reserve Capacity;
- (b) subject to clause 4.27.9, during Trading Intervals where there is a Planned Outage for a Facility approved by System Management or a Consequential Outage, the IMO must reduce the Reserve Capacity Obligation Quantity for that Facility, after taking into account any adjustments in accordance with paragraph (a), to reflect the amount of capacity unavailable due to that outage; and
- (c) if the Facility is subject to a Commissioning Test during a Trading Interval then the Reserve Capacity Obligation Quantity for that Facility must be zero during that Trading Interval.

4.12.7. If a Facility assigned Certified Reserve Capacity is not a Registered Facility for any time period during which its Reserve Capacity Obligations apply, then the Market Participant which holds the Capacity Credits provided by that Facility will be deemed to have failed to satisfy its Reserve Capacity Obligations during that time period.

Commitment of Capacity to Auction or Bilateral Trade

4.13. Reserve Capacity Security

4.13.1. Where the IMO assigns Certified Reserve Capacity to a Facility yet to be commissioned, the relevant Market Participant must ensure that the IMO holds the benefit of a Reserve Capacity Security in an amount not less than the amount

Chapter 4

determined under clause 4.13.2 by the date and time specified in clause 4.1.13 for the Reserve Capacity Cycle to which the Certified Reserve Capacity relates.

4.13.2. The amount for the purposes of clause 4.13.1 is twenty-five percent of the Maximum Reserve Capacity Price included in the most recently issued Request for Expressions of Interest at the time the Certified Reserve Capacity is assigned, expressed in \$/MW per year, multiplied by an amount equal to:

- (a) the Certified Reserve Capacity assigned to the Facility; less
- (b) the total of any Certified Reserve Capacity amount specified in accordance with clause 4.14.1(d) or referred to in clause 4.14.7(c)(ii).

So a security deposit must be paid on the entire capacity certified, unless that capacity will not be made available to the market either via the auction or bilateral trade. Note that if someone applies for Certified Reserve Capacity relating to a future Reserve Capacity Cycle then they will have a security deposit specified based on the Maximum Reserve Capacity Price at the time they apply, though will not have to pay this Security Deposit until the normal time in the Reserve Capacity Cycle to which the certification relates.

The 25% rule corresponds to about 90 days of payment at the Maximum Reserve Capacity Price. The security deposit is not intended to recover the cost of damages if the capacity does not eventuate, as this could require a significantly higher security deposit which could discourage participation. However, it is necessary to have some security deposit as otherwise persons could participate in this process with no intent of supplying the capacity without consequence (since the financial ramifications of not meeting Reserve Capacity obligations are capped at the value of the payments for meeting those Reserve Capacity obligations. See clause 4.26).

If the clauses referred to in clause 4.13.3 are not activated at the same time as Chapter 4 these clause may need to be repeated here given that all or part of Chapter 4 is likely to commence before the remainder of the Market Rules.

4.13.3. Where a Market Participant's existing Reserve Capacity Security is due to expire or terminate, then that Market Participant must, at least 10 Business Days before the time when the existing Reserve Capacity Security will expire or terminate, ensure that the IMO holds the benefit of a replacement Reserve Capacity Security in an amount not less than the level required under clause 4.13.2 that will become effective at the expiry of the existing Reserve Capacity Security.

4.13.4. Where a Market Participant's Reserve Capacity Security is no longer current or valid (for example, because the Reserve Capacity Security provider ceases to meet the Acceptable Credit Criteria), then that Market Participant must ensure that the IMO holds the benefit of a replacement Reserve Capacity Security in an amount not less than the level required under clause 4.13.2 within one Business Day.

4.13.5. The Reserve Capacity Security for a Market Participant must be:

Chapter 4

- (a) an obligation in writing that:
 - i. is from a Reserve Capacity Security provider, who must be an entity which meets the Acceptable Credit Criteria and which itself is not a Market Participant;
 - ii. is a guarantee or bank undertaking in a form prescribed by the IMO;
 - iii. is duly executed by the Reserve Capacity Security provider and delivered unconditionally to the IMO;
 - iv. constitutes valid and binding unsubordinated obligations to the Reserve Capacity Security provider to pay to the IMO amounts in accordance with its terms which relate to the obligations of the relevant Market Participant under the Market Rules to pay compensation under clause 4.13.11; and
 - v. permits drawings or claims by the IMO to a stated amount; or
- (b) if the IMO in its discretion considers it an acceptable alternative in the circumstances to the obligation under clause 4.13.5(a), a cash deposit ("**Security Deposit**") made with the IMO (on terms acceptable to the IMO in its discretion) by or on behalf of the Market Participant.

4.13.6. Where Reserve Capacity Security is provided as a Security Deposit in accordance with clause 4.13.5(b), it will accrue interest daily at the IMO Deposit Rate, and the IMO must pay the Market Participant the interest accumulated at the end of each calendar month less any liabilities and expenses incurred by the IMO, including bank fees and charges.

4.13.7. An entity meets the Acceptable Credit Criteria if it is:

- (a) either:
 - i. a bank under the prudential supervision of the Australian Prudential Regulation Authority; or
 - ii. a central borrowing authority of an Australian State or Territory which has been established by an Act of Parliament of that State or Territory;
- (b) resident in, or has a permanent establishment in, Australia;
- (c) not an externally-administered body corporate (within the meaning of the Corporations Act), or under a similar form of administration under any laws applicable to it in any jurisdiction;
- (d) not immune from suit;
- (e) capable of being sued in its own name in a court of Australia; and
- (f) has an acceptable credit rating, being either:

Chapter 4

- i. a rating of A-1 or higher for short term unsecured counterparty obligations of the entity, as rated by Standard and Poor's (Australia) Pty. Limited; or
- ii. a rating of P-1 or higher for short term unsecured counterparty obligations of the entity, as rated by Moodys Investor Services Pty. Limited.

4.13.8. The IMO must develop a Market Procedure dealing with:

- (a) determining Reserve Capacity Security;
 - (b) assessing persons against the Acceptable Credit Criteria;
 - (c) Reserve Capacity Security arrangements, including:
 - i. the form of acceptable guarantees and bank undertakings;
 - ii. where and how it will hold cash deposits and how the costs and fees of holding cash deposits will be met;
 - iii. the application of monies drawn from Reserve Capacity Security in respect of amounts payable by the relevant Market Participant to the IMO under clause 4.13.11;
 - (d) other matters relating to clauses 4.13.3 to 4.13.7,
- and Market Participants and the IMO must comply with that Market Procedure.

4.13.9. If a Market Participant does not comply with clause 4.13.1 in full by the date and time specified in:

- (a) clause 4.1.13(a) in the case of Facility with Certified Reserve Capacity specified to be traded bilaterally in accordance with clause 4.14.1(c); or
- (b) clause 4.1.13(b) in the case of Facility with Certified Reserve Capacity specified to be offered into the Reserve Capacity Auction in accordance with clause 4.14.1(a) and where none of the Facility's Certified Reserve Capacity is specified to be traded bilaterally in accordance with clause 4.14.1(c),

for the Reserve Capacity Cycle to which the certification relates, the Certified Reserve Capacity of that Facility will lapse.

Clauses 4.13.1 and 4.13.2 mean that if capacity is certified in 2004 for an auction to be held in 2009 then the security deposit will be based on the 2004 Maximum Reserve Capacity Price but the deposit is not required to be paid until 2009. This gives certainty to those seeking certification.

4.13.10. Unless clause 4.13.11 applies, the IMO must notify any Market Participant that has provided the IMO with a Reserve Capacity Security for a Facility that the need to maintain that Reserve Capacity Security has ceased, and must refund any

Chapter 4

Reserve Capacity Security which is in the form of a cash deposit (plus interest earned on that cash deposit) no later than five Business Days following:

- (a) the time and date specified in clause 4.1.21, in the case of a Reserve Capacity Security relating to a Facility that provides no Capacity Credits (as notified by the relevant Market Participant under clause 4.20);
- (b) in respect of a new Facility that satisfies 100% of its Reserve Capacity Obligation Quantity for the Facility in at least one Trading Interval when the Reserve Capacity Obligation Quantity exceeds 0 MW occurring between the date from which Reserve Capacity Obligations apply in accordance with clause 4.1.26 and the day from which Reserve Capacity Obligations cease to apply in accordance with clause 4.1.30 in respect of the Reserve Capacity Cycle, the later of:
 - i. the date from which Reserve Capacity Obligations apply in accordance with clause 4.1.26 in respect of the Reserve Capacity Cycle;
 - ii. the first day on which a new Facility first satisfies its Reserve Capacity Obligations under clause 4.12.1(a) or (b) (as applicable) in respect of the Reserve Capacity Cycle.
- (c) in respect of a new Facility to which none of (a), (b), or clause 4.13.11 relate, the day from which Reserve Capacity Obligations cease to apply in accordance with clause 4.1.30 in respect of the Reserve Capacity Cycle.

Clause (c) means that if a Facility covers at least 90% of its Reserve Capacity Obligation Quantity but never covers 100% of it, then it will only get its security deposit back after having completed its obligations to supply capacity.

- 4.13.11. If a Market Participant provides a Reserve Capacity Security in respect of a Facility under this clause 4.13, and the relevant Facility does not operate at a level (expressed in MWh) that is at least 90% of one-half of the Reserve Capacity Obligation Quantity for the Facility (expressed in MW), in at least one Trading Interval when the Reserve Capacity Obligation Quantity exceeds 0 MW occurring between the date from which Reserve Capacity Obligations apply in accordance with clause 4.1.26 and the day from which Reserve Capacity Obligations cease to apply in accordance with clause 4.1.30 in respect of the Reserve Capacity Cycle, then the Market Participant must pay to the IMO, as compensation to the market, an amount equal to the Reserve Capacity Security amount, which obligation may be satisfied by the IMO drawing upon the Reserve Capacity Security, and applying the amount claimed (after meeting the IMO's costs associated with doing so) so as to:
- (a) firstly, offset the cost of funding Supplementary Capacity Contracts for any capacity shortage stemming entirely or in part from the Facility not being available; and

Chapter 4

- (b) secondly, once all costs to which paragraph (a) refers are covered, make a rebate payment to Market Customers in proportion to their Individual Reserve Capacity Requirements during the Trading Month in accordance with Chapter 9.

For example, if the Reserve Capacity Obligation Quantity is 120MW then the target for clause 4.13.11 will be 90% of 60MWh, i.e. 54 MWh in at least one Trading Interval during the period to which the Reserve Capacity Obligations pertain.

The logic for this allocation is that if a shortage results from the capacity not being available, then the security deposit should be used first to fund that. Any loads holding Capacity Credits from the facility get the benefit of that facility, even though the facility does not meet its obligations, hence there is no obvious reason to pay the security deposit back to those loads. Hence, any left over funds will be allocated across all loads evenly.

- 4.13.12. If the Reserve Capacity Security drawn upon under clause 4.13.11 is a cash deposit, then the Market Participant forfeits the amount of the cash deposit.

4.14. Market Participant Auction and Bilateral Trade Declaration

- 4.14.1. Subject to clause 4.14.3, each Market Participant holding Certified Reserve Capacity for the current Reserve Capacity Cycle must, by the date and time specified in clause 4.1.14 provide the following information to the IMO for each Facility or, in the case of Interruptible Loads, Curtailable Loads and Dispatchable Loads with at least two blocks holding Certified Reserve Capacity in different Availability Classes, for each block in respect of which it holds Certified Reserve Capacity (expressed in MW to a precision of 0.005 MW):

- (a) the total amount of Reserve Capacity the Market Participant intends to make available in a Reserve Capacity Auction if held for the current Reserve Capacity Cycle, where the amount to be made available is not to include Reserve Capacity covered by a pre-existing Special Price Arrangement;

Capacity covered by Special Price Arrangement's cannot be offered into an auction.

- (b) the total amount of Reserve Capacity covered by a pre-existing Special Price Arrangement that the Market Participant intends will not be traded bilaterally;

Capacity covered by Special Price Arrangements that is not traded bilaterally will automatically be scheduled in the auction, without any offer being required.

- (c) the total amount of Reserve Capacity the Market Participant intends will be traded bilaterally;

This is a simple declaration and there is no obligation to provide any supporting evidence. During the year to which the Capacity Credit obligations relate, the Market Participant is supposed to submit to the IMO each month how many Capacity Credits it is trading

Chapter 4

bilaterally with each other party (including its own load) so that the IMO can adjust settlement statements accordingly (see clause 9.4). All that happens if no information is submitted is that holder of the Capacity Credits will be settled at the auction price. In other words, indicating bilateral trade is equivalent to becoming a price taker in the auction (since bilateral trades are removed from the auction requirement) with the right to be paid the auction price if the Market Participant fails to notify the IMO of any bilateral trade during a given Trading Month during the period when the obligations are in force.

- (d) the total amount of Reserve Capacity that the Market Participant has decided will not now be made available to the market, where this amount cannot include Reserve Capacity covered by a pre-existing Special Price Arrangement,

Reserve Capacity not made available will cease to be Certified Reserve Capacity. This provides an option for participants to certify capacity prior to finalising whether or not they will actually go ahead with the development of a facility.

where the sum of the values for (a), (b), (c) and (d) must equal the Certified Reserve Capacity of the Facility for the Reserve Capacity Cycle.

4.14.2. A Capacity Credit (and the Reserve Capacity associated with a Capacity Credit) is “traded bilaterally” for the purposes of these Market Rules where:

- (a) the Market Participant holding the Capacity Credits has entered into an arrangement with another Market Participant under which the Capacity Credits will be allocated to the other Market Participant for settlement purposes to allow the other Market Participant to meet its Individual Reserve Capacity Requirement in accordance with clauses 9.4 and 9.5; or
- (b) the Market Participant holding the Capacity Credit allocates the Capacity Credit for settlement purposes to meet its own Individual Reserve Capacity Requirement in accordance with clauses 9.4 and 9.5.

4.14.3. A Market Participant may not make a submission under clause 4.14.1 with respect to a Facility subject to a Network Control Service Contract.

These Facilities will be automatically assigned Capacity Credits.

4.14.4. The value specified by **the Electricity Generation Corporation** in accordance with clause 4.14.1(c) must be not less than:

- (a) the lesser of:
 - i. the total Certified Reserve Capacity held **by the Electricity Generation Corporation**; and
 - ii. **the Electricity Generation Corporation's** peak load, as determined in accordance with clause 4.14.5 multiplied by an amount equal to:
 - 1. the Reserve Capacity Requirement; divided by

Chapter 4

2. the expected peak demand corresponding to the Reserve Capacity Requirement, as determined in accordance with clause 4.6.2; less
- (b) the Minimum Frequency Keeping Capacity.

The purpose of this clause is to limit the Electricity Generation Corporation's participation in the Reserve Capacity auction to capacity not required to cover its current own peak bilateral energy trades. Note that if the Electricity Generation Corporation's peak bilateral energy trade is actually lower in the year in question, then the Electricity Generation Corporation can still be paid the Reserve Capacity Auction price on its surplus capacity, it just will not have been able to offer that capacity into the auction.

While data in Bilateral Submissions is Loss Factor adjusted while Capacity Credits are not, this discrepancy is not considered significant in this context.

- 4.14.5. For the purpose of clause 4.14.4, the Electricity Generation Corporation's peak load is calculated by doubling the average of the Electricity Generation Corporation's supply quantities (expressed in MWh) specified in the Bilateral Submissions that applied during the 12 peak Trading Intervals, as specified in Appendix 5, of the previous Hot Season. Prior to the completion of the first Hot Season following Energy Market Commencement:
- (a) this value will be determined by the IMO and provided to the Electricity Generation Corporation not less than 20 Business Days prior to the date specified in clause 4.1.14.
 - (b) [Blank]
- 4.14.6. If two or more Facilities cannot simultaneously exist (for example, because more than one Market Participant is proposing to build a Facility that will be located at the same site,) then the IMO cannot accept a non-zero value provided in accordance with clause 4.14.1(c) in respect of more than one of these Facilities and must reject all but one Facility based on the following criteria:
- (a) Facilities that are operational or are under construction will be accepted ahead of other Facilities; then
 - (b) if more than one Facility remains, then Facilities that can demonstrate having secured financing will be accepted ahead of other Facilities; then
 - (c) if more than one Facility remains, then Facilities with the greatest quantity of Certified Reserve Capacity will be accepted ahead of Facilities with lower Certified Reserve Capacity; then
 - (d) if more than one Facility remains, then Facilities identified in Expressions of Interest will be accepted ahead of other Facilities; then

Chapter 4

- (e) if more than one Facility remains, then the IMO will accept one based on the order in which they applied for Certified Reserve Capacity, including applications for Conditional Certified Reserve Capacity.

These rules are designed to resolve which facility will be included in the test for acceptance of bilateral trade only, it is not the process for actually accepting bilateral trade (which is described in clause 4.14.9). If a facility is rejected under this clause, it can still participate in the auction (though can only be accepted in the auction if none of the mutually exclusive facilities are accepted for bilateral trade).

4.14.7. The IMO must review the information provided by Market Participants in accordance with clause 4.14.1 to ensure that the information provided is consistent with the Certified Reserve Capacity of each Facility and the requirements of this clause 4.14, and:

- (a) if the information is not consistent, then the IMO must endeavour to resolve the discrepancy with the Market Participant within one Business Day of receipt;
- (b) if the information is consistent, then the IMO must inform the Market Participant within one Business Day of receipt that the information is accepted; and
- (c) if the IMO cannot establish what a Market Participant's intentions are with respect to all or part of its Certified Reserve Capacity within the time allowed for resolving discrepancies by paragraph (a), then that Market Participant's:
 - i. Certified Reserve Capacity corresponding to pre-existing Long Term Special Price Arrangements cannot be traded bilaterally; and
 - ii. Certified Reserve Capacity not covered by pre-existing Long Term Special Price Arrangements will be treated as being unavailable to the market,

and the IMO must notify the Market Participant of this outcome within one Business Day of the deadline for resolving discrepancies specified in paragraph (a).

4.14.8. If Certified Reserve Capacity is not to be made available to the market as a result of the acceptance by the IMO of information submitted by a Market Participant in accordance with clause 4.14.1(d), or because clause 4.14.7(c)(ii) applies, then all obligations associated with that part of the Certified Reserve Capacity held by the relevant Market Participant are to terminate from the time the IMO notifies the Market Participant that it accepts the information provided in accordance with clause 4.14.1 or the application of clause 4.14.7(c)(ii) (as applicable) and that part of the Certified Reserve Capacity ceases to be Certified Reserve Capacity for the purposes of these Market Rules (including for the purposes of setting the Reserve Capacity Obligation Quantity).

Chapter 4

4.14.9. The IMO must notify each Market Participant that specified a non-zero amount under clause 4.14.1(c) by the date and time specified in clause 4.1.15 of the quantity of Certified Reserve Capacity held by the Market Participant in respect of each Facility that it can trade bilaterally, where this quantity must:

- (a) exclude Certified Reserve Capacity to which clauses 4.14.7(c)(i) and 4.14.8 relate; and
- (b) be determined using the methodology described in Appendix 3.

4.14.10. A Market Participant must make available in any Reserve Capacity Auction held in accordance with clause 4.15 any Certified Reserve Capacity it holds for a Facility, except to the extent that:

- (a) clause 4.14.8 applies;
- (b) the Certified Reserve Capacity is covered by a pre-existing Long Term Special Price Arrangement; or
- (c) IMO has notified the Market Participant in accordance with clause 4.14.9 that the Certified Reserve Capacity can be traded bilaterally.

Reserve Capacity Auctions

4.15. Confirmation or Cancellation of Reserve Capacity Auctions

4.15.1. If the information provided under clause 4.14 indicates that no Certified Reserve Capacity is to be made available in the Reserve Capacity Auction for a Reserve Capacity Cycle, or, based on the information received under clause 4.14, the IMO considers that the Reserve Capacity Requirement for the Reserve Capacity Cycle will be met without an auction, then, by the date and time specified in clause 4.1.16, the IMO must publish a notice specifying for that Reserve Capacity Cycle:

- (a) that the Reserve Capacity Auction has been cancelled;
- (b) the Reserve Capacity Requirement;
- (c) the total amount of Certified Reserve Capacity;
- (d) the total amount of Certified Reserve Capacity that would have been made available in the Reserve Capacity Auction had one been held; and
- (e) the total amount of Certified Reserve Capacity covered by pre-existing Special Price Arrangements;

The purpose of this clause is simply to provide transparency.

4.15.2. If the Reserve Capacity Auction for a Reserve Capacity Cycle is not cancelled in accordance with clause 4.15.1, then, by the date and time specified in clause 4.1.16, the IMO must publish a notice specifying:

- (a) that the Reserve Capacity Auction will be held;

- (b) the Reserve Capacity Auction Requirement, where this equals the Reserve Capacity Requirement less the total amount of Certified Reserve Capacity which:
 - i. the IMO has notified Market Participants can be traded bilaterally under clause 4.14.9; or
 - ii. is covered by a pre-existing Special Price Arrangement; and
- (c) the amount of Reserve Capacity required to be procured via the auction from each Availability Class.

4.16. The Maximum Reserve Capacity Price

The Maximum Reserve Capacity Price is designed to mitigate the potential for abuse of market power. A competitive Reserve Capacity Market should see the price being equivalent to the fixed costs of an open cycle gas turbine, so this price forms the basis for setting the Maximum Reserve Capacity Price. The annualised cost of a 160 MW open cycle peaking plant with firm fuel supply is assumed, though this is estimated based on data for plant with sizes between 155 MW and 165 MW. 160 MW was chosen because it was the size of plant selected for the PPP1 tender and because data suggest the impact of economies of scale on capital costs diminish at this capacity.

The actual value of the Maximum Reserve Capacity Price, like other price limits, is not included explicitly in these rules, but these rules do require that the value be determined in accordance with the methodology specified below and that the price cap is published (see clause 10.5). The Maximum Reserve Capacity Price must be approved by the Economic Regulation Authority.

4.16.1. For all Reserve Capacity Cycles, the IMO must publish a Maximum Reserve Capacity Price as determined in accordance with this clause 4.16 prior to the time specified in clause 4.1.4.

The Maximum Reserve Capacity Price will be included in the Request for Expression of Interest so the previous two clauses require that it be determined prior to the time of the release of the Request for Expression of Interest.

4.16.2. The Maximum Reserve Capacity Price to apply for the first Reserve Capacity Cycle is \$150,000 per MW per year.

4.16.3. The IMO must annually review the value of the Maximum Reserve Capacity Price in accordance with this clause 4.16 and in accordance with the timing requirements specified in clause 4.1.19.

4.16.4. In conducting the review required by clause 4.16.3, the IMO must assess the appropriateness of the following values specified in Appendix 4 for calculating the Maximum Reserve Capacity Price:

Chapter 4

- (a) the optimum size of an open cycle gas turbine for the SWIS, where the optimum size is a size that is expected by the IMO to minimise the cost of energy to Market Customers over the long term;
- (b) the capital cost of open cycle gas turbine power stations based on current data and the methodology specified in Appendix 4;
- (c) the level of electricity transmission connection costs, including:
 - i. the cost of electricity transmission assets required to connect an open cycle gas turbine power station to the SWIS; and
 - ii. an estimate of the cost of augmenting the shared network to facilitate the connection of the open cycle gas turbine power station,where the IMO may seek a reasonable estimate of this value from the **Electricity Network Corporation**;
- (d) the cost of acquiring and installing fuel tanks sufficient to accommodate 24 hours of liquid fuel storage including the cost of keeping this tank half full at all times;
- (e) the capital cost of a pipeline lateral of reasonable length to connect to a main gas pipeline (so as to allow for dual fuel capability);
- (f) the estimate of the fixed operating and maintenance costs for a typical open cycle gas turbine power station and the transmission facilities described in (c);
- (g) a margin allowed for legal, approval and financing costs; and
- (h) a margin allowed for contingences.

4.16.5. The IMO must propose a revised value for the Maximum Reserve Capacity Price using the methodology described in Appendix 4.

4.16.6. The IMO must prepare a draft report describing how it has arrived at a proposed revised value for the Maximum Reserve Capacity Price under clause 4.16.5. The IMO must publish the report on the Market Web-Site and advertise the report in newspapers widely distributed in Western Australia and request submissions from all sectors of the Western Australia energy industry, including end-users.

4.16.7. After considering of the submissions on the draft report described in clause 4.16.6 the IMO must propose a final revised value for the Maximum Reserve Capacity Price and submit that value and its final report, including submissions received on the draft report, to the Economic Regulation Authority for approval.

4.16.8. A proposed revised value for the Maximum Reserve Capacity Price becomes the Maximum Reserve Capacity Price after:

- (a) the Economic Regulation Authority has approved that value in accordance with clause 2.26; and

- (b) the IMO has posted a notice on the Market Web Site of the new value of the Maximum Reserve Capacity Price,
with effect from the time specified in the IMO's notice.

4.17. Reserve Capacity Auction Submission Process

- 4.17.1. The IMO must prescribe a Reserve Capacity Auction form and post it on the Market Web Site.
- 4.17.2. A Market Participant submitting a Reserve Capacity Offer must submit the information specified in clause 4.18 using the Reserve Capacity Auction form by mailing or faxing it to the IMO during the period specified in clause 4.1.17.
- 4.17.3. Upon receipt of a Reserve Capacity Offer, the IMO must within one Business Day contact the Market Participant by facsimile or e-mail to confirm receipt, and whether it has accepted the offer as valid or rejected the offer as invalid, with reasons for rejection provided.
- 4.17.4. The IMO may reject a Reserve Capacity Offer if:
 - (a) the offer is inconsistent with the requirements of these Market Rules, including clause 4.14.10;
 - (b) the offer does not contain any of the information specified in clause 4.18; or
 - (c) the offer is not in the form required by clause 4.17.2.

Note that one Business Day for validation should be satisfactory. An offer should only comprise a small amount of information as described in clause 4.18 and all the IMO needs to do is to verify that the numbers are consistent with certified capacities held and offer price limits. Making this several Business Days would not make any real difference to the process.

- 4.17.5. A Market Participant that does not receive confirmation of receipt of a Reserve Capacity Offer within the time specified in clause 4.17.3 must contact the IMO to arrange for resubmission of the Reserve Capacity Offer.
- 4.17.6. A Market Participant may not revise or resubmit a Reserve Capacity Offer after the IMO has confirmed receipt of the Reserve Capacity Offer in accordance with clause 4.17.3.
- 4.17.7. Subject to clause 4.17.8, a Market Participant may only resubmit a Reserve Capacity Offer in the event that:
 - (a) the IMO fails to acknowledge receipt of a Reserve Capacity Offer; or
 - (b) the IMO rejects the Reserve Capacity Offer under clause 4.17.3.

Chapter 4

4.17.8. The IMO may not accept a Reserve Capacity Offer submitted outside the interval specified in clause 4.1.17.

This means that Market Participants should not wait for the last possible moment to submit offers, as if they fail to be accepted and submissions are closed, then there is nothing that can be done.

4.17.9. The IMO must document the Reserve Capacity Auction submission and clearing process in the Reserve Capacity Procedure, and the IMO and Market Participants must follow that documented Market Procedure.

4.18. Reserve Capacity Offer Format

4.18.1. A Reserve Capacity Offer must include the following information:

- (a) the identity of the Market Participant submitting the Reserve Capacity Offer;
- (b) the identify of the Market Participant's Facility covered by the Reserve Capacity Offer; and
- (c) a single Price-Quantity Pair for each Facility except for Interruptible Loads, Curtailable Loads and Dispatchable Loads, where a single Price-Quantity Pair is to be included for each block of Certified Reserve Capacity associated with the Facility.

The intention is that a single Reserve Capacity Offer can cover more than one Reserve Capacity Facility. But each Price-Quantity Pair in that offer must be associated with a specific facility, or in the case of DSM, one of the up to 3 allowed capacity blocks. But this does not preclude Market Participants from submitting a separate Reserve Capacity Offer for each facility (it might just mean more paper work).

Only one Price-Quantity Pair is specified per Reserve Capacity Facility (excluding DSM) as the facility, is either scheduled in its entirety (after allowing for bilateral trades) or not at all. In the case of DSM, it is recognised that a single facility may offer different levels of availability of DSM, and as such one offer per block of availability is allowed.

4.18.2. Each Reserve Capacity Price-Quantity Pair must comprise:

- (a) the identity of the Facility to which it relates;
- (b) an offer price in units of dollars per megawatt per year expressed to a precision of \$0.01/MW between zero and the Maximum Reserve Capacity Price;
- (c) a quantity in units of megawatts equal to the amount determined in accordance with clause 4.14.10 in respect of that Facility; and
- (d) if the Facility is an Interruptible Load, Curtailable Load or Dispatchable Load, the Availability Class of that Price-Quantity Pair, as specified by the IMO in

assigning Certified Reserve Capacity to that Facility in accordance with clause 4.11.

4.19. Reserve Capacity Auction Clearing

4.19.1. The IMO, by the time and date specified in clause 4.1.18, must process the Reserve Capacity Offers applying the methodology set out in Appendix 3 and determine the Reserve Capacity Auction result in accordance with the objective set out in clause 4.19.2.

4.19.2. The objective of a Reserve Capacity Auction is to meet the Reserve Capacity Requirement for the Reserve Capacity Cycle, or, if it is not possible to meet the Reserve Capacity Requirement, then minimise the shortfall.

4.19.3. If Reserve Capacity Offers exist from two or more Facilities that cannot simultaneously be scheduled (for example, because more than one Market Participant is proposing to build a Facility that will be located at the same site), then the IMO must:

- (a) not accept any Reserve Capacity Offer from any such Facility unless the IMO has either accepted a non-zero value for that Facility under clause 4.14.6 or has not accepted a non-zero value for any Facility under clause 4.14.6; and

If there are 3 facilities that are offering capacity to be located at one site. If one of those facilities is partially covered by a bilaterally trade approved under 4.14.6 then only its offer will be considered. However, if none of the facilities were approved for bilateral trade then clause (a) has no effect.

- (b) Subject to paragraph (a), apply the methodology set out in Appendix 3 for each permutation of such Facilities. The Reserve Capacity Auction result will be:
 - i. if no result meets the Reserve Capacity Requirement, then the result that minimises the shortfall;
 - ii. if one or more results meets the Reserve Capacity Requirement, then, of those results, the result which produces the least value for the sum over all Reserve Capacity Offers of the offer price multiplied by the quantity of capacity scheduled from that Reserve Capacity Offer.

Suppose facilities 1,2,3 and 4 are offered into the auction – but facilities 1 and 2 are unbuilt facilities which, if accepted, will be at the same site. We run the auction for each of the following combinations of facilities {1,3,4} and {2,3,4}. The solution that produces the lowest cost while meeting the requirements, or failing that minimises the shortfall, will be the official result.

4.19.4. A Reserve Capacity Auction result comprises a list of Reserve Capacity Offers scheduled and a Reserve Capacity Price.

Chapter 4

4.19.5. The IMO must publish:

- (a) the Reserve Capacity Price included in the Reserve Capacity Auction results determined in accordance with clause 4.19.1; and
- (b) the quantity of Certified Reserve Capacity scheduled from each Facility registered by each Market Participant in the Reserve Capacity Auction results determined in accordance with clause 4.19.1,

by the time and date specified in clause 4.1.18.

Capacity Credits

4.20. Capacity Credits

4.20.1. Each Market Participant must, by the date and time specified in clause 4.1.20, notify the IMO of:

- (a) the total number of Capacity Credits each Facility will provide during the Capacity Year commencing on 1 October of Year 3 of the Reserve Capacity Cycle; and
- (b) the number of those Capacity Credits the Market Participant anticipates the IMO has acquired as a result of the Reserve Capacity Auction,

“Anticipates” is used because while the IMO has acquired Capacity Credits that participate in the auction, it may subsequently acquire Capacity Credits from those who planned to trade bilaterally to the extent that their bilateral trades do not eventuate.

subject to the following:

- (c) the total number of Capacity Credits provided by all the Market Participant's Facilities must be consistent with the sum of:
 - i. the quantity of Certified Reserve Capacity held by the Market Participant which the IMO has notified the Market Participant it can trade bilaterally under clause 4.14.9;
 - ii. the quantity of Certified Reserve Capacity held by the Market Participant scheduled by the IMO in the Reserve Capacity Auction, as published in accordance with clause 4.19.5(b);
 - iii. the quantity of Certified Reserve Capacity held by the Market Participant which remains the subject of pre-existing Long Term Special Price Arrangements and which the Market Participant does not intend to trade bilaterally; and
 - iv. the quantity of Certified Reserve Capacity held by the Market Participant for Facilities subject to Network Control Service Contracts.

The clause above relates to the total Capacity Credits held by a Market Participant. The clause below relates to the subset of those Capacity Credits which are anticipated to be

Chapter 4

funded by the IMO. "Anticipated" is used because the IMO will fund Capacity Credits subject to bilateral trade if the bilateral arrangement ceases.

- (d) the total number of Capacity Credits which the Market Participant anticipates will be acquired by the IMO from the Market Participant must be consistent with
- i. the quantity of Certified Reserve Capacity held by that Market Participant and scheduled by the IMO in the Reserve Capacity Auction, as published in accordance with clause 4.19.5(b);
 - ii. the quantity of Certified Reserve Capacity held by the Market Participant which remains the subject of pre-existing Long Term Special Price Arrangements and which the Market Participant intends not to trade bilaterally;
 - iii. plus the quantity of Certified Reserve Capacity held by the Market Participant for Facilities to be subject to Network Control Service Contracts except where these are to be traded bilaterally as defined in clause 4.14.2; and

Thus facilities holding Certified Reserve Capacity and covered by a Network Control Service Contract will be price-takers in the auction. However, they can trade that capacity bilaterally if they wish. They are treated differently from others because these facilities are granted Capacity Credits automatically irrespective of how they want to trade it.

- (e) Certified Reserve Capacity of one Facility granted approval to trade bilaterally under clause 4.14.9 or scheduled by the IMO in the Reserve Capacity Auction can be provided as Capacity Credits by another Facility registered by the Market Participant covered by a Reserve Capacity Offer submitted by the Market Participant for the auction, but which was not scheduled, provided that the Reserve Capacity is in the same Availability Class or an Availability Class with greater availability than the Availability Class of the Reserve Capacity provided by the original Facility.

Clause (e) means that it is possible to transfer scheduled Capacity Credits from one facility that offered those credits into the auction to another facility that offered its credits. They cannot be transferred to a facility that did not participate in the auction (since they are assumed to be selling Capacity Credits bilaterally). Clause 4.12.6 will cause the Reserve Capacity Obligation Quantity of a facility to be adjusted to reflect the Capacity Credits associated with it. Availability Classes have been added to this clause to stop reserve capacity from a facility that is available in all hours from being transferred to a facility that is only available for 10 hours.

4.20.2. The IMO must consider each notice it receives under clause 4.20.1 and notify the relevant Market Participant whether it confirms or rejects the notification within one Business Day.

Chapter 4

4.20.3. The IMO may only reject a notice under clause 4.20.1 if the notice is inconsistent with these Market Rules.

4.20.4. If the IMO rejects a notice under clause 4.20.1, then it must give the relevant Market Participant its reasons for doing so.

4.20.5. If the IMO rejects a notice under clause 4.20.3, then the Market Participant must re-submit the notice as soon as practicable, incorporating any amendments suggested by the IMO, and clauses 4.20.2 to 4.20.4 also apply to the re-submitted notice.

4.20.6. For the purpose of this clause 4.20, Capacity Credits associated with Certified Reserve Capacity issued to Western Power in accordance with clause 4.11.7 are to be associated with the generation portfolio the capacity of which contributes to the Certified Reserve Capacity issued under clause 4.11.7 rather than to the individual Facilities comprising that portfolio.

Special Price Arrangements

4.21. Short Term Special Price Arrangements

This type of Special Price Arrangement only applies to facilities scheduled out of merit order in the auction and has a term of one year. This is just a “catch all” and it is quite possible that this feature will never be used.

4.21.1.

- (a) The IMO is to grant Short Term Special Price Arrangements to a Market Participant in respect of any Capacity Credits acquired by the IMO as a result of a Reserve Capacity Auction where the offer price in the Reserve Capacity Offer for the Certified Reserve Capacity relating to those Capacity Credits exceeded the Reserve Capacity Auction Price.
- (b) The Special Reserve Capacity Price for Capacity Credits covered by the Short Term Special Price Arrangement is to equal the offer price in the Reserve Capacity Offer for the Certified Reserve Capacity relating to those Capacity Credits.
- (c) The level of coverage of the Short Term Special Price Arrangement is to equal the quantity of Capacity Credits associated with a Reserve Capacity Offer to which paragraph (a) relates, less the quantity of Capacity Credits associated with the same Reserve Capacity Offer which are to be covered by Long Term Special Price Arrangements in accordance with clause 4.22.1.
- (d) The term of a Short Term Special Price Arrangement is the period that the Reserve Capacity Obligations in respect of the Capacity Credits apply as specified in clause 4.1.26 and clause 4.1.30 for the Reserve Capacity Cycle relating to the Reserve Capacity Auction.

4.22. Long Term Special Price Arrangements

4.22.1. Until the date and time specified in clause 4.1.20, a Market Participant may nominate to have Capacity Credits it holds which are acquired by the IMO as a result of the Reserve Capacity Auction for the Reserve Capacity Cycle (other than Capacity Credits provided by another Facility in accordance with clause 4.20.1(e)) covered by a Long Term Special Price Arrangement.

4.22.2. If a Market Participant nominates to have Capacity Credits covered by a Long Term Special Price Arrangement, it must at the same time nominate:

- (a) a level of coverage, in MW and to a precision of 0.005 MW, subject to the limits that:
 - i. if the Capacity Credits are provided by a Facility which has not previously provided Capacity Credits, the number of Capacity Credits covered by the arrangement is not to exceed the total Capacity Credits to be provided by the Facility acquired by the IMO as a result of the Reserve Capacity Auction for the Reserve Capacity Cycle determined in accordance with clause 4.20;
 - ii. if the Capacity Credits are provided by a Facility which has previously provided Capacity Credits, the number of Capacity Credits covered by the arrangement is not to exceed the lesser of:
 - 1. the total Capacity Credits provided by the Facility acquired by the IMO as a result of the Reserve Capacity Auction for the Reserve Capacity Cycle determined in accordance with clause 4.20; and
 - 2. the increase in the number of Capacity Credits provided by the Facility, whether acquired by the IMO or traded bilaterally, since the previous Reserve Capacity Cycle.

Where the Long Term Special Price Arrangement is conditional on evidence being provided to the IMO prior to that Long Term Special Price Arrangement taking effect that capital costs in excess of 10% of the Maximum Reserve Capacity Price have been incurred on average with respect to the provision of each Capacity Credit covered by the arrangement

- (b) the term for the Long Term Special Price Arrangement, which must commence on the Reserve Capacity Obligation commencement date determined in accordance with clause 4.1.26 for the Reserve Capacity Cycle, end at the completion of a Trading Day ending on 1 October and shall not exceed:
 - i. in the case of Long Term Special Price Arrangements nominated in respect of the first Reserve Capacity Cycle, 15 years;

Chapter 4

The logic for consideration of a longer period is that there is no market history for new entrants to refer to and they may want greater certainty.

- ii. in the case of Long Term Special Price Arrangements nominated in respect of any subsequent Reserve Capacity Cycle, 10 years.

4.22.3. Special Reserve Capacity Price for Capacity Credits covered by a Long Term Special Price Arrangement is:

- (a) in the first Capacity Year of the Long Term Special Price Arrangement, the Monthly Reserve Capacity Price applicable in the first Trading Month of the term of the Long Term Special Price Arrangement; and
- (b) in each subsequent Capacity Year of the Long Term Special Price Arrangement, the price calculated in accordance with the following formula:

$P[t] = P[t-1]$ multiplied by the greater of

unity, and

$$(1 + ((CPI[t] - CPI[t-1]) / CPI[t-1]) - 0.01)$$

for $t > 0$

This equation has been modified so that if CPI were to fall dramatically over time, the price paid for capacity cannot become negative. This is unlikely to ever be the case, but this feature is included for the avoidance of doubt.

Where

t indicates the number of years that have elapsed since the commencement of the Long Term Special Price Arrangement where t has a value of 0 in the first Capacity Year and increases by 1 for each subsequent Capacity Year;

$P[0]$ is the Monthly Reserve Capacity Price applicable in the first Trading Month of the term of the Long Term Special Price Arrangement;

$P[t]$ is the Special Reserve Capacity Price applicable for the t th Capacity Year; and

$CPI[t]$ is the weighted average of the Consumer Price Index All Groups values for the eight Australian State and Territory capital cities as determined by the Australian Bureau of Statistics for the quarter ending June 30 of the calendar year in which the t th Capacity Year commences; and

$CPI[t-i]$ is the weighted average of the Consumer Price Index All Groups values for the eight Australian State and Territory capital cities as determined by the Australian Bureau of Statistics for the quarter ending on June 30 of the preceding calendar year.

Chapter 4

4.22.4. The quantity of Capacity Credits covered by a Long Term Special Price Arrangement is the lesser of:

- (a) the level of coverage specified in accordance with clause 4.22.2(a);
- (b) the Capacity Credits held by the Market Participant for the Facility in the Trading Month; and
- (c) the Capacity Credits allocated to the relevant Long Term Special Price Arrangement in accordance with clause 4.22.6.

Long Term Special Price Arrangements are irreversible to stop generators staying under a Special Price Arrangement when it returns a higher Special Reserve Capacity Price than the prevailing Monthly Reserve Capacity Price but then discarding the Special Price Arrangement if the Monthly Reserve Capacity Price exceeds the Special Reserve Capacity Price. However, if the capacity is traded bilaterally in some future year, then the Special Price Arrangement does not apply to the capacity covered by the bilateral arrangement.

4.22.5. A Market Participant, in relation to Certified Reserve Capacity associated with Capacity Credits covered by a Long Term Special Price Arrangement:

- (a) must not include that Certified Reserve Capacity in Reserve Capacity Offers during the term of the Long Term Special Price Arrangement; and
- (b) must still annually re-apply for certification in accordance with clause 4.9 during the term of the Long Term Special Price Arrangement.

4.22.6. If more than one Long Term Special Price Arrangement is associated with a single Facility, then:

- (a) subject to paragraph (b), the Capacity Credits held by the Market Participant provided by the Facility in each Reserve Capacity Cycle are to be allocated to those Long Term Special Price Arrangements in order of the commencement date of each Long Term Special Price Arrangement, starting with the Long Term Special Price Arrangement with the earliest commencement date which has not expired and so on until all of the Capacity Credits have been allocated; and
- (b) the amount of the Capacity Credits provided by the Facility to be allocated to each Long Term Special Price Arrangement in each Reserve Capacity Cycle is not to exceed the quantity specified as being covered by that Long Term Special Price Arrangement in accordance with clause 4.22.2(a).

Suppose a generator takes up the following Long Term Special Price Arrangements: 4 MW in 2006, 4 more MWs in 2008 and a further 2 MW in 2010. Each of these Long Term Special Price Arrangements is for 10 years. If, in 2012 the Certified Reserve Capacity of the facility were only 7 MW, so it could only hold 7 MW of Capacity Credits then 4 MW of those Capacity Credits would be settled at the price of the 2006 Special Price Arrangement, 3 MW

Chapter 4

of those Capacity Credits would be settled at the price of the 2008 Special Price Arrangement, and none would be settled at the 2010 Special Price Arrangement price.

4.23. Capacity Credits and Force Majeure

4.23.1. There are no force majeure conditions associated with Capacity Credits.

The intention is that there is no basis for claiming force majeure. This reflects the fact that if a Reserve Capacity provider fails to ever meet its capacity obligations then ultimately all it stands to lose are the payments for that Reserve Capacity.

4.23A. Capacity Credits and Facility Registration

At the time of registering facilities, Western Power or the Electricity Generation Corporation (as applicable) may wish to aggregate generating units. This is allowed under the facility registration rules. Capacity Credits and Reserve Capacity Obligation Quantities are only associated with facilities at the time of registration so any facility aggregation can be allowed for.

4.23A.1. For the first Reserve Capacity Cycle, as facilities are registered, the IMO must convert the Certified Reserve Capacity, Capacity Credits and Reserve Capacity Obligation Quantities that were associated with Western Power's generation systems in accordance with clauses 4.11, 4.12, and 4.20 into Certified Reserve Capacity, Capacity Credits and Reserve Capacity Obligation Quantities associated with individual Registered Facilities.

4.23A.2. In performing the allocations described in clause 4.23A.1, the IMO must:

- (a) ensure that the total Certified Reserve Capacity, Capacity Credits and Reserve Capacity Obligation Quantities of the Registered Facilities equal, respectively, the Certified Reserve Capacity, Capacity Credits and Reserve Capacity Obligation Quantities that were associated with Western Power's generation systems in accordance with clauses 4.11, 4.12, and 4.20;
- (b) where facilities will not be registered as being Electricity Generation Corporation facilities as at Energy Market Commencement, allocate Certified Reserve Capacity, Capacity Credits and Reserve Capacity Obligation Quantities to the Market Participant to whom those facilities are to be registered; and
- (c) consult with Western Power or the Electricity Generation Corporation (as applicable) and give consideration to Western Power or the Electricity Generation Corporation (as applicable) preferences as to how clause 4.23A.1 should be implemented.

4.23A.3. If at any time a Market Participant holds Capacity Credits with respect to a facility (the "primary facility") that must be registered as more than one Registered Facility, either as a result of Facility aggregation not being approved by System

Management or being revoked, then the IMO may re-allocate the Certified Reserve Capacity, Capacity Credits and Reserve Capacity Obligation Quantities of the primary facility between the primary facility and the Registered Facilities subject to the conditions that:

- (a) the Registered Facilities were documented in the original application for Certified Reserve Capacity as contributing to the capacity covered by those Capacity Credits;
- (b) the IMO must not allocate more Certified Reserve Capacity, Capacity Credits or Reserve Capacity Obligation Quantity to a Registered Facility than that Registered Facility can provide based on information provided in the original application for Certified Reserve Capacity for the primary facility;
- (c) after the re-allocation the total Certified Reserve Capacity, the total number of Capacity Credits and the total Reserve Capacity Obligation Quantities, respectively, of the primary facility and the Registered Facilities must equal the Certified Reserve Capacity, the number of Capacity Credits, and the Reserve Capacity Obligation Quantity original held by the primary facility; and
- (d) the IMO must consult with the applicable Market Participant and give consideration to its preferences in the re-allocations to the extent allowed by (a), (b) and (c).

Addressing Shortages of Reserve Capacity

4.24. Supplementary Reserve Capacity

Supplementary Capacity Contracts will be required if there is not enough capacity procured at the time of the Reserve Capacity auction, or if the Capacity Credits available from a facility are reduced because of a permanent de-rating. However, it is not the intent that Supplementary Capacity Contracts will be entered into simply because one or more large generating units is temporarily unavailable due to a forced outage. To do so, would imply a higher security standard than embodied in these rules.

The intention is that only consumers and small, unregistered generating facilities can provide Supplementary Capacity. Consumers would effectively be paid to reduce their demand for a period of time, which could be achieved by running on-site emergency back-up generators, or cutting back on consumption etc. This Supplementary Capacity is provided for a shorter term and is expected to be paid a higher price per Trading Interval than normal Reserve Capacity Price. The idea behind excluding large generators from providing this Reserve Capacity is that such generators should only have one auction into which to sell their capacity – the main Reserve Capacity Auction. If they have a choice of two auctions, then they might deliberately withhold capacity from the first auction, causing a shortage and raising expectations of high Reserve Capacity Prices, and then force up the price in the second auction without having the corresponding obligations of the main auction.

Chapter 4

4.24.1. If, at any time after the day which is six months before the first Capacity Year the IMO considers that, in its opinion, inadequate Reserve Capacity will be available in the SWIS to satisfy the requirements described in clauses 4.5.9(a) and (b), and Reserve Capacity Auction intended to secure Capacity Credits for that time has already occurred or been cancelled, then it must:

- (a) determine the expected start and end dates for the period of the shortfall;
- (b) determine the expected amount of the shortfall; and
- (c) seek to acquire supplementary capacity in accordance with clause 4.24.2.

4.24.2. If the IMO decides to seek to acquire supplementary capacity and:

- (a) the expected start date of the shortfall is at least 12 weeks from the date the IMO becomes aware of the shortfall, then it must call for tenders from potential suppliers of supplementary capacity in an invitation to tender;

4 weeks appeared in the above clause previously, but experience from Victoria suggests that 12 weeks might be more appropriate.

- (b) paragraph (a) does not apply, then it must either:
 - i. call for tenders from potential suppliers of supplementary capacity in an invitation to tender; or
 - ii. negotiate directly with potential suppliers of supplementary capacity.

4.24.3. The only eligible sources of supplementary capacity are the following services ("**Eligible Services**"):

- (a) load reduction, that is measures to reduce a consumer's consumption of electricity supplied through the SWIS, but excluding reductions associated with the operation of Registered Facilities (including registered Loads); and
- (b) the generation of electricity by generation systems that are not Registered Facilities.

4.24.4. A person is not required to be a Rule Participant in order to submit a tender in response to a call for tenders under clause 4.24.2 or enter into a Supplementary Capacity Contract with the IMO. However, if a Rule Participant does enter into a Supplementary Capacity Contract with the IMO, then it must comply with that contract.

4.24.5. The IMO must not call for tenders for supplementary capacity earlier than six calendar months prior to the calendar month in which the shortfall period is expected to start.

The six month limit as to how early a tender can be held is included because it is expected to be difficult to get commitment from consumers as to how much load they can afford to curtail over longer lead times.

Chapter 4

4.24.6. If the IMO decides to call for tenders for supplementary capacity, then, no earlier than 30 Business Days and no later than 10 Business Days prior to the proposed closing date for submission of tenders, the IMO must advertise the call for tenders on the Market Web Site and in major local and national newspapers. The advertisement must include:

- (a) the date and time at which any person wishing to tender to supply Eligible Services must have completed and lodged with the IMO the form specified in clause 4.24.7;
- (b) contact details for the IMO;
- (c) the amount of capacity required;
- (d) the number of hours over which the capacity is expected to be used;
- (e) the time of the day where the capacity is expected to be required;

E.g. between 9 AM and 3 PM.

- (f) the expected term of any Supplementary Capacity Contracts entered into as a result of the call for tenders;
- (g) the maximum contract value per hour of availability for any Supplementary Capacity Contract that the IMO will accept;

A process for determining the price cap for Supplementary Capacity Contracts will eventually be added to the rules/procedures. These amendments are not urgently required as it will not be possible under these Market Rules to tender for a Supplementary Capacity Contract until the start of 2006.

- (h) the location of copies of the standard Supplementary Capacity Contracts on the Market Web Site; and
- (i) the location on the Market Web Site of the tender form to be used in applying to provide Eligible Services.

4.24.7. The IMO must prescribe the tender form to be used by those applying to provide Eligible Services. This form must require the specification of:

- (a) the name and contact details of the applicant;
- (b) the nature of the Eligible Service to be provided;
- (c) the amount of the Eligible Service available;
- (d) the maximum number of hours over the term of the Supplementary Capacity Contract that the Eligible Service will be available;
- (e) the maximum number of hours on each day during the term of the Supplementary Capacity Contract that the Eligible Service will be available;
- (f) the time of each day during the term of the Supplementary Capacity Contract that the Eligible Service will be available;

Chapter 4

While (e) might state that the capacity is available for 1 hour of the day, this clause might state the capacity can be called any time between 9 AM and 3 PM.

- (g) any information required to complete the relevant standard form Supplementary Capacity Contract for the Eligible Service and the applicant, together with full details of any amendments to the standard form Supplementary Capacity Contract required by the applicant;
- (h) the mechanism for activating the Eligible Service;
- (i) the mechanisms available for measuring the Eligible Service provided; and
- (j) the values of
 - i. the availability price for the Eligible Service expressed in dollars; and
 - ii. the activation price for the Eligible Service, expressed in dollars per hour of activation, where this price must reflect direct or opportunity costs incurred,

where the activation price plus :

- iii. the availability price; divided by
- iv. the lesser of:
 - 1. the number of hours specified in the advertisement for the call for tenders under clause 4.24.6(d); and
 - 2. the number of hours specified for the Eligible Service in accordance with paragraph (d),

must not exceed the maximum contract value per hour of availability specified in the advertisement for the call for tenders under clause 4.24.6(g).

4.24.8. In determining the result of a call for tenders and entering into Supplementary Capacity Contracts:

- (a) the IMO must only accept an offer for the provision of Eligible Services;
- (b) the IMO must not accept an offer for the provision of an Eligible Service if the IMO is not satisfied that the Eligible Service will be available during times of system peak demand coinciding with the shortfall period; and
- (c) subject to the preceding paragraphs and clause 4.24.9, the IMO is to seek to enter into the lowest cost mix of Supplementary Capacity Contracts that:
 - i. will meet the requirement for supplementary capacity; or
 - ii. will, if it is not possible to meet requirement for supplementary capacity, minimise the remaining Reserve Capacity shortfall,

where the cost of each Supplementary Capacity Contract is to be defined to be the sum of:

- iii. the availability price; plus

Chapter 4

- iv. the product of the activation price and the lesser of:
 - 1. the number of hours specified in the advertisement for the call for tenders under clause 4.24.6(d); and
 - 2. the number of hours specified for the Eligible Service in the relevant tender form in accordance with clause 4.24.7(d).

Note that there is no restriction on indicating that Supplementary Capacity will be available for more hours than is required. This allows people to say the capacity is available every day, if they want. However, in assessing the value of the contract, we will never count more hours than allowed under (1).

4.24.9. The IMO is not under any obligation to accept any tender, or enter into a Supplementary Capacity Contract in respect of any tender, made in response to a call for tenders under clause 4.24.2.

4.24.10. If the IMO negotiates directly with a potential supplier of Eligible Services in accordance with clause 4.24.2(b)(ii), then it must provide the following information to the potential supplier:

- (a) the amount of capacity required;
- (b) the relevant standard form Supplementary Capacity Contract; and

There is no value in specifying a maximum contract value if the IMO is negotiating bilaterally.

- (c) details of the information to be provided by the potential supplier, including:
 - i. the amount of the Eligible Service available;
 - ii. the mechanism for activating the Eligible Service;
 - iii. the mechanisms available for measuring the Eligible Service provided;
 - iv. the availability price for the Eligible Service expressed in dollars; and
 - v. the activation price for the Eligible Service, expressed in dollars per hour of activation, where this price must reflect direct or opportunity costs incurred.

4.24.11. Subject to clause 4.24.3, the IMO may at its discretion enter into any negotiated Supplementary Capacity Contract, but must employ reasonable endeavours to minimise the cost of Eligible Services acquired in this manner.

No clause requiring negotiation in good faith has been added as the party with whom the IMO is negotiating may not be party to these Market Rules.

4.24.12. The IMO must develop and maintain a standard form Supplementary Capacity Contract which accords with the requirements in clause 4.24.13.

Chapter 4

4.24.13. A standard form Supplementary Capacity Contract will require the supplier of an Eligible Service to reduce net consumption, or to increase generation, on instruction from System Management and must specify:

- (a) that there are no force majeure conditions;

Force Majeure conditions are not required as if the provider never once provides the supplementary capacity then the most extreme consequence is that they lose the full value of their supplementary capacity payments.

- (b) the settlement process to be followed, including timing of payments;
- (c) contract variation conditions;

This would address factors that could result in the obligations or payments being reduced.

- (d) any conditions required to ensure that if a different person takes over the facility used to provide the Eligible Service, that the person taking over will be bound by the contract obligations (for example, by requiring the execution of a deed of assumption or novation);
- (e) the financial consequences of failing to supply the Eligible Service in accordance with the contract, based on the arrangements which apply under clause 4.26 where a Market Participant holding Capacity Credits for a Facility fails to comply with its Reserve Capacity Obligations;
- (f) a condition allowing the IMO to disclose the information required by clause 2.24.13 and preventing the disclosure set out in clause 2.14.14;
- (g) the technical standards and verification arrangements which facilities used to provide Eligible Services must comply with; and
- (h) blank schedules specifying:
 - i. the term of the Supplementary Capacity Contract, where this term is not to exceed 12 weeks;
 - ii. the sources of the net consumption reduction or generation increase;
 - iii. the amount of net consumption reduction or generation increase required;
 - iv. the notification time to be given for activation;
 - v. the method of notification of activation;
 - vi. the minimum duration of any activation;
 - vii. the maximum duration of any single activation;
 - viii. any limits on the number of times System Management can request activation;
 - ix. the basis to be used for measuring the response;

Chapter 4

- x. the availability price;
- xi. the activation price;
- xii. technical matters relating to the facility (including testing); and
- xiii. the fact that activation instructions will be given by System Management.

The standard form may contain different terms depending on the type and location of facility used to provide the Eligible Service, the service provider or other relevant factors.

While the costs of supplementary capacity will be recovered under the rules, the suppliers will be paid by the IMO outside of the normal settlement process (since some suppliers may not be market participants).

4.24.14. Despite the existence of the standard form Supplementary Capacity Contract, the IMO may enter into Supplementary Capacity Contracts in any form it considers appropriate.

4.24.15. The IMO must recover the full cost it incurs in respect of Supplementary Capacity Contracts in accordance with clause 4.28 and Chapter 9.

This is intended to cover the costs of the procurement process

4.24.16. The IMO must provide the following Supplementary Capacity Contract information to System Management, so as to allow System Management to dispatch the contracted Eligible Services:

- (a) the identity of each contracted Eligible Service, listed in order of increasing activation price;
- (b) the information required to contact the party which will activate the Eligible Service;
- (c) the process to be followed in activating that Eligible Service, including required advance notification times; and
- (d) the limitations on the availability of the Eligible Service.

4.24.17. The IMO must not provide the following Supplementary Capacity Contract information to System Management for any Eligible Service:

- (a) the activation price for that Eligible Service; or
- (b) the availability price for that Eligible Service.

4.24.18. The IMO must document the procedures it follows in:

- (a) acquiring Eligible Services;
- (b) entering into Supplementary Capacity Contracts;

- (c) determining the maximum contract value per hour of availability for any Supplementary Capacity Contract,
- in the Reserve Capacity Procedure, and the IMO and System Management must follow that documented Market Procedure.

Testing, Monitoring and Compliance

4.25. Reserve Capacity Testing

Testing has two purposes. The first is to test that the facility is actually operational when it says it is operational. The second is to provide a source of data for adjusting the capacity-temperature trade-off function for facilities that have temperature dependent capacity.

4.25.1. The IMO must take steps to verify, in accordance with clause 4.25.2, that each Facility providing Capacity Credits:

- (a) can, during the term the Reserve Capacity Obligations apply, operate at its maximum Reserve Capacity Obligation Quantity at least once during each of the following periods and in the case of a generation system, such operation must be achieved on each type of fuel available to that Facility notified under clause 4.10.1(e)(v):
- i. 1 October to 31 March; and
 - ii. 1 April to 30 September; and

The requirement is that the facility operates at its MAXIMUM Reserve Capacity Obligation Quantity. That is, if under optimum temperatures etc, the facility should be able to produce 40 MW then it must be seen to do that once in each of the above periods. This will generally imply that these tests be conducted on cooler days.

- (b) can, during the six months prior to the Reserve Capacity Obligations for the first Reserve Capacity Cycle taking effect, operate at its maximum Reserve Capacity Obligation Quantity at least once and, in the case of a generating system, such operation on each type of fuel available to that Facility notified under clause 4.10.1(e)(v). This paragraph (b) does not apply to facilities that are not commissioned prior to their Reserve Capacity Obligations coming into force.

This clause (b) provides a mechanism for verifying the ability of a facility to provide capacity prior to the first time its obligations take effect for the first Reserve Capacity Cycle. This is not required for subsequent Reserve Capacity Cycles as testing will have been incurring in previous cycles.

4.25.2. The verification referred to in clause 4.25.1 can be achieved:

Chapter 4

- (a) by the IMO observing the Facility operate at the required level at least once as part of normal market operations in Metered Schedules specific to the Facility; or

If the Electricity Generation Corporation generators do not have settlement quality meters then clause (a) will not apply to them. They will have to conduct tests in accordance with (b) based on operational meter data, as is currently the practice.

Note also that clause (a) also applies to Interruptible and Curtailable Loads, so no testing will be required of them under (b) if they are called during a six month interval.

- (b) by the IMO:
 - i. in the case of a generation system, requiring System Management in accordance with clause 4.25.7 to test the Facility's ability to operate at the required level for not less than 60 minutes and the Facility successfully passing that test; and
 - ii. in the case of Interruptible Loads, Curtailable Loads and Dispatchable Loads, requiring System Management, in accordance with clause 4.25.7, to test the process and systems to activate a reduction in demand without requiring demand to actually reduce, and the Facility successfully passing that test.

4.25.3. The IMO must not subject a Facility to more tests of Reserve Capacity than it considers are required to satisfy the verification requirements of this clause 4.25.

4.25.3A. The IMO must not subject a Facility to a test of Reserve Capacity if that Facility is:

- (a) undergoing a Scheduled Outage or Opportunistic Outage which has been approved in accordance with clause 3.19, or
- (b) if the facility has advised System Management of a Forced Outage or Consequential Outage in accordance with clause 3.21.4; or
- (c) if the Facility is undergoing Commissioning Test approved in accordance with clause 3.21A.

4.25.4. The IMO must, in the event that a Facility fails a Reserve Capacity test under clause 4.25.2(b), require System Management to re-test that Facility in accordance with clause 4.25.2(b), not earlier than 14 days and not later than 28 days after the first test. If the Facility fails this second test, then the IMO must, from the next Trading Day:

- (a) if the test related to a generation system, reduce the number of Capacity Credits held by the relevant Market Participant for that Facility to reflect the maximum capabilities achieved in either test performed (after adjusting these results to the equivalent values at a temperature of 41°C and allowing for the capability provided by operation on different types of fuels); or

Chapter 4

- (b) if the test related to a Dispatchable Load, Curtailable Load or Interruptible Load, reduce the number of Capacity Credits held by the relevant Market Participant for that Facility to zero;

Note the treatment of Dispatchable Loads, Curtailable Loads and Interruptible Loads – for (b) to apply the load will have had to have not been called in a six month period under normal market processes and have failed 2 tests. Also note that while Dispatchable Loads are treated like generators in the energy market, they are treated like loads for the purpose of Reserve Capacity (since they provide capacity by reducing consumption).

Where Capacity Credits are reduced, the Reserve Capacity Obligations are revised under clause 4.12.6.

- 4.25.5. In the event that the number of Capacity Credits held by a Market Participant are reduced in accordance with clause 4.25.4, then that Market Participant may request once during the remaining Reserve Capacity Cycle that the IMO require System Management to perform a single re-test to be conducted during the seven days following that request.
- 4.25.6. If the IMO receives a request for a Reserve Capacity re-test in accordance with clause 4.25.5, then the IMO must require System Management to conduct such a re-test, and must set the number of Capacity Credits held by the relevant Market Participant for that Facility to reflect the maximum capabilities achieved in the re-test (after adjusting these results to the equivalent values at a temperature of 41°C and allowing for the capability provided by operation on different types of fuel), but not to exceed the number of Capacity Credits originally confirmed by the IMO for that Facility under clause 4.20 in respect of the relevant Reserve Capacity Cycle.
- 4.25.7. In requesting System Management to conduct a test, the IMO must provide System Management with the following information:
 - (a) the Facility to be tested;
 - (b) the fuel to be used by the Facility during the test where applicable; and
 - (c) the time interval during which the test is proposed to be conducted, where this interval must begin not less than two Business Days after the time the IMO issues the request to System Management.
- 4.25.8. If the IMO requests that a test be conducted by System Management in accordance with this clause 4.25, then System Management must notify the IMO within one Business Day as to whether it is possible to conduct the test without endangering Power System Security and Power System Reliability within the time interval described in clause 4.25.7(c), and if not, System Management must provide to the IMO:
 - (a) justification as to why the test cannot be conducted; and

Chapter 4

- (b) an alternative time interval during which the test will be conducted, where this must be the earliest time that the test can be performed without endangering Security and Power System Reliability.

4.25.9. In conducting a test, System Management:

- (a) must, subject to paragraphs (b), (c) and (d), endeavour to conduct the test without warning;
- (b) must allow sufficient time for the Market Participant to schedule fuel that it is not required under these Market Rules to be stored on-site
- (c) must allow sufficient time for switching a Facility from one fuel to an alternative fuel if operation using the alternative fuel is being tested;
- (d) must, in the case of an Interruptible Load or a Curtailable Load allow sufficient time for arrangements to be made for the Facility to be triggered in a simulation mode only;
- (e) must report to the IMO whether the test was successful, and if not, report the generation achieved by the Facility during the test;
- (f) must maintain adequate records of the test to allow independent verification of the test results; and
- (g) conduct the test in the time interval specified by the IMO in accordance with clause 4.25.7(c) unless System Management has notified the IMO of an alternative time interval in accordance with clause 4.25.8, in which case, System Management must conduct the test in the time interval specified in accordance with clause 4.25.8(b).

4.25.10. Where a Facility is tested in accordance with this clause 4.25, the Dispatch Schedule for that Facility during the period of the test is to reflect the energy scheduled in the test.

4.25.11. Every three months the IMO must publish details of:

- (a) Facilities tested during the preceding three months; and
- (b) whether any of those tests were delayed by System Management and the reasons for the delay as given by System Management.

The publication of the above information is a means of making System Management's actions towards Market Participant facilities transparent.

4.25.12. The IMO may use the results of tests under this clause 4.25 in respect of a Facility in assigning certified Reserve Capacity and setting Reserve Capacity Obligation Quantities for the Facility for subsequent Reserve Capacity Cycles.

Chapter 4

The fact that the previous clause uses “may” means that the IMO can disregard the test results if there are mitigating circumstances (e.g. the IMO believes any problems have been fixed since the tests).

- 4.25.13. The IMO must monitor at all times the on-site fuel storage of each Scheduled Generator required to comply with clause 4.10.2. The IMO may:
- (a) require the relevant Market Participant to submit a weekly report of the current fuel level;
 - (b) have a representative of the IMO conduct an on-site inspection to verify the fuel storage level; and
 - (c) instruct System Management to use its SCADA systems to monitor the fuel storage level and to report any failure of any Market Participant to comply with clause 4.10.2 to the IMO.

The SCADA systems would be able to sound an alarm if fuel storage falls below the minimum level. It is intended that the use of SCADA systems would be available as an option, however, inspection of facilities is allowed under the Reserve Capacity obligations.

- 4.25.14. The IMO must document the procedure to be followed in performing Reserve Capacity tests in the Reserve Capacity Procedure, and the IMO, System Management, and Market Participants must follow that documented Market Procedure in the performance of Reserve Capacity tests.

4.26. Financial Implications of Failure to Satisfy Reserve Capacity Obligations

- 4.26.1. If a Market Participant holding Capacity Credits fails to comply with its Reserve Capacity Obligations applicable to any given Trading Interval then the Market Participant must pay a refund to the IMO calculated in accordance with the following provisions.

These refunds can be thought of as a “buy back” requirement whereby the provider of Reserve Capacity buys it back for the period it is not available under a pricing arrangement specified prior to entering into the arrangement. The rules of this section are based on the aggregate quantities provided by participants, not the individual facilities. This is done to avoid problems stemming from the fact that the Electricity Generation Corporation generators may not be metered.

Note that the section on Reserve Capacity obligations includes a process for converting MWh meter data into equivalent MW quantities counted towards covering the obligations.

REFUND TABLE

Season	Cold	Intermediate	Hot
Dates	1 April to 30 September	1 October to 30 November	1 December to 31 March
Off-Peak Trading Interval Rate (\$ per MW shortfall per Trading Interval)	$2 \times Y$	$2 \times Y$	$2 \times Y$
Peak Trading Interval Rate (\$ per MW shortfall per Trading Interval)	$8 \times Y$	$8 \times Y$	$8 \times Y$
Maximum Daily Rate (\$ per average MW shortfall per Trading Interval over a Trading Day)	$5 \times Y$	$5 \times Y$	$5 \times Y$
Maximum Seasonal Rate (\$ per average MW shortfall per Trading Interval over a Season)	$0.6 \times Y$	$0.6 \times Y$	$1.8 \times Y$
Maximum Refund	The total value of the Capacity Credit payments paid or to be paid under these Market Rules to the relevant Market Participant for the 12 Trading Months commencing at the start of the Trading Day of the previous 1 October assuming the IMO acquires all of the Capacity Credits held by the Market Participant and the cost of each Capacity Credit so acquired is determined in accordance with clause 4.28.2(b), (c) and (d) (as applicable).		
Where: For an Intermittent Facility that has been commissioned: Y equals 0 For all other facilities, including Intermittent Facilities that have not been commissioned: Y equals the greater of the Reserve Capacity Price and 85% of the Maximum Reserve Capacity Price for the relevant Reserve Capacity Auction expressed as a \$ per MW per Trading Interval figure.			

The change from 90% to 85% in the bottom part of the table has been made to standardise numbers with the Monthly Reserve Capacity Price defined in clause 4.29. The Reserve Capacity Obligation Quantity for intermittent Facilities will be zero once they have been commissioned, so no charge will apply. The logic for this being that the loss of REC payments will be a significant disincentive for Intermittent Generators that do not operate and because the obligations on intermittent resources are simply to run if they can. Note though, that if an Intermittent facility is late in commissioning, then it will be penalised until it is commissioned

The following example illustrates how the table works.

Suppose that a facility is obligated to provide 100 MW of capacity in every Trading Interval of this year. This corresponds to supplying up to 50 MWh per Trading Interval.

Chapter 4

Suppose on a given Trading Day a facility offers only 20 MWh in each of 10 Trading Intervals when it should have offered 50 MWh. This corresponds to shortage of 30 MWh per Trading Interval or 60 MW for each Trading Interval. Suppose Y is \$5/MW/Trading Interval and the shortage occurs during the peak hours of the peak season. The charge that applies is $8 \times Y = \$40$ per MW per Trading Interval. Given that 60 MW of capacity was unavailable for 10 Trading Intervals the total charge is $\$40 \times 10 \times 60 = \$24,000$.

But the daily cap is $5 \times Y = \$25$ /MW/Trading Interval. The average MW short over the day is $(60 \times 10)/48 = 12.5$ MW. That is, on average, the facility falls 12.5 MW short of its requirement in every Trading Interval. Thus the maximum daily charge over 48 Trading Intervals is $12.5 \times 25 \times 48 = \$15,000$. Hence the generator will only be charged \$15,000 for the day rather than \$24,000.

The seasonal and maximum charge caps will have similar effects. The season cap for the hot season is $1.8 \times Y$. At most, this penalty could be applied for 121 days or 5808 trading intervals. The participant would have to refund 10454.4 Trading Intervals worth of payments. The total number of trading intervals in a year is 365 times 48 or 17520, so this refund corresponds to returning 60% of the value of the contract over the year. In the worse case scenario, the season caps for the cold and intermediate seasons cause 30% and 10% of the contract to be refunded respectively. The result should be that the longer non-compliance lasts, the higher the total charge will be (up to the value of the contract), but the rate of growth in charge declines with duration.

4.26.2. The IMO must determine the capacity shortfall (“**Capacity Shortfall**”) in Reserve Capacity supplied by each Market Participant p holding Capacity Credits in each Trading Interval t of Trading Day d and Trading Month m relative to its Reserve Capacity Obligation Quantity as:

$$SF(p,m,d,t) = \text{Max}(\text{RTFO}(p,d,t), \text{RCOQ}(p,d,t) - A(p,d,t)) + \text{Max}(0, B(p,d,t) - C(p,d,t))$$

Very loosely, this equation means that the short fall in a trading interval equals the reserve capacity obligation in that period less the capacity actually made available to the market based on Bilateral Trade, STEM and Resource Plan submissions (A), or the cumulative Forced Outage of the Market Participant in real-time if this is greater than this difference, where any resultant shortfall is then increased by the difference between what the participant was obliged to do based on dispatch instructions (B) that it should have been able to comply with and what it actually did do (C). The Min and Max terms in what follows are set up to ignore situations where a Market Participant provides more than it is required to.

Where

$$A(p,d,t) = \text{Min}(\text{RCOQ}(p,d,t), \text{CAPA}(p,d,t));$$

$$B(p,d,t) = \text{Min}(\text{RCOQ}(p,d,t) - \text{RTFO}(p,d,t), \text{DSQ}(p,d,t));$$

$$C(p,d,t) = \text{Min}(\text{DSQ}(p,d,t), \text{MSQ}(p,d,t) + \text{TOL}(p,d,t));$$

Chapter 4

“A” represents the capacity actually made available via bilateral, STEM and Resource Plan submissions. This capacity is capped by the capacity the participant is obliged to make available.

“B” represents what the participant was dispatched to do, but is capped by the capacity the participant is obliged to make available, less any Forced Outages of which System Management has been notified. Forced outages are removed from this term because they are already accounted for in other terms forming the shortfall.

“C” accounts for the difference between what a participant was dispatched to do and what it actually did. This term addresses the possibility that a participant either does not follow instructions or is incapable of following them because it has had a forced outage which it has not declared.

The TOL term recognises that MSQ must be adjusted by the tolerance that is applied when assessing compliance to dispatch instructions.

$RCOQ(p,d,t)$ is the total Reserve Capacity Obligation Quantity of Market Participant p 's unregistered facilities that have Reserve Capacity Obligations, plus the sum over all of the Registered sum over all of Facilities registered to Market Participant p of the product of the factor described in clause 4.26.2B as it applies to the Registered Facility and the Facility's Reserve Capacity Obligation Quantity in Trading Interval t of Trading Day d ;

$CAPA(p,d,t)$ is for Market Participant p and Trading Interval t of Trading Day d :

- (a) equal to $RCOQ(p,d,t)$ for a Trading Interval where the STEM auction has been suspended by the IMO in accordance with clause 6.10;
- (b) subject to paragraph (a), for the case where Market Participant p is not **the Electricity Generation Corporation**, the sum of:
 - i. the sum of the Reserve Capacity Obligation Quantities in Trading Interval t of that Market Participant's Interruptible Loads and Curtailable Loads; plus

That Interruptible Load and Curtailable Loads cannot meaningfully be offered into the STEM (as the maximum STEM price could be lower than their actual activation cost). Hence we have removed these from the requirement that they be offered into the STEM and have barred them from being included in Resource Plans. They can however be self-dispatched by a market participant based on STEM prices (which counts as meeting the obligations) and must be available to be called by SM in real-time

- ii. the MW quantity calculated by doubling the total MWh quantity of energy sent out during that Trading Interval by Facilities registered by that Market Participant as indicated by the applicable Resource Plan; plus

- iii. the MW quantity calculated by doubling the total MWh quantity covered by the STEM Offers which were not scheduled and the STEM Bids which were scheduled in the relevant STEM Auction, determined by the IMO for that Market Participant under clause 6.9 for Trading Interval t , corrected for Loss Factor adjustments so as to be a sent out quantity in accordance with clause 4.26.2A; plus
- iv. double the total MWh quantity to be provided as Ancillary Services as specified by the IMO in accordance with clause 6.3A.2(e)(i) for that Market Participant corrected for Loss Factor adjustments so as to be a sent out quantity in accordance with clause 4.26.2A; plus
- v. the greater of zero and $(BSFO(p,d,t) - RTFO(p,d,t))$; and

The previous term in the above clause acts to increase the capacity deemed to have been provided by a participant if the participant's real-time level of Forced Outage, $RTFO(p,d,t)$ is lower than its "before the STEM" level of Forced Outage $BSFO(p,d,t)$. This adjustment is made because $BSFO(p,d,t)$ restricts how much capacity a participant can offer in the STEM, but if capacity is returned to service by real-time then that capacity is available to System Management for dispatch in real-time.

- (c) subject to paragraph (a), for the case where Market Participant p is the Electricity Generation Corporation, the sum of:
 - i. the sum of the Reserve Capacity Obligation Quantities in Trading Interval t of that Market Participant's Interruptible Loads and Curtailable Loads; plus
 - ii. the MW quantity calculated by doubling the total MWh quantity of the Net Contract Position quantity of that Market Participant for Trading Interval t , corrected for Loss Factor adjustments so as to be a sent out quantity in accordance with clause 4.26.2A; plus
 - iii. the MW quantity calculated by doubling the total MWh quantity of the STEM Offers which were not scheduled and the STEM Bids which were scheduled in the relevant STEM Auction, determined by the IMO for that Market Participant under clause 6.9 for Trading Interval t , corrected for Loss Factor adjustments so as to be a sent out quantity in accordance with clause 4.26.2A; plus
 - iv. double the total MWh quantity to be provided as Ancillary Services as specified by the IMO in accordance with clause 6.3A.2(e)(i) for the Electricity Generation Corporation corrected for Loss Factor adjustments so as to be a sent out quantity in accordance with clause 4.26.2A; plus

v. the greater of zero and $(BSFO(p,d,t) - RTFO(p,d,t))$.

The previous term is explained in the context of (b) above.

$BSFO(p,d,t)$ is the total MW quantity of Forced Outage associated with Market Participant p before the STEM Auction for Trading Interval t of Trading Day d , where this is the sum over all the Market Participant's Registered Facilities of the lesser of the Reserve Capacity Obligation Quantity of the Facility for Trading Interval t and the MW Forced Outage of the Facility for Trading Interval t as provided to the IMO by System Management in accordance with clause 7.3;

$RTFO(p,d,t)$ is the total MW quantity of Forced Outage associated with Market Participant p in real-time for Trading Interval t of Trading Day d , where this is the sum over all the Market Participant's Registered Facilities of the lesser of the Reserve Capacity Obligation Quantity of the Facility for Trading Interval t and the MW Forced Outage of the Facility for Trading Interval t as provided to the IMO by System Management in accordance with clause 7.13.1(e);

$DSQ(p,d,t)$ is a MW quantity calculated by doubling the MWh value of the sum over all of the Facilities registered by Market Participant p of each Facility's Dispatch Schedule for Trading Interval t of Trading Day d ;

$TOL(p,d,t)$ is a MW quantity calculated by doubling the MWh value of the sum over all of the Scheduled Generators and Dispatchable Loads registered by Market Participant p of each Facility's Facility Dispatch Tolerance in Trading Interval t of Trading Day d ;

In the following clause MSQ is based on the greater of zero and the metered schedule because if a generator has embedded load and is not running then the metered schedule could be less than zero. E.g. a 100 MW generator with 40 MW of embedded load might only have 60 MW of capacity credits. If it is dispatched to a level of 60 MW but its metered schedule is negative 40 MW, then its reserve capacity shortfall should be $60 - \text{Max}(0, -40) = 60$ MW. Without this adjustment the generator would have to pay a refund for capacity it is not obliged to provide.

$MSQ(p,d,t)$ is a MW quantity calculated by doubling the MWh value of the sum over all of the Facilities registered by Market Participant p of the greater of zero and each Facility's Metered Schedule for Trading Interval t of Trading Day d corrected for Loss Factor adjustments applicable to that Facility so as to be a sent out quantity.

The equation $SF(p,d,t) = \text{Max}(RTFO(p,d,t), RCOQ(p,d,t) - A(p,d,t)) + \text{Max}(0, B(p,d,t) - C(p,d,t))$ has two components. The component $\text{Max}(RTFO(p,d,t), RCOQ(p,d,t) - A(p,d,t))$ quantifies the amount of capacity that should have been made available but was not (whether due to capacity not being offered or Forced Outages preventing the capacity being offered), while $\text{Max}(0, \text{Min}(B(p,d,t) - C(p,d,t)))$ quantifies the amount by which metered

Chapter 4

schedules fall short of scheduled quantities. The following table illustrates the calculations, ignoring Facility Dispatch Tolerances.

Trading Interval	1	2	3	4	5	6	7	8	9	10
Reserve Capacity Obligation Quantity (RCOQ)	0	10	10	10	10	10	10	10	10	10
Energy offered in balancing/RTM (CAPA)	10	10	8	10	8	8	9.5	10	4	12
Total real time Forced Outage (RTFO)	0	0	0	5	0	2.5	0	2	0	0
Dispatch Schedule (DSQ)	8	7	7	4	8	8	8	8	4	12
Metered Schedule (MSQ)	1	10	7	4	8	7	6	8	0	2
A = Min(RCOQ, CAPA)	0	10	8	10	8	8	9.5	10	4	10
B = Min(RCOQ-RTFO, DSQ)	0	7	7	4	8	7.5	8	8	4	10
C = Min(DSQ, MSQ)	1	7	7	4	8	7	6	8	0	2
RCOQ - A	0	0	2	0	2	2	0.5	0	6	0
Max(RTFO, RCOQ - A)	0	0	2	5	2	2.5	0.5	2	6	0
Max(0,B-C)	0	0	0	0	0	0.5	2	0	4	8
SF = Max(RTFO, RCOQ - A) + Max(0,B-C)	0	0	2	5	2	3	2.5	2	10	8

Note that if the Electricity Generation Corporation generators do not have revenue quality meters then this may need to be applied to an estimate of the Electricity Generation Corporation's total generation. For this reason, penalties are applied based on the overall performance of each Market Participant, rather than on a facility by facility basis.

4.26.2A. All values in clause 4.26.2 which are required to be corrected for Loss Factor adjustments so as to be a sent out quantity are to be adjusted based on an assumed Loss Factor of 1.

4.26.2B. The IMO is to set the factor described in the definition of RCOQ(p,d,t) in clause 4.26.2 to equal one in all situations except for Scheduled Generators, Non-Scheduled Generators and Dispatchable Loads with Loss Factors less than one in which event the factor must equal the facilities Loss Factor.

A Loss Factor of 1 is assumed in clause 4.26.2A for simplicity. Almost all generators have Loss Factors greater than 1, meaning that if 1 MW is offered at the site of a facility then the Loss Factor adjusted quantities at the reference Node will exceed 1, making it easier for these generators to cover their Reserve Capacity Obligation Quantities. Currently there are a very small number of generators (e.g. 1 or 2) with Loss Factors fractionally less than 1. To the extent that such generators are not in a portfolio of generators (with an average loss factor greater than 1) then assuming a Loss Factor of 1 could unfairly expose such generators to Reserve Capacity Refunds. To avoid this, clause 4.26.2B specifies a weighting to apply in clause 4.26.2 to the Reserve Capacity Obligation Quantity of the Facility so as to ensure that it is not disadvantaged by its Loss Factor.

Thus a facility with a Reserve Capacity Obligation Quantity of 1 MW and a Loss Factor of 1.2 would have a factor of 1, so if it offered this energy into the STEM it would have A = 1.2 and RCOQ of 1, which would not expose it to a shortfall.

If it has a Loss Factor of 0.98 then it would offer 1 MW at the site of the Facility, so the energy it offers into the STEM would be Loss Factor adjusted by 0.98 to give A = 0.98. But because its Loss Factor is less than 1, the Reserve Capacity Obligation Quantity would also

Chapter 4

be adjusted to be 0.98, preventing the Market Participant from being exposed to a shortfall of 0.02.

4.26.3. For each Market Participant holding Capacity Credits, the IMO must determine the amount of the refund (“**Capacity Cost Refund**”) to be applied for Trading Month *m* in respect of a Capacity Shortfall as defined in clauses 4.26.2 during that Trading Month. The Capacity Cost Refund is the lesser of:

- (a) the Maximum Refund determined in accordance with the Refund Table, less all Capacity Cost Refunds applicable to the Market Participant in previous Trading Months falling in the same Capacity Year as Trading Month *m*; and
- (b) the Maximum Seasonal Rate determined in accordance with the Refund Table, multiplied by the average Trading Interval Capacity Shortfall calculated over the Season within which Trading Month *m* falls, less the sum of the Capacity Cost Refunds applicable to the Market Participant in previous Trading Months which fall in the same Season; and
- (c) the sum of the relevant amounts for Trading Month *m*, where a relevant amount is calculated for each Trading Day *d* in Trading Month *m* and is equal to the lesser of:
 - i. the Maximum Daily Rate determined in accordance with the Refund Table for Trading Day *d* multiplied by the sum over all Trading Intervals *t* in Trading Day *d* of the Capacity Shortfall in Trading Interval *t*; and
 - ii. the sum over all Trading Intervals *t* in Trading Day *d* of the product of:
 1. the Off-Peak Trading Interval Rate or Peak Trading Interval Rate determined in accordance with the Refund Table applicable to Trading Interval *t*; and
 2. the Capacity Shortfall in Trading Interval *t*.

4.26.4. The IMO must apply any revenue generated from the application of clause 4.26.3 to Market Customers in accordance with clause 4.28.4.

4.26.5. To support the calculation of the value of RCOQ(*p,d,t*) required by clause 4.26.2:

- (a) the IMO must record the following temperature data for generation systems (other than Intermittent Generators) in respect of which Market Participants hold Capacity Credits and which, in accordance with clause 4.10.1(e)(iv), indicated a valid method for measuring ambient temperature:
 - i. the publicly available maximum daily temperature associated with a Facility for which temperature is defined in accordance with clause 4.10.1(e)(iv)(1); and
 - ii. temperatures provided by System Management for Facilities for which temperature is defined in accordance with clause 4.10.1(e)(iv)(2).

- (b) System Management must provide the temperatures described in clause 4.26.5(a)(ii) for a Trading Month to the IMO not later than two Business Days prior to the relevant Non-STEM Settlement Statement Date.

4.27. Reserve Capacity Performance Monitoring

This section defines performance-monitoring criteria. The performance monitoring of existing facilities relates to the overall performance of the market with respect to Planned Outages. The rules define a trigger that if exceeded, leads to tighter standards of performance for facilities that are taking an unreasonable amount of Planned Outages. The idea is that facilities that require a large amount of Planned Outage time are not affected if the system as a whole is performing satisfactorily. But if the system as a whole is failing to have adequate capacity available then the increased performance requirements indicates a need to spend more on existing plant to keep them available, or to replace them with newer plant.

With regard to facilities under development, the monitoring is restricted to ensuring that the facility will be available when expected, and if not, to forecast when it will be ready and, if required, to take mitigating actions.

If the Market as a whole performs poorly with respect to Reserve Capacity then those who perform poorly will be required to state their expected Planned Outages for the next year, and will need to have this figure approved by the IMO. Note though, that this has nothing at all to do with scheduling outages with System Management, it is simply an indication of how much Planned Outage that facility expects to take. If the facility takes more Planned Outages then those outages will be treated like Forced Outages for the purpose of settlement of Reserve Capacity. Again, this does not change their official status as Planned Outages. For facilities that have yet to commence operation, no payments will be made until the commencement of operation.

Clause 7.3 and 7.13 have rules requiring System Management to provide outage data to the IMO.

4.27.1. The IMO must monitor the total availability of capacity in the SWIS on a daily basis. The total available capacity should equal:

- (a) the total Capacity Credits held by Market Participants on that day; less
- (b) the maximum amount of capacity unavailable at any time due to Planned Outages.

4.27.2. By the fifth Business Day of each month, the IMO must assess the number of days in the preceding 12 calendar months where the total available capacity in the SWIS dropped below 80% (during the Hot Season), and 70% (in either the Shoulder Demand or Cool Season), of the total Capacity Credits held by Market Participants for more than six hours on the day.

Chapter 4

Clause 4.27.2 relates to both forced and planned outages.

4.27.3. If the number of days determined in accordance with clause 4.27.2 exceeds 40, then the IMO must require reports to be filed by those Market Participants holding Capacity Credits for each Facility which:

- (a) has been unavailable due to Planned Outages for more than 1000 hours during the preceding 12 calendar months; and
- (b) has not been included in such a report during the preceding 12 calendar months.

4.27.4. The reports described in clause 4.27.3 must include:

- (a) explanations of all Planned Outages taken by the Facility in the preceding 12 calendar months;
- (b) a statement of the expected maximum number of days of Planned Outages to be taken by the Facility in each of the next 24 months commencing from the month in which the report is requested, including adequate explanation to make clear the reason for each Planned Outage; and
- (c) measures proposed by the Market Participant to increase the availability of the Facility.

Note that we have no interest in forced outages. The purpose of these reports is to allow an amount of planned outages to be defined beyond which the outage will be treated like a forced outage with respect to Reserve Capacity settlement if (and only if) the market as a whole is performing badly in providing capacity.

4.27.5. A Market Participant must provide a report described in clause 4.27.3, to the IMO in a format specified in the Reserve Capacity Procedure within 20 Business Days of being requested to do so.

4.27.6. The IMO must consult with System Management on the implications of a report.

4.27.7. If the IMO considers the number of days reported in accordance with clause 4.27.4(b) to be unjustified based on good industry practice, it may, at its sole discretion limit the number of days on which Planned Outages are to be taken by the Facility in each of the next 24 months for the purposes of clause 4.27.8 and 4.27.9 and must notify the Market Participant who filed the report described in clause 4.27.3 of the limit.

The limit is NOT on the number of days that planned outages can occur, but on the number of days that planned outages can be taken while being exempt for Capacity Credit Refund payments (and only when clause 4.27.9 applies) This section is not intended to restrict the ability of a market participant to request a planned outage.

Chapter 4

- 4.27.8. If the IMO limits the number of days in accordance with clause 4.27.7, then the modified value is to supersede the corresponding value specified in the report described in clause 4.27.4.
- 4.27.9. If the number of days determined in accordance with clause 4.27.2 exceeds 80, then the IMO must:
- (a) notify all Market Participants that this has occurred; and
 - (b) during the 12 months commencing from the first Trading Day of the following month, cease to adjust Reserve Capacity Obligation Quantities under clause 4.12.6(b) in response to Planned Outages for Facilities:
 - i. referred to in clause 4.27.3; and
 - ii. for which the number of days of Planned Outage during that 12 month period has exceeded the total number of days of Planned Outage predicted for that 12 month period in accordance with clause 4.27.4(b), as modified by clause 4.27.8.

While the next two clauses relate to facilities that are yet to enter service, they are included in this performance monitoring section as the IMO has to be able to monitor their performance in achieving the schedule in clause 4.10.1(c)(iii). Note that the disincentive for being late with a facility is that the market participant operating the facility will have to refund Reserve Capacity payments in accordance with clause 4.26 until the Facility is operating and if the facility is too late, it can lose its Reserve Capacity Security Deposit. Note that the capacity credits associated with a facility that is late in entering service are still available to cover retailer requirements for capacity credits.

- 4.27.10. Market Participants holding Capacity Credits for Facilities that are yet to commence operation must file a report on progress with the IMO at least once every three months between the date the Capacity Credit is confirmed under clause 4.20 and the date that Facility commences operation.
- 4.27.11. The report described in clause 4.27.10 must include the current revised estimates of each date to which clause 4.10.1(c)(iii) refers.
- 4.27.12. The IMO must document the procedure to be followed in performing Reserve Capacity monitoring in the Reserve Capacity Procedure, and the IMO, System Management, and Market Participants must follow that documented Market Procedure in the performance of Reserve Capacity monitoring.

Funding Reserve Capacity Purchased by the IMO

4.28. Funding Reserve Capacity Purchased by the IMO

4.28.1. The IMO must separate the total costs of Capacity Credits acquired by it for a Trading Month, including Capacity Credits covered by Special Price Arrangements, into the following two sets:

- (a) the cost of acquiring the Capacity Credits required to ensure that the Reserve Capacity Requirement applicable to that Trading Month is just covered after allowing for Capacity Credits traded bilaterally in that Trading Month; and

Suppose the IMO has procured 60 MW of Reserve Capacity when the requirement was only 45 MW --- it had to procure 60 MW because it has to take whole plants. Now suppose that it covered the requirement with 3 20 MW generators, where one was procured at the auction price of \$1, one was scheduled out of merit order at \$2 and holds a short term special price arrangement, and one was automatically scheduled as it holds a long term special price arrangement valued at \$3. The Reserve Capacity Requirement is 45 MW, so (a) relates to the cost of $\$3 * 20 + \$2 * 20 + \$1 * 5$. The residual, to be covered in the following clause, is $\$1 * 15$. The point being that we want those without capacity credits to pay for the highest cost part of the Capacity Credits procured by the IMO, where as the costs in (b), which are shared amongst all retailers, will be the lowest cost part.

- (b) the cost of acquiring other Capacity Credits not allocated to the set referred to in paragraph (a);

determined on the basis that the Capacity Credits acquired by the IMO are allocated to the set referred to in paragraph (a) in order of decreasing cost per Capacity Credit until the capacity requirements referred to in paragraph (a) are met, with the remaining Capacity Credits acquired by the IMO being allocated to the set in paragraph (b).

The costs identified in (a) will be allocated to those Market Customers not holding Capacity Credits while the costs in (b) will be shared across all Market Customers. To minimise the costs that must be shared, and given that different Special Price Arrangements will have different costs, the costs in (a) are defined to be the highest cost mix of Capacity Credits required to just cover the Reserve Capacity Requirement

4.28.2. For these purposes:

Note the wording "For these purposes" does not just relate to this section 4.28, as it is also referenced from the Refund Table.

- (a) IMO is taken to have acquired a Capacity Credit held by a Market Participant in respect of a Trading Month if that Capacity Credit has not been allocated

by that Market Participant to another Market Participant for settlement purposes under clauses 9.4 and 9.5;

- (b) the cost of a Capacity Credit acquired by the IMO which is covered by a Long Term Special Price Arrangement is the Special Reserve Capacity Price determined in accordance with clause 4.22.3;
- (c) the cost of a Capacity Credit acquired by the IMO which is covered by a Short Term Special Price Arrangement is the Special Reserve Capacity Price determined in accordance with clause 4.21.1(b); and
- (d) the cost of each other Capacity Credit acquired by the IMO is the Monthly Reserve Capacity Price determined in accordance with clause 4.29.1.

4.28.3. For each Trading Month, the IMO must calculate the Targeted Reserve Capacity Cost being the sum of:

- (a) the cost defined under clause 4.28.1(a); and
- (b) the net payments to be made by the IMO under Supplementary Capacity Contracts less any amount drawn under a Reserve Capacity Security by the IMO and distributed in accordance with clause 4.13.11(a),

and the IMO must allocate this total cost to Market Customers in proportion to each Market Customer's Individual Reserve Capacity Requirement less the quantity of Capacity Credits allocated to that Market Customer in accordance with clauses 9.4 and 9.5.

4.28.4. For each Trading Month, the IMO must calculate a Shared Reserve Capacity Cost being the sum of:

- (a) the cost defined under clause 4.28.1(b); less
- (b) the Capacity Cost Refunds for that Trading Month; less
- (bA) the Intermittent Load Refunds for that Trading Month; less
- (c) any amount drawn under a Reserve Capacity Security by the IMO and distributed in accordance with clause 4.13.11(b)

and the IMO must allocate this total cost to Market Customers in proportion to each Market Customer's Individual Reserve Capacity Requirement.

4.28.5. The Shared Reserve Capacity Cost may have a negative value if there is no over-supply of capacity.

4.28.6. For the first Reserve Capacity Cycle the IMO must within the time limits required by clause 4.1.22 publish the date and time from which the Initial Reserve Capacity Requirement will apply.

Chapter 4

4.28.7. The IMO must determine and publish an initial Individual Reserve Capacity Requirement for each Market Customer by the date and time specified in clause 4.1.24 where this Individual Reserve Capacity Requirement:

- (a) is determined using the methodology described in Appendix 5 and clause 4.28.7A; and
- (b) applies from the date and time specified in clause 4.1.25.

4.28.7A. The IMO must set the Intermittent Load Reserve Capacity Requirement to apply for the first Trading Month of the Capacity Year for each Intermittent Load for which a Market Customer provided the IMO with the information specified in clause 4.28.8(c) in accordance with Appendix 4A.

4.28.8. To assist the IMO in determining Individual Reserve Capacity Requirements in accordance with clause 4.28.7, Market Customers must, by the date and time specified in clauses 4.1.23, provide to the IMO:

- (a) a list of interval meters associated with that Market Customer that the Market Customer wants the IMO to treat as Non-Temperature Dependent Loads;
- (b) details of any Demand Side Management measures that the Market Customer has implemented since the previous Hot Season, including the expected MW reduction in peak consumption resulting from those measures; and
- (c) nominations of capacity requirements for Intermittent Loads, expressed in MW, where the nominated quantity cannot exceed the greater of:
 - i. the maximum allowed level of Intermittent Load specified in Standing Data for that Intermittent Load at the time of providing the data; and
 - ii. the maximum Contractual Maximum Demand expected to be associated with that Intermittent Load during the Capacity Year to which the nomination relates. The Market Customer must provide evidence to the IMO of this Contractual Maximum Demand level unless the IMO has previously been provided with that evidence.

4.28.8A. Any Intermittent Load that was not registered by the date and time specified in clause 4.1.23 must provide the IMO with the information described in clause 4.28.8(c) no later than 5 Business Days prior to the date and time specified in clause 4.1.28(b) where that date and time relates to the Trading Month in which the Intermittent Load will first commence operation.

The timing is dictated by the requirement for the IMO to update Individual Reserve Capacity Requirements.

4.28.8B. The IMO must accept a nomination for capacity from a Market Customer if that nomination is made in accordance with clauses 4.28.8 or 4.28.8A provided that

Chapter 4

the IMO is satisfied of the accuracy of the data and evidence provided in accordance with clause 4.28.8(c)(ii).

4.28.9. The IMO must only accept the load measured by an interval meter in the list provided in accordance with clause 4.28.8(a) as a Non-Temperature Dependent Load if that load:

- (a) had a peak consumption during the previous Hot Season in excess of 1 MWh; and
- (b) did not deviate downwards from the peak consumption in paragraph (a) by more than 10% for more than 10% of the time during the Hot Season except during Trading Intervals where:
 - i. the consumption was 0 MWh; or
 - ii. consumption was reduced at the request of System Management; or
 - iii. evidence is provided by the Market Customer that the source of the consumption was operating at below capacity due to maintenance or a Saturday, Sunday or a public holiday throughout Western Australia.

4.28.10. The IMO must only take into account a MW reduction in peak consumption resulting from Demand Side Management measures specified in accordance with clause 4.28.8(b) in applying the methodology of Appendix 5 to the extent that the IMO is satisfied that the peak consumption associated with the applicable Market Participant would have been lowered by that number of MWs had those Demand Side Management measures been in place during the preceding Hot Season.

4.28.11. The IMO must determine and publish an updated Individual Reserve Capacity Requirement for each Market Customer by the date and time specified in clause 4.1.28(b) where this Individual Reserve Capacity Requirement:

- (a) is determined using the methodology described in Appendix 5 and based on Individual Reserve Capacity Requirements for Intermittent Loads determined for each Trading Month in accordance with Appendix 4A; and
- (b) applies from the commencement of the first Trading Month commencing after the date of publication of the updated Individual Reserve Capacity Requirement.

4.28.12. The IMO must document the process to be followed in initially calculating, and subsequently revising, Individual Reserve Capacity Requirements in the Reserve Capacity Procedure, and the IMO and Market Customers must follow that documented Market Procedure.

Intermittent Load Refunds

4.28A. Intermittent Load Refunds

Intermittent Loads are usually supplied by their own generators. For this reason the generator does not need to go through the normal reserve capacity process while the load does not need to fund reserve capacity, except for its contribution to the system reserve margin.

If the Intermittent Loads generator fails for any reason other than an approved outage then it is necessary for the Intermittent Load to pay refunds similar to Reserve Capacity Refunds. Were this not to be the case then generators supplying Intermittent Loads would face a lower cost for outages than generators with Reserve Capacity obligations. This is implemented by applying a refund based on the amount of Intermittent Load that occurs during each Trading Interval for which the generator is not on an approved outage.

4.28A.1 The IMO must determine for each Intermittent Load registered to Market Participant p the amount of the refund (“Intermittent Load Refund”) to be applied for each Trading Month m in respect of that Intermittent Load using the methodology for determining Capacity Cost Refunds as described in clause 4.26.3 assuming:

- (a) that the applicable value of Y in the Refund Table described in clause 4.26.1 is that which applies for Scheduled Generators;
- (b) that the Maximum Refund defined in the Refund Table described in clause 4.26.1 is, for a given Intermittent Load and Trading Month, set to equal the value of Reserve Capacity payments that would have been made to the generation system described in clause 2.30B.2(a) for the 12 Trading Months commencing at the start of the Trading Day of the previous 1 October assuming that the IMO had procured Reserve Capacity from it for each of those months equal to the quantity nominated for that Intermittent Load by its Market Customer in accordance with clause 4.28.8(c) at the prevailing Monthly Reserve Capacity Price.

If an Intermittent Load is registered and commences operation during a Capacity Year then this maximum value will not be reduced. However, the seasonal caps will tend to limit the refunds anyway.

- (c) that the Capacity Shortfall for Trading Interval t of Trading Day d and Trading Month m is the greater of zero and:
 - i. double the MWh Intermittent Load metered during that Trading Interval, less;
 - ii. if the generating system described in clause 2.30B.2(a) is undergoing a Planned Outage or a Consequential Outage, the quantity nominated for that Intermittent Load by its Market Customer in accordance with clause 4.28.8(c); less

Chapter 4

- iii. 3% of the quantity nominated for that Intermittent Load by its Market Customer in accordance with clause 4.28.8(c); less
- iv. for Trading Intervals where the temperature data described in clause 4.28A.2 shows a temperature in excess of 41°C and the generating system described in clause 2.30B.2(a) is not undergoing a Planned Outage, Forced Outage or a Consequential Outage, the capacity reduction, if any, specified in accordance with clause 2.30B.3(b)(i).

Clause (i) uses positive Intermittent Load metered values as the basis of applying refunds. These are doubled to convert them to equivalent MW figures. If the generation system serving that load is not on an outage then the amount in clause (i) should be zero, and any excess will be subject to the refund. However, if the generation system is on an approved outage then clause (ii) subtracts the nominated capacity from the number in clause (i), meaning that refunds will only apply if the Market Customer consumes more than it nominated.

Clause (iii) applies a tolerance that applies in all situations.

Clause (iv) further reduces exposure to refunds in situations where the generation system is operational but the ambient temperature is very high. This parallels reductions contemplated in Chapter 4 for generators providing Reserve Capacity.

4.28A.2. To support the implementation of clause 4.28A.1(c)(iv)

- (a) the IMO must record the following temperature data for generation systems in respect of which this clause 4.28A applies and for which, in accordance with clause 2.30B.3(b)(ii), a valid method for measuring ambient temperature was indicated:
 - i. the publicly available maximum daily temperature associated with those generating systems for which temperature is defined in accordance with clause 2.30B.3(b)(ii)(1); and
 - ii. temperatures provided by System Management for those generating systems for which temperature is defined in accordance with clause 2.30B.3(b)(ii)(2).
- (b) System Management must provide the temperatures described in clause 4.28A.2(a)(ii) for a Trading Month to the IMO not later than two Business Days prior to the relevant Non-STEM Settlement Statement Date.

4.28A.3 The IMO must document the procedure the IMO must follow in calculating Intermittent Load Refunds in the Reserve Capacity Procedure, and the IMO must follow that documented Market Procedure when calculating Intermittent Load Refunds.

Treatment of New Small Generators

4.28B. Treatment of New Small Generators

A Non-Scheduled Generator with a nameplate capacity of less than 1 MW may gain Capacity Credits through the process described in this clause 4.28B for a period of up to a year starting 1 October and then only until the first time it could (or has) acquired Capacity Credits through the normal processes.

4.28B.1 This section 4.28B is applicable to Registered Facilities to which the following conditions apply:

- (a) the Facility is a Non-Scheduled Generator and has commenced operation;
- (b) the Facility has a nameplate capacity not exceeding 1 MW;
- (c) the Facility has not previously held Capacity Credits for past Reserve Capacity Cycles and does not hold Capacity Credits for the Reserve Capacity Cycle for which Capacity Credits are sought; and
- (d) there has been no opportunity for the Market Participant to which the Facility is registered to apply for certification of Reserve Capacity for the Facility for the Reserve Capacity Cycle for which Capacity Credits are sought in accordance with clause 4.9 since the date upon which the Facility became a Registered Facility;

4.28B.2 A Market Participant to which a Facility is registered that this clause 4.28B relates to may apply to the IMO for Capacity Credits for that Facility at any time between the date upon which the Facility became a Registered Facility and the earliest date upon which either:

- (a) Reserve Capacity Obligations could apply to the Facility where such Reserve Capacity Obligations relate to Capacity Credits secured in accordance with clause 4.20 at the earliest possible opportunity following the registration of the Facility; or
- (b) Reserve Capacity Obligations actually apply to the Facility due to Capacity Credits secured in accordance with clause 4.20 prior to the registration of the Facility.

4.28B.3 An application made under clause 4.28B.2 must include all the information required by clause 4.10 for a Non-Scheduled Generator, with the modification that the decommissioning date required by clause 4.10.1(d) is only required if the Facility will be decommissioned prior to the end date defined in clause 4.28B.6.

4.28B.4 The IMO must process an application made in accordance with clause 4.28B.2 so as to determine the Certified Reserve Capacity, Capacity Credits and Reserve Capacity Obligations to associate with the Facility:

Chapter 4

- (a) The IMO must set Certified Reserve Capacity for the Facility to that amount it would normally grant the Facility if processing an application for Certified Reserve Capacity in accordance with clause 4.11;

These rules only relate to the issuing of Capacity Credits for a Capacity Year after the normal bilateral trade/auction process is complete and as such the only reason for defining Certified Reserve Capacity is to provide a basis for reducing Reserve Capacity Obligation Quantities in accordance with clause 4.12.6 (if required).

- (b) The IMO must set the Capacity Credits for the facility to equal the Certified Reserve Capacity of the Facility; and
- (c) The IMO must set the Reserve Capacity Obligations, including the initial Reserve Capacity Obligation Quantity, for the Facility in accordance with clause 4.12 as if set as part of an application for Certified Reserve Capacity made in accordance with clause 4.11.

4.28B.5 The IMO must process an application made in accordance with clause 4.28B.2 within 10 Business Days of receipt of the application.

4.28B.6 If the IMO approves the granting of Capacity Credits to the Facility then the Capacity Credits and the Reserve Capacity Obligations associated with that Facility are to apply from the commencement of the Trading Day commencing on the start date until the end of the Trading Day ending on the end date where:

- (a) the start date is the next occurrence of the date 1 October after the date on which the IMO grants approval, or if the IMO grants approval prior to Energy Market Commencement then the date of Energy Market Commencement; and
- (b) the end date is the earlier of:
- i. the first date that Reserve Capacity Obligations could apply to the Facility where such Reserve Capacity Obligations relate to Capacity Credits secured in accordance with clause 4.20 at the earliest possible opportunity following the registration of the Facility;
 - ii. the first date that Reserve Capacity Obligations actually apply to the Facility due to Capacity Credits secured in accordance with clause 4.20 prior to the registration of the Facility;
 - iii. the first instance of the date 1 October after the start date; and
 - iv. the decommissioning date of the Facility;

If the IMO approves the capacity credits prior to Energy Market Commencement, then if the market commences on 1 July 2006 the end date would be 1 October 2006.

Chapter 4

4.28B.7 A Market Participant may re-apply to the IMO for Capacity Credits in accordance with this clause 4.28B if Capacity Credits issued in accordance with this clause 4.28B have, or are due to, expire in accordance with clause 4.28B.6(b)(iii).

4.28B.8 Any Capacity Credit issued by the IMO under this clause 4.28B

- (a) is, for the purpose of settlement, to be treated as if it were traded bilaterally in accordance with clause 4.14; and
- (b) is not eligible to have a Long Term Special Price Arrangement or Short Term Special Price Arrangement associated with it.

4.28B.9. The IMO must document the process for applying for and approving Capacity Credits in accordance with this clause 4.28B in the Reserve Capacity Procedure, and the IMO and Market Participants must follow that documented Market Procedure.

Settlement Data

4.29. Settlement Data

4.29.1. The Monthly Reserve Capacity Price to apply during the period specified in clause 4.1.29 is to equal:

- (a) if a Reserve Capacity Auction was run for the Reserve Capacity Cycle, the Reserve Capacity Price for the Reserve Capacity Cycle divided by 12; or
- (b) if no Reserve Capacity Auction was run for the Reserve Capacity Cycle, 85% of the Maximum Reserve Capacity Price for the Reserve Capacity Cycle divided by 12.

Clause (b) is required because parties who cease to be covered by a bilateral trade of Capacity Credits will be settled at the Monthly Reserve Capacity Price. If no auction was held then we must use a default price. A default price equal to 85% of the maximum allowed price was judged to be high enough without being too high, and could be reviewed as experience is gained over time.

Consideration is being given to a proposal to change the 85% factor described here and in the context of Reserve Capacity Refunds be modified in the future so that the percentage drops as a function of the degree to which the market has significant surplus capacity. Thus, based on the outcome of the bilateral trade/auction process described in Chapter 4, the more Capacity Credits the market has which is significantly in excess of the Reserve Capacity Requirement, the lower the percentage would be.

4.29.2. The Monthly Special Reserve Capacity Price to apply during a Trading Month for each Special Price Arrangement associated with a Facility is to equal the Special Reserve Capacity Price for that Special Price Arrangement and Reserve Capacity Cycle divided by 12.

Chapter 4

4.29.3. The IMO must prepare and provide the following information to the Settlement Systems in time for settlement of Trading Month m:

- (a) the Monthly Reserve Capacity Price applying during that Trading Month;
- (b) the Targeted Reserve Capacity Cost for that Trading Month as defined in clause 4.28.3;
- (c) the Shared Reserve Capacity Cost for that Trading Month as defined in clause 4.28.4;
- (d) subject to clause 4.29.4, for each Market Participant p and for Trading Month m:
 - i. the quantity of Capacity Credits acquired by the IMO to which no Special Price Arrangement applies, including Capacity Credits from Facilities subject to Network Control Service Contracts to which clause 4.20.1(d)(iii) does not apply;
 - ii. the quantity of Capacity Credits acquired by the IMO covered by a Special Price Arrangement;
 - iii. the total quantity of Capacity Credits covered by Special Price Arrangements;
 - iv. the quantity of Capacity Credits traded bilaterally that are not covered by Special Price Arrangements, including Capacity Credits from Facilities subject to Network Control Service Contracts to which clause 4.20.1(d)(iii) does apply;

The total capacity credits issued should equal (i) + (iii) + (iv). The total number of Capacity Credits traded bilaterally that hold a Special Price Arrangement equals (iii) –(ii).

- v. the Individual Reserve Capacity Requirement for each Market Customer for that Trading Month; and
- vi. the total Capacity Cost Refund to be paid by the Market Participant to the IMO;
- (dA) for each Market Participant, the Intermittent Load Refund to be paid by the Market Participant to the IMO for each of its Intermittent Loads;
- (e) for each Supplementary Capacity Contract:
 - i. the net payment to be made by the IMO under that contract for the Trading Month;
 - ii. to whom the payment is to be made; and

The payment may be made to someone who is not a Market Participant. The changes reflect that the contracts will be negotiated, so we cannot be certain that the pricing structure we prescribe for the standard contract will be reflected in the final contract.

Chapter 4

- iii. how the payment is to be made if the party identified in (ii) is not a Market Participant.

4.29.4. If a Capacity Credit is terminated for any reason during a Trading Month then the IMO must adjust the quantities specified in clause 4.29.3(d) to reflect the proportion of the Trading Month for which the Capacity Credit existed.

5 Network Control Service Procurement

While the main provisions of Network Control Service procurement are set out in this chapter, it is recognised that some of the details may require further development.

A Network Operator covered by the Access Code must inform the IMO of a “major augmentation” if there is an opportunity for generation or Demand Side Management at a particular location to compete with the transmission or distribution upgrade. The IMO will run a tender. If the generation or DSM option is cheaper, then the IMO would enter into a long term Network Control Service Contract with the generator/DSM provider. If the network option wins the tender, then no Network Control Service Contract is needed, the Network Operator would simply go ahead with the network upgrade and the ERA would take account of the tender when looking at the cost recovery. Note also that the Network Operator is not forced to submit a tender if it believes it would not be competitive with the other options.

The contract would provide monthly revenue to the generator/DSM provider – if the IMO’s calculation of their revenue from the capacity markets is less than the monthly level then the IMO will pay the difference to the generator/DSM provider and bill the Network Operator for this amount. The contract will contain terms for calling on the facility, and the IMO will give the operational control of calling on the facility to System Management.

If a generation or DSM option wins the tender, then the participant must also apply to the IMO to assess the facility for Certified Reserve Capacity (although if the facility faces operational constraints that make it unsuitable for supplying Reserve Capacity the IMO will not grant it Certified Reserve Capacity). Where the facility is granted Certified Reserve Capacity it is treated as a price taker in the Reserve Capacity Auction. In the energy market note that the participant’s standing data price that they will receive if they are issued a Dispatch Instruction is specified in the Network Control Services Contract

Network Control Service Tender Process and Timelines

5.1. Definitions and Obligations

5.1.1. A Network Control Service is any service specified according to clause 5.2.1.

5.1.2. A Network Control Service Contract is a contract between the IMO and a Market Participant for the Market Participant to provide a Network Control Service.

5.1.3. The IMO must not enter into a Network Control Service Contract except:

- (a) following a tender process under clause 5.4; or
- (b) in the case of a Network Control Service Contract to apply from Energy Market Commencement, with the approval of the Minister.

Chapter 5

5.1.4. The IMO must seek to carry out the expression of interest, certification and tender processes in this Chapter 5 in a way that minimises its costs of doing so.

5.2. Network Control Service Procurement Requirements

5.2.1. Where required by the Access Code to submit a major augmentation, as defined in the Access Code, to the tender process set out in the Market Rules, a Network Operator must notify the IMO of the opportunity for network support generation or Demand Side Management to compete with a transmission or distribution upgrade. The notification must include:

- (a) a specification of the services that would be required from the facility, including:
 - i. the maximum active and reactive power quantities required, specified in MW and MVAR;
 - ii. the estimated number of hours per year that the services would be required; and
 - iii. the required period of notice to call upon the services;

This would include MW, MVAR required, possibly with profiles over time.

- (b) the location at which the facility would need to connect to the relevant network;
- (c) the Network Operator's estimate of the costs involved in connecting a generation facility that could provide the services specified in (a) from the location specified in (b);
- (d) the time by which the facility is required to be in service; and
- (e) the Network Operator's estimate of the cost of an augmentation to the Network that would provide the services.

This initial estimate is used by the IMO when making its EOI assessment.

5.2.2. The minimum period over which the Network Control Service is required is ten years from the date specified clause 5.2.1(d). The IMO may extend the length of the contracted period.

There may need to be some reconsideration of the term over which the options are compared, given the possibly different economic lifetimes of transmission, generation and DSM options.

5.2.3. The IMO must call for expressions of interest from potential service providers to identify whether any other person could provide the required Network Control Service.

Chapter 5

Note that prospective generators/DSM providers must become Market Participants to participate in the tender process, but do not need to be registered for the expressions of interest stage.

The Network Operator does not need to participate in the EOI, since the notification contains the relevant information.

5.2.4. A person (“**potential service provider**”) may submit a written expression of interest to the IMO indicating that the potential service provider considers that it would be able to provide the Network Control Service. The expression of interest must contain:

- (a) the approximate quantity of the Network Control Service that the potential service provider would be able to supply;
- (b) whether the Network Control Service will be provided by a generation facility or Demand Side Management option ;
- (c) indicative arrangements for activating the Network Control Service;
- (d) the approximate cost of the Network Control Service; and
- (e) other material terms and conditions which the potential service provider proposes would apply to the provision of the Network Control Service.

5.2.5. An expression of interest is not binding on the potential service provider. A person is not required to have submitted an expression of interest to submit a tender response for any Network Control Service tender under clause 5.4.

5.2.6. Where, after considering the responses to the expression of interest, the IMO identifies that no person could provide the required Network Control Service for a cost that is less than 50% above the Network Operator’s estimate referred to in clause 5.2.1(e), then the IMO must:

- (a) notify that Network Operator that there are no other alternative providers; and
- (b) notify each person that submitted an expression of interest that no tender will be held.

5.2.7. Where the IMO identifies that a person other than the Network Operator described in clause 5.2.1 could provide the required Network Control Service, or a cost that is less than 50% above the Network Operator’s estimate referred to in clause 5.2.1(e), then the IMO must:

- (a) make the announcement in clause 5.4.1 within 10 Business Days of the closing date for expressions of interest; and
- (b) carry out the tender process described in clause 5.4.

5.3. Network Control Service Certification

The certification process is like a tender pre-qualification based on a technical assessment. The IMO might sub-contract this work.

5.3.1. A person must be registered as a Market Participant before applying for a Facility to be certified under clause 5.3.2.

5.3.2. A Market Participant wishing to submit a Network Control Service tender under clause 5.4 must apply to the IMO for certification that the IMO considers that the Facility can provide the relevant Network Control Service and of the level of that service that the IMO considers the Facility can reliably provide (“**Network Control Service Certification**”).

5.3.3. The Network Operator referred to in clause 5.2.1 does not need to apply to the IMO for certification.

The original Network Operator does not need to apply for certification, assuming that the IMO is clear enough from the notification given under clause 5.2.1 about what the Network Operator would provide to enable the IMO to compare it on an equal basis with the other options in the tender.

5.3.4. A Market Participant may apply for Network Control Service Certification in respect of a Facility that is not a Registered Facility.

But see clause 5.4.13 - the Market Participant must ensure that the facility is registered as a Registered Facility during the period for which Network Control Services are to be provided if it is awarded a Network Control Service Contract.

5.3.5. The Market Participant applying for Network Control Service Certification must provide to the IMO the information specified for this purpose in the Network Control Service Procedure.

5.3.6. The IMO may certify a Facility for a level of Network Control Service. The IMO must only certify a Facility for a level that the IMO is satisfied that the Facility can reliably provide.

5.3.7. A Network Control Service Certification must contain:

- (a) the Network Control Service tender for which the Network Control Service Certification was issued;
- (b) the Facility to which the Network Control Service Certification pertains;
- (c) the quantity of Network Control Service that may be reliably provided by the Facility, including any additional conditions or performance information; and
- (d) the notice period for calling upon the Network Control Service.

Chapter 5

5.3.8. Network Control Service Certifications expire after the IMO announces the results of the Network Control Service tender to which they relate.

The Network Control Service Contract itself will contain requirements for performance and testing during the period of the contract, so the certification is not needed.

5.3.9. The IMO must document the procedure it follows in processing applications for Network Control Service Certification in the Network Control Service Procedure, and the IMO, Market Participants and Network Operators must follow that documented Market Procedure when processing Network Control Service Certification applications.

5.4. Network Control Service tenders

5.4.1. Where it is required to carry out a tender process for Network Control Service, the IMO must publish details of the tender process and timelines, including:

- (a) the date by which Network Control Service Certification must be obtained for a tender to be submitted;
- (b) the date on which the invitation to tender will be published;
- (c) the last date on which the tenders may be submitted; and
- (d) the date on which the IMO will announce the results of the tender process.

5.4.2. By the date specified in clause 5.4.1(a), Market Participants wishing to submit a tender must have secured Network Control Service Certification for the relevant Facility in accordance with clause 5.4.

5.4.3. By the date specified in clause 5.4.1(b), the IMO must issue an invitation to tender for the acquisition of the relevant Network Control Service.

5.4.4. An invitation to tender for the acquisition of a Network Control Service must contain:

- (a) the quantity of the Network Control Service to be acquired under the invitation to tender including location and timing of the requirements, and any other limitations on the provision of the service, including minimum acceptable quantities;

It would be impractical for the IMO and System Management to manage very small contracted quantities.

- (b) the period over which the service is to be provided, determined in accordance with clause 5.2.2, including details of any extension options;
- (c) terms and conditions of the tender, including proposed terms and conditions for the Network Control Service Contracts to be entered into as a result of the tender process;
- (d) the required format and content of tender responses, including:

- i. the name and contact details of the tenderer;
- ii. the Facility which will provide the Network Control Service;
- iii. the quantity of the Network Control Service available from the Facility and any limitations on the time periods for which the Network Control Service will be available, including where applicable:
 1. times of the day, of the week, or of the year for which the Facility will not be available to provide the Network Control Service, or will only be able to provide the service in reduced quantity or subject to other restrictions;
 2. a maximum number of times which the Facility may be called upon to provide the Network Control Service in a time period;
 3. the maximum duration of each occasion when the Facility may be called upon to provide the Network Control Service; and
 4. a maximum cumulative duration for which the Facility may be called upon to provide the Network Control Service in a time period;
- iv. availability of the Facility, including arrangements when Planned Outages are scheduled;
- v. the notice period for calling on the Facility to provide the Network Control Service;
- vi. whether the IMO must accept the entire quantity offered, or whether it can accept a part of the quantity offered;
- vii. an offered Monthly Availability Payment amount in dollars; and
- viii. an offered per MWh price to apply when the Facility is called upon to provide the Network Control Service; and

If the tenderer is successful, the Monthly Availability Payment will be the minimum revenue that the IMO guarantees. The offered per MWh price will go into standing data, and will be the price paid when the facility is called on (although the facility may also operate in the energy market at other times using bilateral and STEM submissions like an other facility).

Note that just like any other generation facility, a tender responder offering a generation facility will be paying for connection to the network, and the Monthly Availability Payment should take this into account – i.e. the network is not separately paying for the generator to connect.

- (e) process details for submitting tenders.

5.4.5. A Market Participant or the Network Operator referred to in clause 5.2.1 may respond to the invitation to tender by submitting written tenders in the form, and by the date, specified in the invitation to tender. A Market Participant or the Network Operator

Chapter 5

referred to in clause 5.2.1 may offer for all or part of the Network Control Service requirements.

5.4.6. A Market Participant submitting a tender in response to an invitation to tender must not offer more capacity than is indicated by the relevant Network Control Service Certification.

5.4.7. A Market Participant submitting a tender in response to an invitation to tender must not offer a per MWh price to apply when the Facility is called upon to provide the Network Control Service that is greater than the Alternative Maximum STEM Price.

Note that this may need to be reconsidered, especially with respect to arrangements for DSM, which might have a very low monthly cost, but high per MWh costs.

5.4.8. In determining the result of a tender process, and entering into Network Control Service Contracts, the IMO must seek to achieve the lowest total cost of the tenders selected, evaluating each tender on the basis of:

- (a) the offered Monthly Availability Payment amount contained in the tender;
- (b) plus an amount equal to:
 - i. the offered per MWh price to apply when the Facility is called upon to provide the Network Control Service contained in the tender;
 - ii. multiplied by the estimated number of hours per year that the services would be required specified in accordance with clause 5.2.1(a)(ii) divided by 12.

We may need to develop this further into a net present value calculation, given the different economic lifetimes of transmission, generation and DSM options, and potentially increasing use of the services over time. If a net present value calculation was used, one issue would be the appropriate discount rates to use

So the IMO might accept several tender responses that together meet the requirement at the lowest cost.

5.4.9. The IMO is not under any obligation to accept any tender, or enter into a Network Control Service Contract in respect of any tender, made in response to an invitation to tender under this clause 5.4. However, where the IMO accepts a tender, it must accept it in relation to the entire quantity offered unless the relevant Market Participant or Network Operator indicated that the IMO may accept a part of the quantity offered.

5.4.10. The IMO must notify each Market Participant and Network Operator that submitted a tender as to whether it has been successful by the date specified in accordance with clause 5.4.1(d).

Chapter 5

5.4.11. Where a selected tender response is not from the Network Operator referred to in clause 5.2.1, then the IMO and the selected Market Participant must execute a Network Control Service Contract.

If a generation option is successful in the tender, then the successful tenderer enters a Network Control Service Contract with System Management for ten years.

If the original transmission option is the successful bidder, then no Network Control Service Contract is needed. The Network Operator will simply proceed with the project, and the ERA will review whether the capital expenditure was justified under the Access Code.

5.4.12. Where a selected tender response is not from the Network Operator referred to in clause 5.2.1, then the selected Market Participant must apply to the IMO for Certified Reserve Capacity in respect of each of the Facilities set out in the selected tender response, in respect of each Reserve Capacity Cycle that each Facility would be eligible to participate in over the period for which Network Control Services will be provided under the relevant Network Control Service Contract.

5.4.13. Where a Market Participant executes a Network Control Service Contract pertaining to a Facility, the Market Participant must ensure that the Facility is registered as a Registered Facility during the period for which Network Control Services are to be provided under the Network Control Service Contract.

5.4.14. The IMO must document the procedure it follows in carrying out Network Control Service tender processes in the Network Control Service Procedure, and:

- (a) the IMO must follow that documented Market Procedure when carrying out tender processes under this clause 5.4; and:
- (b) Market Participants and Network Operators must follow that documented Market Procedure when participating in a tender process under this clause 5.4.

Network Control Service Contracts

5.5. Contract Conditions

5.5.1. Prior to the first tender process under clause 5.4, the IMO must develop a standard form Network Control Service Contract which accords with the requirements of this clause 5.5.

5.5.2. The IMO must consult with System Management when developing or amending the standard contractual terms.

5.5.3. A standard form Network Control Service Contract must contain the following:

- (a) the Network Control Service being provided;

Chapter 5

- (b) the duration of the contract, in accordance with clause 5.2.2, and specifying any extension options;
- (c) the procedures for the IMO, via System Management, to call on the Facility to provide the service, including:
 - i. operational arrangements under which the IMO will allow System Management to call on the relevant Facility to provide the service;
 - ii. the quantities of the service that will be provided, including where applicable, any limitations on the time periods for which the relevant Facility can be called on to provide the service, including:
 - 1. times of the day, or of the week, or of the year at which the relevant Facility cannot be called on to provide the service, or can only be called on to provide the service in reduced quantity or with other restrictions;
 - 2. a maximum number of times which the relevant Facility can be called on to provide the service, in a week, or in a year, as applicable;
 - 3. the maximum duration of each occasion when the relevant Facility can be called on to provide the service; and
 - 4. a maximum cumulative duration for which the relevant Facility can be called on to provide the Network Control Service in a day, or in a week, or in a year, as applicable.
 - iii. availability of the service, including arrangements when Planned Outages of the Facility are scheduled; and
 - iv. the notice period for calling on the relevant Facility to provide the service.
- (d) the Facility that will provide the service, and a requirement that the Facility is registered as a Registered Facility during the period for which Network Control Service are to be provided;
- (e) any conditions required to ensure that if the relevant Facility is transferred or disposed of, the transferee will be bound by the contract obligations (for example, by requiring the execution of a deed of assumption or novation);
- (f) the technical standards which the relevant Facility must comply with;
- (g) the Monthly Availability Payment and monthly payment terms, which must be in accordance with clause 5.8;
- (h) the per MWh price to apply when the Facility is called upon to provide the service;
- (i) measurement of the quantity of service provided;

- (j) compliance standards, testing procedures and liquidated damages for the Market Participant, which must be in accordance with clause 5.6;
- (k) procedures for the Market Participant to inform the IMO and System Management when the capability of any of the relevant Facilities to provide the service changes materially;
- (l) contract modification procedures;
- (m) provisions dealing with contract suspension, default, termination, force majeure conditions, and assignment; and
- (n) such other terms and conditions as the IMO considers appropriate.

The standard form may contain different terms depending on the type and location of Facility, the type of Network Control Service, the service provider and other relevant factors.

5.5.4. Despite the existence of the standard form Network Control Service Contract, the IMO may enter into a Network Control Service Contract that varies from the standard form Network Control Service Contract. The IMO must consult with System Management before entering into a Network Control Service Contract that varies substantially from the terms of the standard form.

5.6. Network Control Service Contract Compliance Conditions

- 5.6.1. Testing processes, compliance processes and non-compliance liquidated damages are to be defined within each Network Control Service Contract.
- 5.6.2. If the Market Participant fails to provide a Network Control Service in the quantity and at the time and location requested by the IMO or System Management in accordance with the contract, the IMO and the Market Participant must follow the procedure in the Network Control Service Contract.
- 5.6.3. A Network Control Service Contract must contain a procedure to be used following the failure of a Market Participant to provide a Network Control Service in the quantity and at the time and location requested by the IMO or System Management in accordance with the contract, and this procedure must include:
 - (a) a requirement that the IMO must issue to the Market Participant a request for:
 - i. a written explanation; and
 - ii. a written plan to remedy the failure;
 - (b) a requirement that the Market Participant must respond to the request within five Business Days of receiving the request; and
 - (c) if the IMO finds the explanation or the plan to remedy the failure to be unsatisfactory, then it may, in accordance with the Network Control Service Contract:

- i. require a test of the Registered Facility's ability to provide the Network Control Service in accordance with the contract terms. The Market Participant must bear its own costs associated with the tests; and
- ii. withhold or reduce the Market Participant's payments for the Network Control Service for a period.

5.7. Network Control Service Dispatch

- 5.7.1. The IMO must provide System Management with the details of the Network Control Services Contract to enable System Management to dispatch the services provided under it. Despite this, the IMO must not provide System Management with the payment terms of the contract, which must be kept confidential.
- 5.7.2. System Management may call upon the relevant Facility to provide services under a Network Control Services Contract in accordance with the terms of the contract.
- 5.7.3. The Standing Data price for increases in generation or decreases in consumption, as applicable, for any Registered Facility providing Network Control Service must be the value specified in the Network Control Services Contract in accordance with clause 5.5.3(h).
- 5.7.4. System Management must document the procedure it will follow in calling on Registered Facilities to provide services under Network Control Service Contracts in the Power System Operation Procedure, and System Management must follow that documented Market Procedure when calling on Registered Facilities to provide services under Network Control Service Contracts.

Under the Procedure development Rules, System Management must gain IMO approval for this Procedure.

Payments and Settlement Data

5.8. Network Control Service Contracts Payments

The basic payment for Network Control Service will only be a capacity payment. This is because the facility can ensure that it recovers its energy costs via the pay-as-bid regime employed in balancing. The capacity payment will be a fixed monthly payment, from which the value of Reserve Capacity earnings by the provider, and any liquidated damages due to failing to meet the obligations of the contract, will be subtracted. It will not be possible for this payment to ever be negative. If this value of the Monthly Availability Payment, less reductions, is greater than zero, then the IMO will charge this cost to the Network Operator to recover from network charges. If the facility earns more in the Reserve Capacity mechanism than the Monthly Availability Payment, then the Network Operator will not need to make any payment.

Chapter 5

For the purpose of estimating the value of Reserve Capacity, the IMO will use the prevailing Monthly Reserve Capacity Price as the basis for valuing bilateral trades of Capacity Credits for which it has no other basis of setting the price (e.g. because the facility has a Special Price Arrangement).

5.8.1. The monthly Network Control Service Contract payment to a Market Participant that has a Network Control Service Contract with the IMO in respect of a Facility is to be the greater of zero and:

The Monthly Availability Payment is a fixed \$ amount. This is the amount bid in the tender 5.4.4(d)(vii), and appears in the contract 5.5.3(g). From this the IMO subtracts an amount for the Reserve Capacity the facilities have, and any non-performance amounts. If the result is more than zero then the IMO pays this to the provider, otherwise no payment is made. Note that this means that the liquidated damages are capped at the Monthly Availability Payment in any month.

- (a) the Monthly Availability Payment determined in accordance with the contract; less
- (b) the value of Capacity Credits held by the Market Participant for that Facility, where this value is the sum of the total value of all of those Capacity Credits, where each Capacity Credit is valued at the applicable Monthly Reserve Capacity Price even if those Capacity Credits are traded bilaterally; less
- (c) the value of any liquidated damages payable under the contract in respect of a failure of the Market Participant to meet its obligations under the Network Control Service Contract.

5.8.2. The IMO must pay the Market Participant the monthly Network Control Service Contract payment in accordance with Chapter 9.

5.8.3. The Network Operator referred to in clause 5.2.1 must pay the IMO the monthly Network Control Service Contract payment in accordance with Chapter 9.

5.8.4. After receiving the notification described in clause 5.2.1 but before commencing Network Control Services procurement, the IMO may estimate the costs described in clause 5.8.5(a), and invoice the Network Operator referred to in clause 5.2.1 for the estimated amount.

5.8.5. The IMO must determine the dollar amount that is:

- (a) the costs it has incurred in:
 - i. the expression of interest process described in clause 5.2;
 - ii. the certification process described in clause 5.3;
 - iii. the tender process described in clause 5.4,in respect of any tender process for Network Control Services

Chapter 5

- (b) less the amount received under any relevant invoice issued under clause 5.8.4.

5.8.6. Where the dollar amount determined in clause 5.8.4 is a positive amount, the IMO must issue an invoice to the Network Operator referred to in clause 5.2.1, and subject to clause 5.8.8, the Network Operator must pay the IMO the invoiced amount.

5.8.7. Where the dollar amount determined in clause 5.8.4 is a negative amount, the IMO must issue an invoice the Network Operator referred to in clause 5.2.1, and subject to clause 5.8.8, the IMO must pay the Network Operator the determined amount.

5.8.8. Where the Network Operator disputes the amount on an invoice issued under clauses 5.8.4, 5.8.6 or 5.8.7, the dispute resolution process set out in clauses 2.18 to 2.20 apply.

5.9. Settlement Data

5.9.1. The IMO must provide the following information to the settlement system:

- (a) for each month's Network Control Service Contract Payment:
 - i. the amount of the payment;
 - ii. the Market Participant to which the payment will be made; and
 - iii. the Network Operator by which the payment will be made.

6. The Energy Market

Energy Scheduling Timetable and Process

The energy scheduling process comprises:

Any time (though with restrictions on the time of day).

Standing Balancing Submissions, Standing STEM Submissions, Standing Resource Plans and Standing Balancing Data (i.e. pay-as-bid balancing prices) submitted.

Between a week ahead and a day ahead

Bilateral Submissions, which contain schedules of bilateral contracts, submitted by generators. Standing Bilateral Submissions are used if this data is not provided.

A day ahead

STEM Submissions, from which the IMO determines STEM Bids and STEM Offers given each Market Participant's Net Bilateral Position. Standing STEM Submissions are used if this data is not provided.

A STEM auction run by the IMO, using STEM Bids and STEM Offers.

Resource Plan Submissions, which detail how the participant will use their generation facilities to meet their net contract position. Standing Resource Plan Submissions will be used if this data is not available – however, since these will be validated against the Net Contract Position on the day, this feature can only realistically be used by Market Participants with the same schedules every day.

Balancing Data submissions, which detail the pay-as-bid Balancing Prices to be paid for increases and decreases in energy output stemming from Dispatch Instructions. Standing Balancing Data is used if this data is not provided. Note that Standing Balancing Data is stored with the registration data provided with a facility and is changed through updating the registered value (rather than via changes through the trading system).

6.1. [Blank]

6.2. Bilateral Submission Timetable and Process

6.2.1. A Market Generator may submit Bilateral Submission data for a Trading Day to the IMO between:

- (a) 8:00 AM of the day seven days prior to the start of the Scheduling Day for the Trading Day; and
- (b) 8:50 AM on the Scheduling Day for the Trading Day.

Chapter 6

6.2.2. Where the IMO holds a Standing Bilateral Submission for a Market Generator as at the time specified in clause 6.2.1(a), where that Standing Bilateral Submission is applicable to the Trading Day to which clause 6.2.1 relates and where that Standing Bilateral Submission conforms to the requirements of clause 6.7 at that time, the IMO must make it the Bilateral Submission with respect to the Trading Day as at the time specified in clause 6.2.1(a).

6.2.2A. When the IMO receives Bilateral Submission data from a Market Generator during the time interval described in clause 6.2.1, it must as soon as practical communicate to that Market Generator whether or not the IMO accepts the data as conforming to the requirements of clause 6.7. Where the IMO accepts the data then the IMO must revise the Bilateral Submission to reflect that data.

6.2.3. By 8:30 AM on each Scheduling Day the IMO must communicate to each Market Participant a list of the Bilateral Submission quantities associated with that Market Participant for each Trading Interval on the Trading Day, including the party supplying, or being supplied by, the Market Participant., where this information must be based on Bilateral Submissions held by the IMO at a time not earlier than 8:20 AM on the Scheduling Day.

6.2.4. [Blank]

6.2.4A. [Blank]

6.2.4B. A Market Generator may cancel Bilateral Submission data held by the IMO for any Trading Interval of the Trading Day during the time interval specified in clause 6.2.1.

6.2.4C. The IMO must confirm to the Market Generator any cancellation of Bilateral Submission data made in accordance with clause 6.2.4B. Where such cancellation is made then the IMO must remove the relevant data from the Bilateral Submission.

6.2.5. [Blank]

6.2.6. [Blank]

6.2.7. By making or revising a Bilateral Submission a Market Participant acknowledges that it is acting with the permission of all affected Market Participants.

There will be no process for re-submitting information in the event of an error. Instead the submitting Market Participant will have to address any errors under its contract with the other Market Participant(s) involved in its submission.

6.2.8. By 9:00 AM on each Scheduling Day the IMO must communicate to each Market Participant a list of the Bilateral Submission quantities associated with that Market Participant for each Trading Interval on the Trading Day, including the party supplying, or being supplied by, the Market Participant.

6.2A. Standing Bilateral Submission Timetable and Process

6.2A.1. A Market Generator may submit Standing Bilateral Submission data to the IMO on any day between the times of:

- (a) 1:00 PM; and
- (b) 3:50 PM,

where if accepted by the IMO the data will apply from the commencement of the subsequent Scheduling Day.

The window for normal bilateral submissions is open for a week. Since this data becomes active from the opening of the normal bilateral submission, this means that standing bilateral submission data submitted on Monday afternoon will first become available for use as a bilateral submission on the Scheduling Day beginning on Tuesday, but since the window that opens on that day for bilateral submissions relates to the Scheduling Day on Tuesday the following week for the Trading Day on Wednesday of that following Week.

6.2A.2. When the IMO receives Standing Bilateral Submission data from a Market Generator during the time interval described in clause 6.2A.1 it must as soon as practical communicate to that Market Generator whether or not the IMO accepts the data as conforming to the requirements of clause 6.7. Where the IMO accepts the data then the IMO must revise the Standing Bilateral Submission to reflect that data.

6.2A.3. Standing Bilateral Submission data must be associated with a day of the week and when used as Bilateral Submission data will only apply to Trading Days commencing on that day of the week.

6.2A.4. A Market Generator may cancel Standing Bilateral Submission data held by the IMO for any Trading Interval of the Trading Day during the time interval specified in clause 6.2A.1.

6.2A.5. The IMO must confirm to the Market Generator any cancellation of Standing Bilateral Submission data made in accordance with clause 6.2A.4. Where such cancellation is made then the IMO must remove the relevant data from the Standing Bilateral Submission.

6.3. [Blank]

6.3A. Information to Support the Bilateral and STEM Submission Process

6.3A.1. The IMO must publish the following information:

- (a) by 8:00 AM of each Scheduling Day to support the Bilateral Submission process the Load Forecast in MWh and MW as measured at the Reference Node for each of the Trading Intervals of the Trading Day determined in

Chapter 6

accordance with clauses 7.2.1(a) as provided to the IMO by System Management in accordance with clauses 7.2.3B or 7.2.3C;

- (b) by 9:00 AM of each Scheduling Day to support the STEM Submission process:
- i. the total energy, in MWh as measured at the Reference Node, scheduled with the IMO under bilateral contracts for each of the Trading Intervals of the Trading Day; and
 - ii. the estimated residual Reserve Capacity available in each of the Trading Intervals of the Trading Day after netting off the quantity in (a).

This will have to be an estimate since Reserve Capacity is a capacity quantity whereas the energy traded is a MWh quantity.

6.3A.2. By 9:00 AM on the Scheduling Day the IMO must have calculated and released to each Market Participant the following parameters to be respected by that Market Participant in forming its STEM Submissions for each Trading Interval in the Trading Day:

The Maximum Supply Capability and Maximum Consumption Capability define the maximum quantity that can be supplied or consumed via Bilateral Contracts and STEM Submissions. The reason for determining the available capacity for each generator in (c) and (d) is so that Market Participants can confirm the factors they must respect when forming their STEM Submissions. Note that if for any reason System Management has not notified the IMO of an outage, then the IMO is just restating Standing Data values.

A Market Participant must not exceed its Maximum Supply Capability or Maximum Consumption Capability in forming STEM Submissions for a Trading Interval. The amount of generation it can offer at the Alternative Maximum STEM Price will be the sum of all the energy from generators described in (c) and the sum of the energy from those generators described in (d) for which the Market Participant makes a Fuel Declaration stating that the facility will be running on Liquid Fuel for the Trading Interval.

- (a) the Maximum Supply Capability where this equals the maximum Loss Factor adjusted quantity of energy, in units of MWh, that could be supplied during the Trading Interval based on the Standing Data of that Market Participant's Scheduled Generators and Non-Scheduled Generators and assuming the use of the fuel which maximises the capacity of each Facility:
- i. less an allowance for outages of which the IMO has been made aware by System Management in accordance with clauses 7.3.4 or 7.3.6; and
 - ii. less, for each Market Participant that is a provider of Ancillary Services, the estimated Loss Factor adjusted quantity of energy, in units of MWh, that could potentially be called upon by System Management from that Market Participant after 1:00 PM on the

Scheduling Day to meet Ancillary Service requirements for each Trading Interval of the Trading Day, as provided to the IMO by System Management in accordance with clauses 7.2.3B or 7.2.3C;

- (b) the Maximum Consumption Capability where this equals the maximum Loss Factor adjusted quantity of energy, in units of MWh, that could be consumed during a Trading Interval by that Market Participant's Non-Dispatchable Loads, Interruptible Loads, Curtailable Loads and Dispatchable Loads based on the Standing Data maximum consumption quantities for those Facilities and Non-Dispatchable Loads, less an allowance for outages of which the IMO has been made aware by System Management in accordance with clauses 7.3.4 or 7.3.6;
- (c) for each Scheduled Generator and Non-Scheduled Generator that is registered as being able to run on Liquid Fuel only, the maximum Loss Factor adjusted quantity of energy, in units of MWh, that could be supplied during the Trading Interval based on the Standing Data of that Scheduled Generator or Non-Scheduled Generator less an allowance for outages of which the IMO has been made aware by System Management in accordance with clauses 7.3.4 or 7.3.6; and
- (d) for each Scheduled Generator and Non-Scheduled Generator that is registered as being able to run on both Liquid Fuel and Non-Liquid Fuel, the maximum Loss Factor adjusted quantity of energy, in units of MWh, that could be supplied during the Trading Interval when run on each of Liquid Fuel and Non-Liquid Fuel based on the Standing Data of that Scheduled Generator or Non-Scheduled Generator less an allowance for outages of which the IMO has been made aware by System Management in accordance with clauses 7.3.4 or 7.3.6.
- (e) in the case of each Market Participant that is a provider of Ancillary Services:
 - i. the estimated Loss Factor adjusted quantity of energy, in units of MWh, that could potentially be called upon by System Management after 1:00 PM on the Scheduling Day to meet Ancillary Service requirements for each Trading Interval of the Trading Day; and
 - ii. the list of Facilities that System Management might reasonably expect to call upon to provide the energy described in (i),as provided to the IMO by the System Management in accordance with clauses 7.2.3B or 7.2.3C.

The Maximum Supply Capability and Maximum Demand Capability define the maximum quantity that can be supplied or consumed via bilateral contracts and STEM submissions. The reason for determining the available capacity for each generator in (c) and (d) is so that Market Participants can confirm the factors they must respect when making their STEM submissions. Note that if for any reason System Management has not notified the IMO of an outage, then the IMO is just restating Standing Data values.

A Market Participant must not exceed its Maximum Supply Capability or Maximum Demand Capability in forming STEM Submissions for a Trading Interval. The amount of generation it can offer at the Alternative Maximum STEM Price will be the sum of all the energy from generators described in (c) and the sum of the energy from those generators described in (d) for which the Market Participant makes a Fuel Declaration stating that the facility will be running on Liquid Fuel for the Trading Interval.

6.3B. STEM Submissions Timetable and Process

STEM Submissions are for the Trading Day that commences at 8:00 AM on the following day.

6.3B.1. A Market Participant may submit STEM Submission data for a Trading Day to the IMO between:

- (a) 9:00 AM on the Scheduling Day; and
- (b) 9:50 AM on the Scheduling Day.

A Market Participant holding Capacity Credits must make daily STEM Submissions (or have a Standing STEM Submission) that covers the obligations of its Capacity Credits.

6.3B.1A. Where the IMO holds a Standing STEM Submission for a Market Participant as at the time specified in clause 6.3B.1(a), where that Standing STEM Submission is applicable to the Trading Day to which clause 6.3B.1 relates and where that Standing STEM Submission conforms to the requirements of clause 6.6 at that time, the IMO must make it the STEM Submission with respect to the Trading Day as at the time specified in clause 6.3B.1(a).

6.3B.2. For the purposes of clauses 6.3B.3(c) the IMO must assess received STEM Submission data against the Reserve Capacity Obligations of the Market Participant that apply at 41°C.

6.3B.3. When the IMO receives STEM Submission data from a Market Participant during the time interval described in clause 6.3B.1 it must as soon as practical communicate to that Market Participant:

- (a) [Blank]
- (b) whether or not the IMO accepts the received STEM Submission data as conforming to the requirements of clause 6.6; and
- (c) the extent to which the IMO considers that received STEM Submission data is consistent with the Market Participant's Reserve Capacity Obligations assessed under clause 6.3B.2;

where, if the IMO accepts the data, the STEM Submission held by the IMO must be revised to reflect that data.

Chapter 6

6.3B.4. [Blank]

6.3B.5. [Blank]

6.3B.6. [Blank]

6.3B.7. [Blank]

6.3B.7A. A Market Participant may cancel STEM Submission data held by the IMO for any Trading Interval of the Trading Day during the time interval specified in clause 6.3B.1.

6.3B.7B. The IMO must confirm to the Market Participant any cancellation of STEM Submission data made in accordance with clause 6.3B.7A. Where such cancellation is made then the IMO must remove the relevant data from the STEM Submission.

6.3B.8. Where the IMO does not receive a STEM Submission from a Market Participant by the time specified in clause 6.3B.1(b) on the Scheduling Day, which is accepted in accordance with clause 6.3B.3(b) then the IMO must record that no STEM Submission has been made.

6.3C. Standing STEM Submission Timetable and Process

A Standing STEM Submission has data for each day of the week and first applies to the Scheduling Day (for the Trading Day) that commences at 8:00 AM on the day following the day on which the Standing STEM Submission is accepted by the IMO.

6.3C.1. A Market Participant may submit Standing STEM Submission data to the IMO on any day between the times of:

(a) 1:00 PM; and

(b) 3:50 PM,

where if accepted by the IMO the data will apply from the commencement of the subsequent Scheduling Day.

6.3C.2. For the purposes of clauses 6.3C.3(c) the IMO must assess received Standing STEM Submission data against the Reserve Capacity Obligations of the Market Participant that apply at 41°C.

6.3C.3. When the IMO receives Standing STEM Submission data from a Market Participant during the time interval described in clause 6.3C.1 it must as soon as practical communicate to that Market Participant:

(a) whether or not the IMO accepts received Standing STEM Submission data as conforming to the requirements of clause 6.6; and

Chapter 6

- (b) the extent to which the IMO considers that received Standing STEM Submission data is consistent with the Market Participant's Reserve Capacity Obligations assessed under clause 6.3C.2 in each Trading Interval of the next seven Trading Days;

where, if the IMO accepts the data, the IMO must revise the Standing STEM Submission to reflect that data.

A Standing STEM Submission includes seven Trading Days worth of data (where each applies for a different day of the week). Given that a Market Participant's Reserve Capacity Obligations could be changing over time (due to Planned Outages etc) then the test in (b) is rather crude, but there is little more that can be done. Note that failure to cover Reserve Capacity Obligations will not cause the IMO to reject Standing STEM Submission data. The information provided to Market Participants in (b) is simply to warn them that they may be exposed to Reserve Capacity Refunds.

6.3C.4. [Blank]

6.3C.5. [Blank]

6.3C.6. [Blank]

6.3C.6A. Standing STEM Submission data must be associated with a day of the week and when used as STEM Submission data will only apply to Trading Days commencing on that day of the week.

6.3C.6B. A Market Participant may cancel Standing STEM Submission data held by the IMO for any Trading Interval of the Trading Day during the time interval specified in clause 6.3C.1.

6.3C.6C. The IMO must confirm to the Market Participant any cancellation of Standing STEM Submission data made in accordance with clause 6.3C.6B. Where such cancellation is made then the IMO must remove the relevant data from the Standing STEM Submission.

6.3C.7. [Blank]

6.3C.8. [Blank]

6.3C.9. If a Market Participant's ability to consume or supply energy in any Trading Interval of a Trading Day is less than the maximum level of its STEM supply or consumption as indicated by its current Standing STEM Submission then that Market Participant must either:

- (a) submit to the IMO Standing STEM Submission data so as to revise its Standing STEM Submission to comply with this clause 6.3C.9; or

- (b) for each Trading Interval for which the current Standing STEM Submission over-states the Market Participants supply or consumption capabilities, submit valid STEM Submission data to the IMO on the Scheduling Day immediately prior to that Trading Day.

6.4. The STEM Auction Timetable and Process

6.4.1. The IMO must undertake the process described in clause 6.9 and determine the STEM Auction results for a Trading Day no earlier than at 10:00 AM, and no later than 10:30 AM, on the relevant Scheduling Day;

6.4.2. The IMO must communicate to System Management the total quantity of energy scheduled to be supplied under Bilateral Contracts and in the STEM Auction, by each Market Participant, for each Trading Interval of a Trading Day by 10:30 AM on the relevant Scheduling Day.

The notification in clause 6.4.2 is primarily for information purposes.

6.4.3. The IMO must communicate to each Market Participant the following information in relation to a Trading Day by 10:30 AM on the relevant Scheduling Day:

- (a) the Trading Intervals, if any, in which the STEM Auction was suspended;
- (b) the STEM Clearing Price in all Trading Intervals for which the STEM was not suspended;

Note that, unless it is suspended because of IT problems, the STEM will always produce a “clearing price”, even when the quantities traded are zero. The clauses in 6.9 mean that the aggregate offer curve and aggregate demand curve always cross, even if this is at zero quantity, and produce a price that is the marginal price for supply or demand.

- (c) the quantities scheduled in respect of that Market Participant in the STEM Auction for each Trading Interval; and
- (d) the Net Contract Position of the Market Participant in each Trading Interval, as determined in accordance with clause 6.9.13.

This will be the sum of the energy sold under bilaterals, minus the energy purchased under bilaterals, plus energy sold via the STEM, minus energy purchased via the STEM.

6.4.4. Market Participants must confirm receipt of the communication described in clause 6.4.3 for a Trading Day by 10:45 AM on the relevant Scheduling Day.

6.4.5. If the IMO does not receive confirmation of receipt by a Market Participant of the information described in clause 6.4.3 for a Trading Day by 10:45 AM of the relevant Scheduling Day, it must use reasonable endeavours to contact the affected Market Participant to ensure that at least the information in clauses 6.4.3(c) and 6.4.3(d) is conveyed to the Market Participant by 11:00 AM.

Chapter 6

6.5. Resource Plan Submission Timetable and Process

Market Participants providing Capacity Credits will have additional obligations to ensure that their Capacity Credit obligations are covered.

6.5.1. Market Participants other than the Electricity Generation Corporation may submit Resource Plan Submission data for a Trading Day to the IMO between:

- (a) 11:00 AM on the Scheduling Day; and
- (b) 12:50 PM on the Scheduling Day.

6.5.1A. Market Participants that are Market Generators or that are Market Customers with Dispatchable Load must provide the IMO with a Resource Plan Submission, either via submitting Resource Plan Submissions or in accordance with clause 6.5.1B.

6.5.1B. Where the IMO holds a Standing Resource Plan Submission for a Market Participant as at the time specified in clause 6.5.1(a) where that Standing Resource Plan Submission is applicable to the Trading Day to which clause 6.5.1 relates then, provided that Standing Resource Plan Submission data is accepted by the IMO in accordance with clause 6.5.2, it becomes the Resource Plan Submission with respect to the Trading Day as at the time specified in clause 6.5.1(a).

6.5.2. When the IMO receives Balancing Data Submission data from a Market Participant during the time interval described in clause 6.5A.1 it must as soon as practical communicate to that Market Participant whether or not the IMO accepts the data as conforming to the requirements of clause 6.11A.2. Where the IMO accepts the data then the IMO must revise the Balancing Data Submission to reflect that data.

- (a) [Blank]
- (b) [Blank]

6.5.3. [Blank]

6.5.3A [Blank]

6.5.4. If the IMO has not accepted a Resource Plan Submission for a Trading Day by 1 PM on the relevant Scheduling Day from a Market Participant that is required to make a Resource Plan Submission, then it must prepare a default Resource Plan for that Market Participant which must include, for each Trading Interval on the Trading Day:

- (a) all the Market Participant's Scheduled Generators and Non-Scheduled Generators having a scheduled output of zero;
- (b) all Dispatchable Loads having a scheduled consumption of zero; and
- (c) the level of the supply shortfall required pursuant to clause 6.11.1(e) equal to the total Net Contract Position.

Chapter 6

6.5.5. [Blank]

6.5A. Balancing Data Submission Timetable and Process

A Balancing Data Submission contains pay-as-bid price data to be used in balancing. If no submission is provided then Standing Data will be used. Note that commitment costs are not included in Balancing Data as Appendix 1 requires that supporting evidence be provided for changes to that data. The timelines and processes parallel those for Resource Plan Submissions. Note that the only “Standing Balancing Data” will be the data stored with a Facilities Registration Data – this data will be changed in the same way that a Market Participant would change a ramp rate, rather than being a change made through the trading systems.

6.5A.1. Market Participants other than the Electricity Generation Corporation that are Market Generators or that are Market Customers with Dispatchable Loads or Curtailable Loads may submit Balancing Data Submission data for a Trading Day to the IMO between:

- (a) 11:00 AM on the Scheduling Day; and
- (b) 12:50 PM on the Scheduling Day.

6.5A.1A. Where the IMO holds Standing Balancing Data for a Market Participant as at the time specified in clause 6.5A.1(a), where that Standing Balancing Data is applicable to the Trading Day to which clause 6.5A.1 relates and where that Standing Balancing Data conforms to the requirements of clause 6.11A.2, the IMO must make it the Balancing Data Submission with respect to the Trading Day as at the time specified in clause 6.5A.1(a).

6.5A.2. When the IMO receives Balancing Data Submission data from a Market Participant during the time interval described in clause 6.5A.1, or a Balancing Data Submission is derived from Standing Balancing Data in accordance with clause 6.5A.1A, it must as soon as practical communicate to that Market Participant whether or not the IMO accepts the data as conforming to the requirements of clause 6.11A.2. Where the IMO accepts the data then the IMO must revise the Balancing Data Submission to reflect that data.

- (a) [Blank]
- (b) [Blank]

6.5A.3. [Blank]

6.5A.4. [Blank]

6.5A.5. [Blank]

6.5B. [Blank]

6.5C. Standing Resource Plan Submission Timetable and Process

A Standing Resource Plan Submission has data for each day of the week and first applies to the Scheduling Day (for the Trading Day) that commences at 8:00 AM on the day following the day on which the Standing Resource Plan Submission is accepted by the IMO.

6.5C.1. A Market Participant may submit Standing Resource Plan Submission data on any day between the times of:

(a) 1:00 PM; and

(b) 3:50 PM;

where if accepted by the IMO the data will apply from the commencement of the subsequent Scheduling Day.

6.5C.2. When the IMO receives Standing STEM Resource Plan data from a Market Participant during the time interval described in clause 6.5C.1 it must as soon as practical communicate to that Market Participant whether or not the IMO accepts the received data as conforming to the requirements of clause 6.11.2; and where the IMO accepts the data then the IMO must revise the Standing Resource Plan Submission to reflect that data.

6.5C.3. Standing Resource Plan Submission data must be associated with a day of the week and when used as a Resource Plan Submission will only apply to Trading Days commencing on that day of the week.

6.5C.4. A Market Participant may cancel Standing Resource Plan Submission data held by the IMO for any Trading Interval of the Trading Day during the time interval specified in clause 6.5C.1.

6.5C.5. The IMO must confirm to the Market Participant any cancellation of Standing Resource Plan Submission data made in accordance with clause 6.5C.4. Where such cancellation is made then the IMO must remove the relevant data from the Resource Plan Submission.

6.5C.6. If a Market Participant's ability to consume or supply energy in any Trading Interval of a Trading Day is less than the maximum level of its supply or consumption as indicated by its Standing Resource Plan Submission then that Market Participant must either:

(a) submit to the IMO Standing Resource Plan Submission data so as to revise its Standing Resource Plan Submission to comply with this clause 6.5C.6; or

(b) for each Trading Interval for which the Standing Resource Plan Submission over-states the Market Participants supply or consumption capabilities, submit

valid Resource Plan Submission data to the IMO on the Scheduling Day immediately prior to that Trading Day.

6.5C.7. If on a Scheduling Day at the time described in clause 6.5.1(a), a Market Participant's Standing Resource Plan Submission applicable to any Trading Interval of the corresponding Trading Day is inconsistent with its Net Contract Position for that Trading Interval then that Market Participant must submit valid Resource Plan Submission data to the IMO for that Trading Interval in accordance with clause 6.5.1.

STEM Submission and Bilateral Submission Formats

6.6. Format of STEM Submission and Standing STEM Submission Data

6.6.1. A Market Participant submitting STEM Submission data or a Standing STEM Submission data must include in the submission:

- (a) the identity of the Market Participant making the submission;
- (b) [Blank]
- (c) for STEM Submission data, for each Trading Interval included in the submission:
 - i. a Fuel Declaration;
 - ii. an Availability Declaration;
 - iii. if the Market Participant is a provider of Ancillary Services, an Ancillary Service Declaration;
 - iv. a Portfolio Supply Curve; and
 - v. a Portfolio Demand Curve;
- (d) for Standing STEM Submission data, the day of the week to which the submission relates, where data provided for a day of the week relates to the Trading Day commencing on that day, and for each Trading Interval included in the submission:

A Standing STEM Submission can be made for Monday through to Sunday, where data for the Trading Day commencing Tuesday will be used for Trading Days commencing on Tuesdays.

- i. a Fuel Declaration;
- ii. an Availability Declaration;
- iii. if the Market Participant is a provider of Ancillary Services, an Ancillary Service Declaration;
- iv. a Portfolio Supply Curve; and
- v. a Portfolio Demand Curve.

Chapter 6

For a Standing STEM Submission the Availability Declaration and Ancillary Service Declarations still need to be provided, even though this may be prior to outage data being finalised and prior to Ancillary Service requirements being specified. Thus we might expect such values to be conservative (or the Market Participant will have to correct any discrepancies by submitting data on the Scheduling Day).

6.6.2. [Blank]

6.6.2A For:

(a) a Fuel Declaration:

- i. the Market Participant must declare for each of its dual fuel Facilities whether or not that Facility was assumed to be operating on Liquid Fuel or Non-Liquid Fuel in forming the Portfolio Supply Curve;

(b) an Availability Declaration:

The declaration is of capacity not available, as such declarations should be rarely required. If the declaration was for capacity available then (a) it would have to be made every day and (b) creates risk of having a submission rejected if it exceeds the IMO's expectations.

- i. the Market Participant must declare for each of its Scheduled Generators and Non-Scheduled Generators:

1. the quantity specified for that Facility in clause 6.3A.2(d) for the fuel indicated in its Fuel Declaration; less
2. the quantity of energy assumed to be available from that Facility in forming the Portfolio Supply Curve for the Trading Interval,

if this quantity is greater than zero. The quantity declared must be in units of MWh;

(c) an Ancillary Service Declaration:

- i. a Market Participant which is a provider of Ancillary Services must declare:

1. the MWh quantity of energy from Non-Liquid Fuelled Facilities (as defined by the Fuel Declaration) that the Market Participant has not committed for inclusion in the Portfolio Supply Curve because it expects to have to maintain surplus capacity with which to provide Ancillary Services;
2. the MWh quantity of energy from Liquid Fuelled Facilities (as defined by the Fuel Declaration) that the Market Participant has not committed for inclusion in the Portfolio Supply Curve because it expects to have to maintain surplus capacity with which to provide Ancillary Services,

Chapter 6

where the sum of the quantities in 1 and 2 must equal the amount specified in clause 6.3A.2(e)(i) for that Market Participant;

(d) a Portfolio Supply Curve:

- i. one or more Price-Quantity Pairs may be specified;
- ii. the cumulative MWh quantity over all Price-Quantity Pairs must not exceed the greater of zero and:
 1. the Market Participant's Maximum Supply Capability as described in clause 6.3A.2(a); less
 2. the total MWh quantity specified by the Market Participant in its Availability Declaration; and
 3. the total MWh quantity specified by the Market Participant in its Ancillary Service Declaration as being unavailable; and

Points (i) and (ii) taken together mean that a Market Participant with no supply must issue a Portfolio Supply Curve having one step of zero quantity. The price is therefore arbitrary as it will not have any impact.

- iii. the cumulative MWh quantity over all Price-Quantity Pairs with prices exceeding the Maximum STEM Price must not exceed:
 1. the sum over all Facilities declared in the Fuel Declaration to be operating on Liquid Fuel of the MWh quantity specified in clause 6.3A.2(d); less
 2. the total MWh quantity specified by the Market Participant in its Availability Declaration as being unavailable from Facilities declared in its Fuel Declaration to be operating on Liquid Fuel; less
 3. the MWh quantity declared in its Ancillary Service Declaration as being unavailable from Liquid Fuelled Facilities;

(e) a Portfolio Demand Curve:

- i. one or more Price-Quantity Pairs may be specified; and
- ii. the cumulative quantity included in the Price-Quantity Pairs must not exceed the Market Participant's Maximum Consumption Quantity as described in clause 6.3A.2(b).

Points (i) and (ii) taken together mean that a Market Participant with no demand must still submit a Portfolio Demand Curve with zero quantity. That is, one Price-Quantity Pair must be provided but since the Maximum Consumption Quantity is zero the quantity must be zero.

6.6.3. [Blank]

Chapter 6

6.6.4. The maximum number of Price-Quantity Pairs which a Market Participant may include in a Portfolio Supply Curve is the greater of:

- (a) 10; and
- (b) the value of:
 - i. the limit on the cumulative MWh quantity over all Price-Quantity Pairs as defined in clause 6.6.2A(d)(ii);
 - ii. divided by 30 MW,rounded down to the nearest integer.

A participant with 100 MW of generation would be allowed 10 Price-Quantity Pairs in their Portfolio Supply Curve.

A participant with 1600 MW of generation would be allowed $1600/30 = 53$ Price-Quantity Pairs in their Portfolio Supply Curve.

6.6.5. For Price-Quantity Pairs in Portfolio Supply Curves:

- (a) each Price-Quantity Pair must comprise one price and one quantity;
- (b) each Price-Quantity Pair price must be:
 - i. in units of \$/MWh expressed to a precision of \$0.01/MWh;
 - ii. [Blank]
 - iiA. set such that:
 - 1. the sum of the Price-Quantity Pair quantities from Price-Quantity Pairs in the Portfolio Supply Curve with prices exceeding the Maximum STEM Price must not exceed the cumulative MWh quantity that the Market Participant can offer at the Alternative Maximum STEP Price, as defined in clause 6.6.2A(d)(iii)
 - 2. the prices for Price-Quantity Pair in the Portfolio Supply Curve to which 1 does not relate must not exceed the Maximum STEM Price;
 - iii. greater than or equal to the Minimum STEM Price;
 - iv. [Blank]
 - v. set such that no two Price-Quantity Pairs in a Portfolio Supply Curve have the same price;

The condition in v is required to avoid a situation where there would be more than one possible way of merging Portfolio Supply Curves and Portfolio Demand Curves into a single curve where there were multiple steps in one curve with the same price, and at least one step in the other curve with that price.

Chapter 6

- (c) each Price-Quantity Block quantity must be
 - i. in units of MWh expressed to a precision of 0.001 MWh;
 - ii. Loss Factor adjusted; and
- (d) a Price-Quantity Pair means that the Market Participant is prepared to sell a quantity of energy into the STEM for that Price-Quantity Pair equal to:
 - i. 0 MWh if the STEM Clearing Price is less than the Price-Quantity Pair price;
 - ii. the Price-Quantity Pair quantity if the STEM Clearing Price is greater than the Price-Quantity Pair price; and
 - iii. an amount between 0 MWh and the Price-Quantity Pair quantity if the STEM Clearing Price equals the Price-Quantity Pair price.

Clause (d) means that for any price we can define the quantity to be supplied from that Price-Quantity Pair. This definition makes it simple to describe in Appendix 6 how to combine the Portfolio Supply Curve and Portfolio Demand Curves.

6.6.6. [Blank]

6.6.7. The maximum number of Price-Quantity Pairs to be included in a Portfolio Demand Curve is to be the greater of:

- (a) 10; and
- (b) the integer value of:
 - i. the Market Participant's Maximum Consumption Capability as described in clause 6.3A.2(b);
 - ii. divided by 30 MW.

6.6.8. For Price-Quantity Pairs in Portfolio Demand Curves:

- (a) each Price-Quantity Pair price must be:
 - i. in units of \$/MWh expressed to a precision of \$0.01/MWh;
 - ii. less than or equal to the Alternative Maximum STEM Price;
 - iii. greater than or equal to the Minimum STEM Price; and
 - iv. set such that no two Price-Quantity Pairs in a Portfolio Demand Curve have the same price;

This last condition is required to avoid a situation where there would be more than one possible way of merging Portfolio Supply Curves and Portfolio Demand Curves into a single curve where there were multiple steps in one curve with the same price, and at least one step in the other curve with that price.

- (b) each Price-Quantity Pair quantity must be

Chapter 6

- i. in units of MWh expressed to a precision of 0.001 MWh;
 - ii. Loss Factor adjusted; and
- (c) a Price-Quantity Pair means that the Market Participant is prepared to buy a quantity of energy from the STEM for that Price-Quantity Pair equal to:
- i. 0 MWh if the STEM Clearing Price is greater than the Price-Quantity Pair price;
 - ii. the Price-Quantity Pair quantity if the STEM Clearing Price is less than the Price-Quantity Pair price; and
 - iii. an amount between 0 MWh and the Price-Quantity Pair quantity if the STEM Clearing Price equals the Price-Quantity Pair price.

Clause (c) means that for any price we can define the quantity to be supplied from that Price-Quantity Pair. This definition makes it simple to describe in Appendix 6 how to combine the Portfolio Supply Curve and Portfolio Demand Curves.

6.6.9. A Market Generator may apply to the IMO for all or part of the capacity of one of its Scheduled Generators that is not dual-fuel capable to be treated as if it was dual-fuel capable for the purposes of the STEM. The Market Generator must submit to the IMO an application in a form specified by the IMO, including supporting evidence of the relevant arrangements, and specifying the dates over which the application will apply.

The Market Generator can apply for non-dual fuel plant to be “deemed” dual-fuel capable, which will allow it to submit a greater proportion of its generation output at the Alternative Maximum STEM Price. The application must be done in advance, takes affect from the Scheduling Day following approval and stands until the relevant fuel contracts expire.

The type of arrangement contemplated is where a market participant may get another gas user to give up its gas usage for some period, which would then free up gas for the Market Participant’s regular supplier to supply as spot gas, but the Market Participant would then need to make a side payment to the other gas user, making the effective cost of the gas much higher.

6.6.10. The IMO must assess an application made under clause 6.6.9 and inform the Market Participant whether or not the application is approved. The IMO must approve the application only where the Market Participant provides evidence satisfactory to the IMO that:

- (a) the Market Participant has an arrangement with a user of fuel (“**Fuel User**”) to release a quantity of fuel for use in a Scheduled Generator which is not dual-fuel capable and is registered by the Market Participant;
- (b) the use of fuel released under the arrangement would result in the Fuel User using Liquid Fuel in a Facility or other equipment; and

Chapter 6

- (c) as a consequence of paragraphs (a) and (b), the short run marginal cost of generating electricity using the Scheduled Generator using fuel released under the arrangement would be above the Maximum STEM Price.

The IMO must approve the application only to the extent of the capacity associated with the quantity described in paragraph (a) and for the period of the arrangement referred to on paragraph (a).

6.6.11. Where the IMO approves an application under clause 6.6.9, the IMO must:

- (a) notify the Market Participant that the application has been approved as soon as practicable; and
- (b) update the relevant Standing Data in accordance with clause 2.34.

The Standing Data will be updated at the start of the next Scheduling Day.

6.6.12. When the IMO does not approve an application under clause 6.6.9, the IMO must notify the Market Participant as soon as practicable.

6.7. Format of Bilateral Submission Data

Because the energy provided by a generator may be the sum of its own generation plus energy it purchases under bilateral contract there will be NO process to verify that the quantity supplied by a party matches its physical capabilities. Instead, the IMO will just test that each submission balances.

If a submitting party makes an error in the numbers it submits, the IMO will not take any responsibility for this, and the issue must be resolved between the contracting parties.

6.7.1. A Market Generator submitting Bilateral Submission data or Standing Bilateral Submission data must include in the submission:

- (a) the identity of the Market Generator making the submission;
- (b) in the case of:
 - (i) Bilateral Submission data, the Trading Day to which the submission relates; and
 - (ii) Standing Bilateral Submission data, the day of the week to which the submission relates, where data provided for a day of the week relates to the Trading Day commencing on that day;

A Standing Bilateral Submission can be made for Monday through to Sunday, where data for the Trading Day commencing Tuesday will be used for Trading Days commencing on Tuesdays.

- (c) for each Trading Interval included in the submission:

Chapter 6

- i. the net quantity of energy to be sold by the submitting Market Generator;
 - ii. the identity of each Market Participant purchasing the energy covered by the Bilateral Submission;
 - iii. the net quantity of energy sold to each Market Participant identified in (ii); and
 - iv. the sum of the quantities in (i) and (iii) must be zero.
- (d) [Blank]

In the next clause we define positive numbers to be supply and negative numbers to be consumption. The submission contains quantities for the submitting Market Generator and the other participants it is selling to (or buying from). If Generator A is selling 20 MWh to Retailer B, this will be submitted as Generator A 20 MWh, Retailer B -20 MWh.

6.7.2. All quantities specified in a Bilateral Submission or a Standing Bilateral Submission:

- (a) must be in units of MWh;
- (b) must equal or exceed 0 MWh for net supply (that is, sold) by the relevant Market Participant;
- (c) must be less than 0 MWh for net consumption (that is, purchased) from relevant Market Participant;
- (d) must be expressed to a precision of 0.001 MWh; and
- (e) must be Loss Factor adjusted.

The following two clauses do not affect the validation of data provided during the course of submitting Bilateral Submission data. Clause 6.7.4 is included to discourage behaviour whereby a Market Generator over-estimates the load that it is supplying under a bilateral contract so as to displace supply by the Electricity Generation Corporation. See the comment following clause 2.16.2(hA) for further detail.

6.7.3. A Market Generator must not specify quantities in a Bilateral Submission or a Standing Bilateral Submission which exceed the quantity of energy that the Market Generator is contracted to supply to the relevant Market Customer.

6.7.4. A Market Customer must not significantly over-state its consumption as indicated by its Net Contract Position with a regularity that cannot be explained by a reasonable allowance for forecast uncertainty or the impact of Loss Factors.

6.8. [Blank]

The STEM Auction Process

6.9. The STEM Auction

- 6.9.1. The IMO must undertake the process described in this clause 6.9 for each Trading Interval in a Trading Day.
- 6.9.2. The Net Bilateral Position for Market Participant p in Trading Interval t is:
- (a) the sum of the quantities of energy referred to in clauses 6.7.1(c)(i) and 6.7.1(c)(iii) for the Market Participant in all Bilateral Submissions for Trading Interval t ; or
 - (b) zero if no Bilateral Submissions for Trading Interval t refer to the Market Participant.
- 6.9.3. Subject to clause 6.9.4, the IMO must determine STEM Offers and STEM Bids for each Market Participant for each Trading Interval in accordance with Appendix 6 using the valid STEM Submissions and Bilateral Submissions relating to that Trading Interval.
- 6.9.4. Where the IMO has recorded in accordance with clause 6.3B.8 that a Market Participant has not made a STEM Submission for a Trading Interval the IMO must not determine STEM Offers, STEM Bids or MCAP Price Curves for that Market Participant in that Trading Interval.
- 6.9.5. The IMO must determine an aggregate STEM bid curve for each Trading Interval from the STEM Bids where this aggregate STEM bid curve:
- (a) describes the quantity that Market Participants in aggregate wish to purchase from the IMO through the STEM at every price between, and including, the Minimum STEM Price and the Alternative Maximum STEM Price; and
 - (b) passes through the point indicating zero consumption at the Alternative Maximum STEM Price.

Chapter 6

The diagram shows an aggregate STEM bid curve.

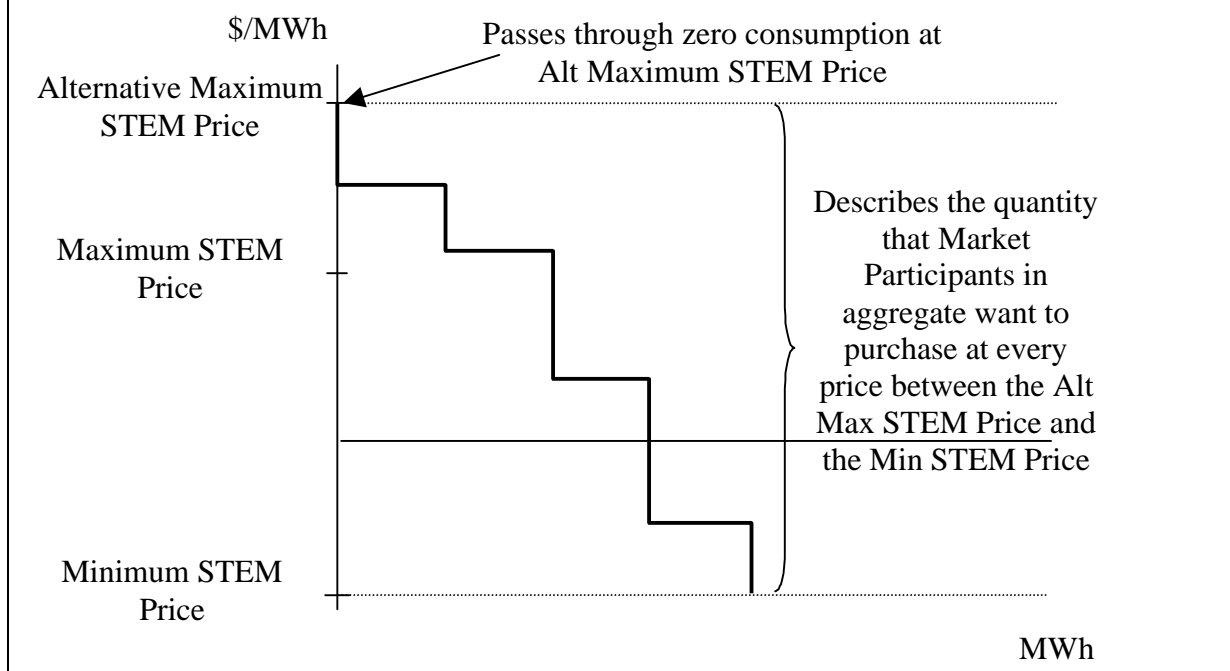

6.9.6. The IMO must determine an aggregate STEM offer curve for each Trading Interval from the STEM Offers where this aggregate STEM offer curve:

- describes the quantity that Market Participants in aggregate wish to sell to the IMO through the STEM at every price between, and including, the Minimum STEM Price and the Alternative Maximum STEM Price; and
- passes through the point indicating zero supply at the Minimum STEM Price.

These definitions ensure that both curves touch the price axis (at zero quantity) and both curves have quantities defined at every possible price. The result is that the aggregate curves will always cross.

6.9.7. The IMO will determine the STEM Clearing Price for a Trading Interval as the lowest price at which the STEM offer curve for a Trading Interval intersects the STEM bid curve for the Trading Interval.

6.9.8. The IMO will determine the STEM Clearing Quantity for a Trading Interval as the greatest quantity at which the STEM offer curve for the Trading Interval intersects the STEM bid curve for the Trading Interval.

That is, if the curves intersect at just one point, as will usually be the case, then the price and quantity is uniquely defined. However, if both intersect on a horizontal section of a conventional supply and demand curve, then there is a range of quantities that are valid given the price, so we will take the greatest quantity. Likewise, if they intersect on a vertical section, so that there is a range of prices that can be defined given the quantity, we will take the minimum price.

Chapter 6

Some diagrams illustrating STEM Auctions:

EXAMPLE 1

Where the aggregate STEM bid curve and aggregate STEM offer curve intersect sets the STEM Clearing Price and STEM Clearing Quantity.

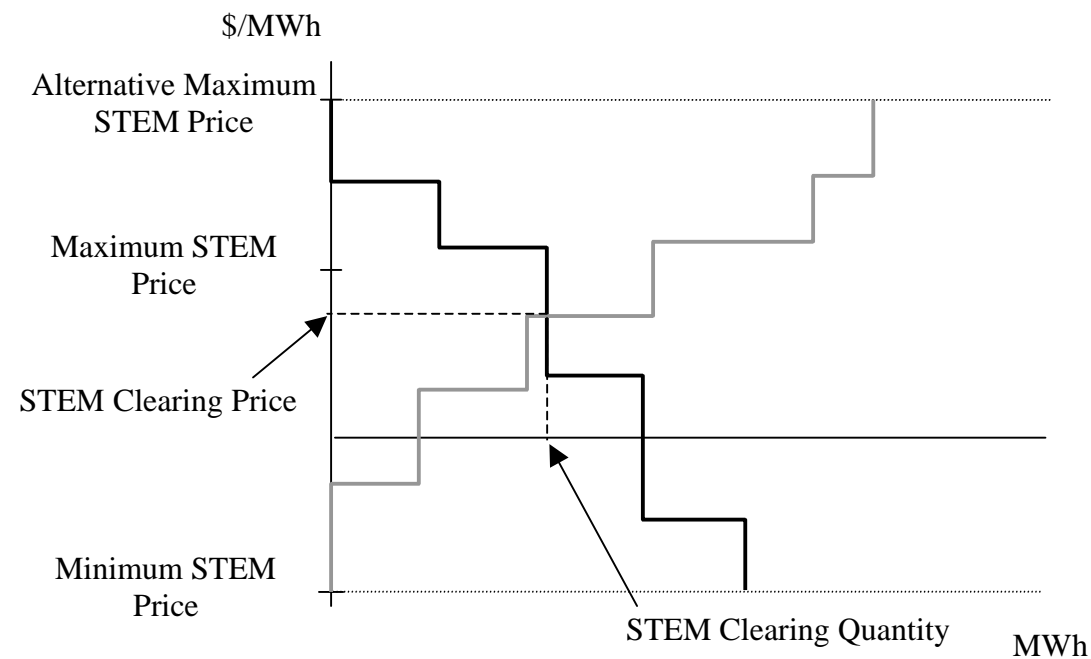

Chapter 6

EXAMPLE 2

The STEM Clearing Price is the lowest price at which the curves intersect, so if they intersect on a vertical section, the lowest point of intersection sets the price.

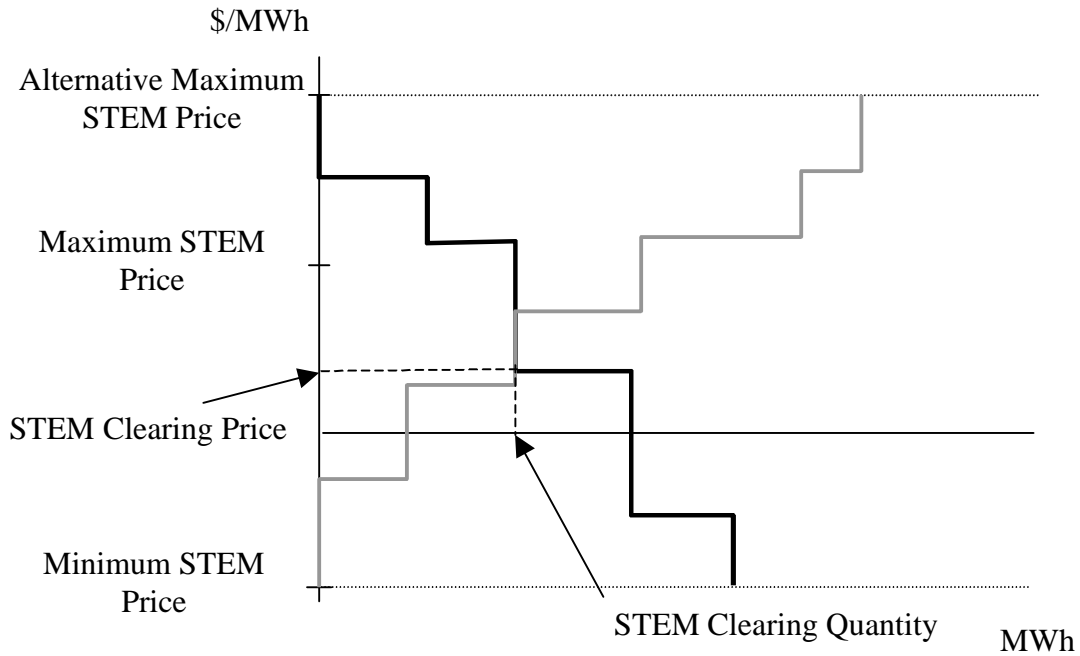

EXAMPLE 3

The STEM Clearing Price is the greatest quantity at which the curves intersect, so if they intersect on a horizontal section, the point of intersection with the greatest quantity sets the price.

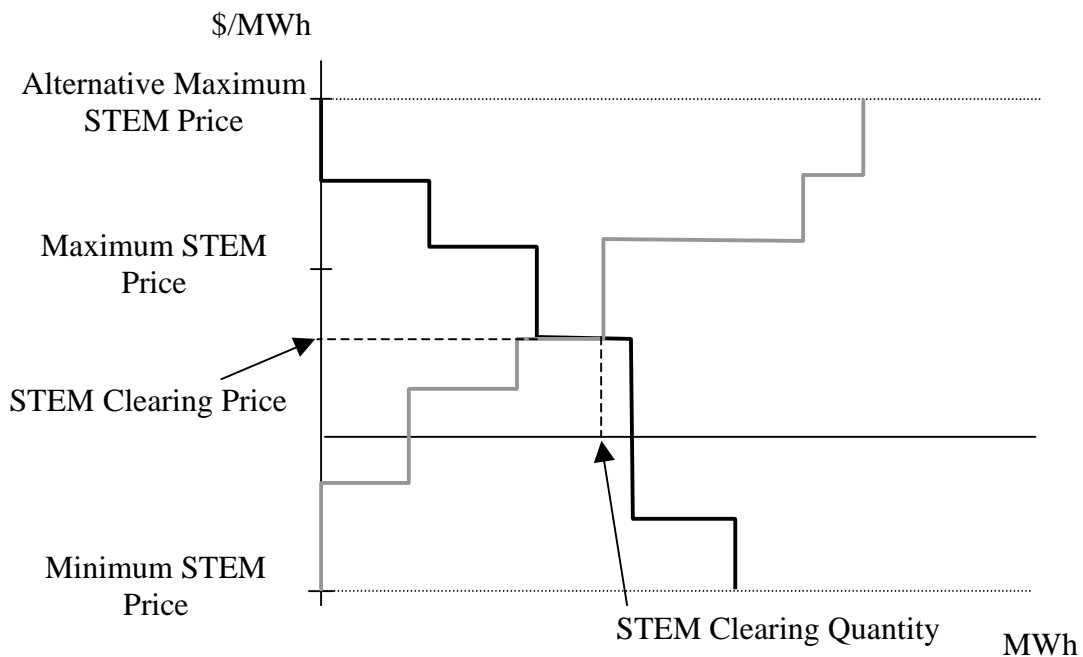

EXAMPLE 4

If no Portfolio Demand Curves are submitted, the IMO still generates STEM Offers and STEM Bids from the Portfolio Supply Curves and the Net Bilateral Positions.

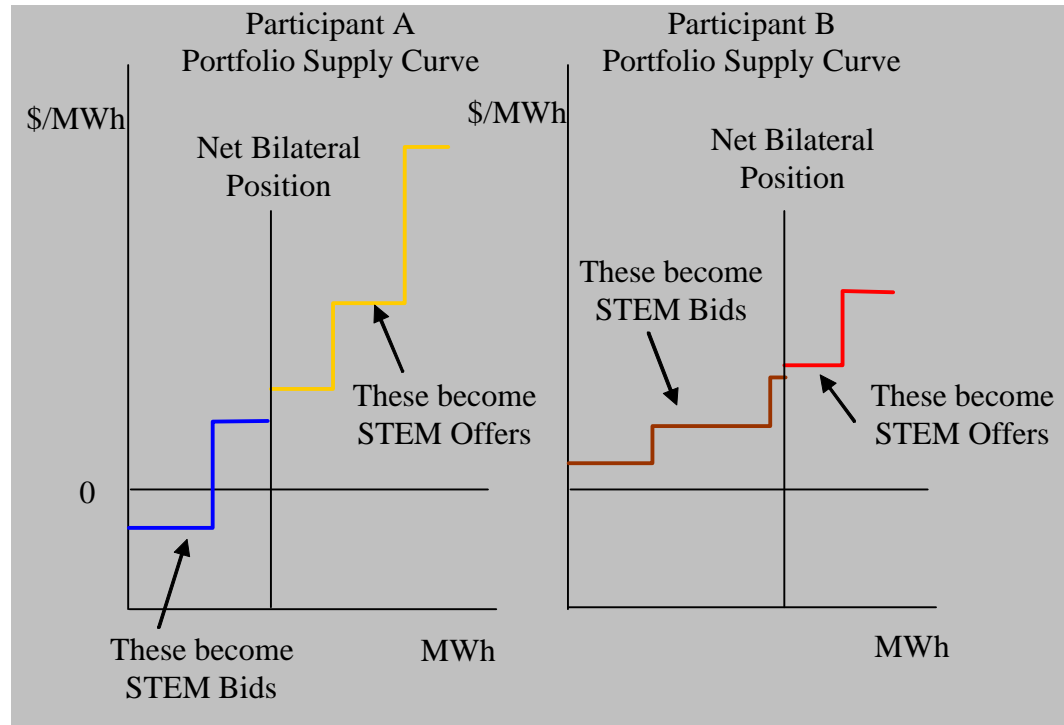

The IMO can clear the market using these generated STEM Offers and Bids. The diagram below shows the STEM being cleared.

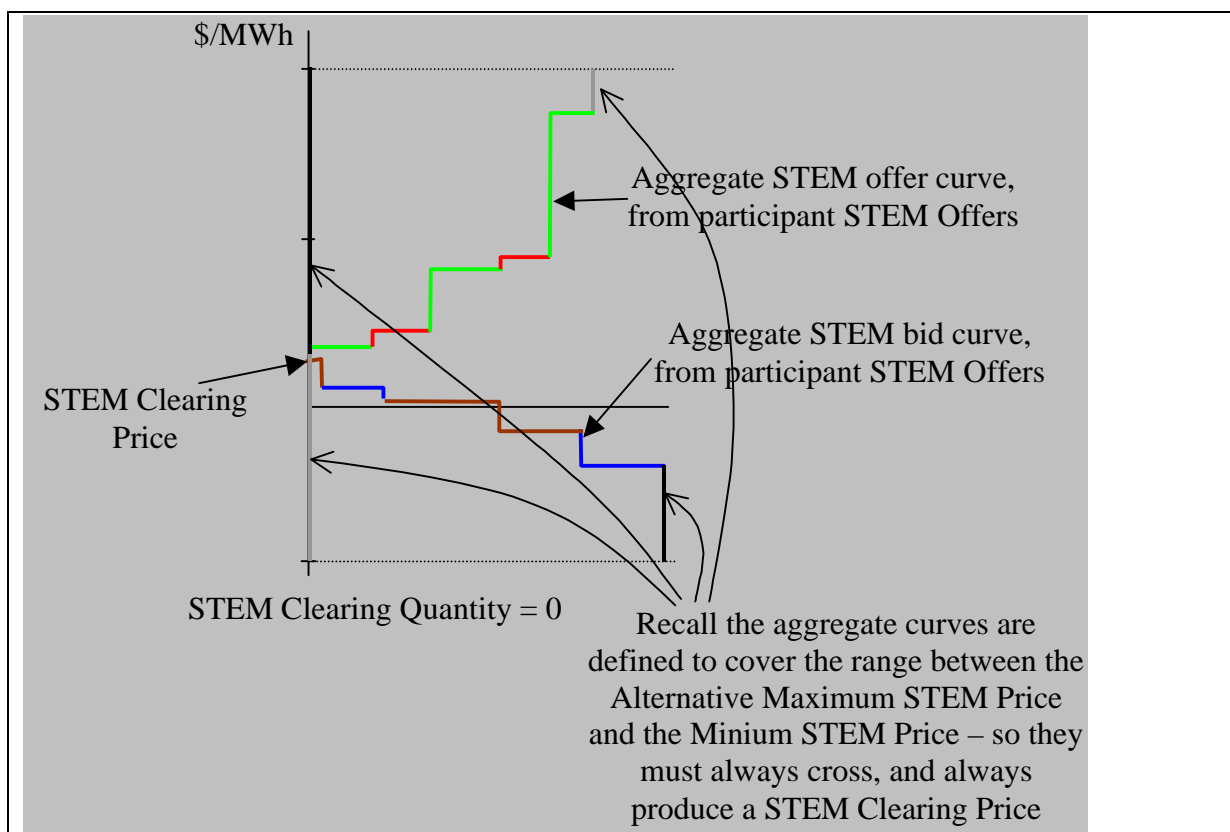

Even though no quantity has cleared, the STEM still produces a price that reflects the marginal cost of energy around the bilateral quantities – in this case the price a generator was willing to pay to reduce its generation below the level of its bilateral contract and instead supply the contract with energy purchased in the STEM (although no such energy was actually purchased).

6.9.9. All STEM Bid Price-Quantity Pairs for the Trading Interval with a price greater than the STEM Clearing Price for the Trading Interval must be scheduled by the IMO.

6.9.10. A STEM Bid Price-Quantity Pair with a price equal to the STEM Clearing Price for the Trading Interval must be scheduled by the IMO up to the Price-Quantity Pair quantity multiplied by:

- (a) the STEM Clearing Quantity less the total quantity for STEM Bid Price-Quantity Pairs scheduled by the IMO in accordance with clause 6.9.9; divided by
- (b) the total quantity for all STEM Bid Price-Quantity Pairs with a price equal to the STEM Clearing Price.

This calculates how much of the last bid curve step will clear and implements tie-breaking. Tie-breaking is in proportion to the size of the bid for each of the participants who bid at that price

Chapter 6

For example if Participant A bid 20 MWh at \$40, and Participant B bid 10 MWh at \$40, and the price is \$40, and 15MWh of the last step on the aggregate STEM bid curve is cleared, then:

Participant A will get cleared for $20 \times (15 / (20+10)) = 10$ MWh,

Participant B will get cleared for $10 \times (15 / (20+10)) = 5$ MWh.

6.9.11. All STEM Offer Price-Quantity Pairs for a Trading Interval with a price less than the STEM Clearing Price for the Trading Interval must be scheduled by the IMO.

6.9.12. A STEM Offer Price-Quantity Pair for a Trading Interval with a price equal to the STEM Clearing Price for the Trading Interval must be scheduled by the IMO up to the Price-Quantity Pair quantity multiplied by:

- (a) the STEM Clearing Quantity less the total quantity for STEM Offer Price-Quantity Pairs scheduled by the IMO in accordance with clause 6.9.11; divided by
- (b) the total quantity for all STEM Offer Price-Quantity Pairs with a price equal to the STEM Clearing Price.

6.9.13. The Net Contract Position for Market Participant p in Trading Interval t is:

- (a) the Net Bilateral Position for Market Participant p in Trading Interval t; plus,
- (b) the amount of energy purchased by the Market Participant from the IMO through the STEM at the STEM Clearing Price, which is the total quantity associated with Price-Quantity Pairs for Market Participant p scheduled by the IMO under clause 6.9.9 or 6.9.10 for Trading Interval t; minus
- (c) the amount of energy sold by the Market Participant to the IMO through the STEM at the STEM Clearing Price, which is the total quantity associated with Price-Quantity Pairs for Market Participant p scheduled by the IMO under clause 6.9.11 or 6.9.12 for Trading Interval t.

So if a participant has bilateral schedules to supply 100 MWh but purchased 50 MWh from the IMO in the STEM, their Net Contract Position would be to supply 50 MWh.

A positive value of the Net Contract Position indicates supply, a negative value indicates consumption.

6.10. Suspension of the STEM

6.10.1. The IMO must suspend the STEM auction for a Trading Interval if the IMO considers that it will not be in a position to undertake the process described in clause 6.9 and publish a valid STEM auction result under clauses 6.4.3(b), (c) and (d) for that Trading Interval by the time specified in clause 6.4.3.

Chapter 6

6.10.2. In the event that the STEM auction for a Trading Interval is suspended under clause 6.10.1, no Market Participant can purchase energy from or sell energy to the IMO through the STEM for that Trading Interval and no STEM Clearing Price is to be declared for that Trading Interval.

6.10.3. No compensation is due or payable to any Market Participant in the event that the STEM auction for a Trading Interval is suspended under clause 6.10.1.

The STEM would be suspended if the IMO is unable to produce a result, most likely because of IT problems. If we allowed an extension this would have a flow on effect as other parts of the market would be delayed.

Note that participants will not be penalised for their STEM related Reserve Capacity Obligations if the STEM is suspended. However they will still need to be ready to meet their obligations in dispatch.

Resource Plans and Balancing Data

6.11. Format of Resource Plans

6.11.1. A Market Participant submitting Resource Plan Submission data or Standing Resource Plan Submission data must include in the submission:

- (a) the identity of the Market Participant making the submission;
 - (aA) in the case of:
 - (i) Resource Plan Submission data, the Trading Day to which the submission relates; and
 - (ii) Standing Resource Plan Submission data, the day of the week to which the submission relates, where data provided for a day of the week relates to the Trading Day commencing on that day;

A Standing Resource Plan Submission can be made for Monday through to Sunday, where data for the Trading Day commencing Tuesday will be used for Trading Days commencing on Tuesdays.

- b) for each Scheduled Generator and Dispatchable Load registered by the Market Participant:
 - i. the name of the Facility;
 - ii. for a Scheduled Generator, the intended times of synchronisation and de-synchronisation, expressed to the nearest minute, during the Trading Day;
 - iii. the energy to be sent-out or consumed during each Trading Interval of the Trading Day included in the submission, where this amount:
 - 1. must be expressed in units of MWh;

Chapter 6

2. must be expressed to a precision of 0.001 MWh;
 3. must be zero if the Facility is expected not to operate during the Trading Interval; and
 4. must not exceed the expected capability of the Facility at that time, allowing for de-ratings and outages; and
- iv. the target megawatt output of each Facility at the end of each Trading Interval **included in the submission**;

These targets will provide System Management with a basis for issuing Dispatch Instructions.

- (c) for each Non-Scheduled Generator registered by the Market Participant:
- i. the name of the Facility;
 - ii. the expected energy to be sent-out during each Trading Interval of the Trading Day **included in the submission**, where this amount:
 1. must be expressed in units of MWh;
 2. must be expressed to a precision of 0.001 MWh; and
 3. must not exceed the expected capability of the Facility at that time, allowing for de-ratings and outages;
- (d) the total Loss Factor adjusted demand to be consumed by that Market Participant **for each Trading Interval** including demand associated with any Curtailable Load or Interruptible Load, but excluding demand associated with any Dispatchable Load; and

All other data required by the IMO and System Management, such as facility capacities and ramp rates, will be specified in standing data.

- (e) any shortfall **for each Trading Interval** between the net energy scheduled in the Resource Plan Submission and the Net Contract Position of the Market Participant.

Clause (e) is included to allow Market Participants to specify a Resource Plan that covers the required quantity even when they cannot physically do so. This allows the Resource Plan to be accepted and informs the IMO and System Management that a supply limitation exists. However, it does not excuse the submitter from the settlement obligations of the shortage.

6.11.2. For Resource Plan Submission **data or Standing Resource Plan Submission data** to be valid:

- (a) it must conform to the format specified in clause 6.11.1;
- (aA) 48 Trading Intervals of data must be submitted for each Trading Day;**

- (aB) no energy must be scheduled from a Facility that is a Scheduled Generator for any Trading Interval in which the Facility is not synchronised as indicated by the times specified in clause 6.11.1(b)(ii);
- (b) it must only include Facilities registered by the submitting Market Participant;
- (bA) it must not include a Scheduled Generator for any Trading Interval if that Scheduled Generator is under going a Commissioning Test during that Trading Interval;
- (c) it must not include Interruptible Loads or Curtailable Loads; and

Clause (c) has been added for clarity. To make the determination of Reserve Capacity Obligation compliance simpler, demand side options are automatically counted towards contributing to the Reserve Capacity Obligations without requiring them to be offered into the STEM. Consequently they cannot be individually identified in Resource Plans. However, this does not stop the operator from self-scheduling them as part of their general STEM demand bid. Further, the use of the Stipulated Default Load for measuring compliance of DSM sources (ie, when called demand must drop below some number of MWhs), means that self scheduling the resources does count as meeting the Reserve Capacity Obligations.

- (d) the net energy scheduled in the Resource Plan Submission data (or Resource Plan Submission data derived from Standing Resource Plan Submission data), after Loss Factor adjusting the Scheduled Generator, Non-Scheduled Generator, and Dispatchable Load energy, and taking into account shortfalls indicated in accordance with clause 6.11.1(e), for each Trading Interval included in the submission must equal the Net Contract Position of the Market Participant for that Trading Interval.

The test described in (d) is not applied to Standing Resource Plan Submissions at the time they are submitted.

6.11A. Format of Balancing Data

The Balancing Data allows a market participant to specify different pay-as-bid balancing prices for a day (for changes in energy schedules). Commitment cost data and compensation for decreasing the output of non-scheduled generators are not included in Balancing Data (but can be changed via the normal standing data change process).

6.11A.1. A Market Participant submitting Balancing Data Submission data must include in the submission:

- (a) the identity of the Market Participant making the submission;
- (b) for each Scheduled Generator registered by the Market Participant:
 - i. the name of the Facility;
 - ii. if the Facility is registered as being capable of running on Non-Liquid Fuel, the following prices to apply for the Trading Day:

1. a Non-Liquid Supply Increase Price for Peak Trading Intervals;
 2. a Non-Liquid Supply Decrease Price for Peak Trading Intervals, where this price must be not greater than that in (1);
 3. a Non-Liquid Supply Increase Price for Off-Peak Trading Intervals; and
 4. a Non-Liquid Supply Decrease Price for Off-Peak Trading Intervals, where this price must be not greater than that in (3),
where these prices must be not less than the Minimum STEM Price, not more than the Maximum STEM Price, and must be expressed in units of \$/MWh to a precision of \$0.01/MWh; and
- iii. if the Facility is registered as being capable of running on Liquid Fuel, the following prices to apply for the Trading Day:
1. a Liquid Supply Increase Price for Peak Trading Intervals;
 2. a Liquid Supply Decrease Price for Peak Trading Intervals, , where this price must be not greater than that in (1);
 3. a Liquid Supply Increase Price for Off-Peak Trading Intervals; and
 4. a Liquid Supply Decrease Price for Off-Peak Trading Intervals, where this price must be not greater than that in (3),
where these prices must be not less than the Minimum STEM Price, not more than the Alternative Maximum STEM Price, and must be expressed in units of \$/MWh to a precision of \$0.01/MWh;
- (c) for each Dispatchable Load registered by the Market Participant:
- i. the name of the Facility;
 - ii. the following prices to apply for the Trading Day:
 1. a Consumption Increase Price for Peak Trading Intervals;
 2. a Consumption Decrease Price for Peak Trading Intervals, where this price must be not less than that in (1);
 3. a Consumption Increase Price for Off-Peak Trading Intervals; and
 4. a Consumption Decrease Price for Off-Peak Trading Intervals, where this price must be not less than that in (3),
where these prices must be not less than the Minimum STEM Price, not more than the Alternative Maximum STEM Price, and must be expressed in units of \$/MWh to a precision of \$0.01/MWh; and
- (d) for each Curtailable Load registered by the Market Participant:
- i. the name of the Facility;

- ii. the following prices to apply for the Trading Day:
 1. A Consumption Decrease Price for Peak Trading Intervals;
 2. A Consumption Decrease Price for Off-Peak Trading Intervals,where these prices must be not less than the Minimum STEM Price, not more than the Alternative Maximum STEM Price, and must be expressed in units of \$/MWh to a precision of \$0.01/MWh.

6.11A.2. For Balancing Data Submission data to be valid:

- (a) it must conform to the format specified in clause 6.11A.1; and
- (b) it must only include Facilities registered by the submitting Market Participant.

The Dispatch Merit Order

6.12. The Dispatch Merit Order

The Dispatch Merit Orders are used to decide the order in which to call Non-Electricity Generation Corporation Scheduled Generators if it is necessary for System Management to issue dispatch instructions.

The IMO calculates the Dispatch Merit Orders daily using the applicable Balancing Data and standing data prices listed in Appendix 1 (for decommitment costs and non-scheduled facilities), and provides the Dispatch Merit Orders and the Market Participant Fuel Declarations to System Management in accordance with clause 7.5.

Note that if a substantial number of Curtailable Loads are receiving Reserve Capacity payments, and so can be called on by System Management, it may be necessary to add an additional Dispatch Merit Order dealing with the order in which System Management calls on Curtailable Loads.

6.12.1.

- (a) By 1:30 PM on the Scheduling Day, the IMO must determine the Dispatch Merit Orders identified in paragraphs (b) to (g). A Dispatch Merit Order lists the order in which the Scheduled Generators and Dispatchable Loads of Market Participants other than the Electricity Generation Corporation will, in the absence of transmission limitations or limitations necessary to maintain Power System Security, be issued Dispatch Instructions to increase or decrease output.
- (b) A Dispatch Merit Order for an increase in generation or decrease in consumption relative to the quantities included in the applicable Resource Plan (or the current operating level of a Facility not included in a Resource Plan) during Peak Trading Intervals. The IMO must take into account the following principles when determining this Dispatch Merit Order:

- i. this Dispatch Merit Order must list all Scheduled Generators, Curtailable Loads and Dispatchable Loads registered by Market Participants other than **the Electricity Generation Corporation**;
 - ii. this Dispatch Merit Order must be determined applying the Market Participant Balancing Data applicable to the Trading Day by ranking the Registered Facilities referred to in (i) in increasing order of the:
 1. Non-Liquid Supply Increase Price for Peak Trading Intervals;
 2. Liquid Supply Increase Price for Peak Trading Intervals; or
 3. Consumption Decrease Price for Peak Trading Intervals, as applicable;
 - iii. dual fuelled Facilities must appear in the position determined by the prices referred to in paragraph (ii) when the Facility is not running on Liquid Fuel and again in the position determined by those prices when the Facility is running on Liquid Fuel; and
 - iv. Liquid Fuelled Facilities, including dual fuelled Facilities running on Liquid Fuel, must be indicated with a flag.
- (c) A Dispatch Merit Order for a decrease in generation or increase in consumption relative to the quantities included in the applicable Resource Plan (or the current operating level of a Facility not included in a Resource Plan) during Peak Trading Intervals. The IMO must take into account the following principles when determining this Dispatch Merit Order:
- i. this Dispatch Merit Order must list all Scheduled Generators, Non-Scheduled Generators and Dispatchable Loads registered by Market Participants other than **the Electricity Generation Corporation**;
 - ii. this Dispatch Merit Order must be determined applying the Market Participant Balancing Data applicable to the Trading Day by ranking the Registered Facilities referred to in paragraph (i) in decreasing order of the:
 1. Non-Liquid Supply Decrease Price for Peak Trading Intervals;
 2. Liquid Supply Decrease Price for Peak Trading Intervals; or
 3. Consumption Increase Price for Peak Trading Intervals, as applicable.
 - iii. dual fuelled Facilities must appear in the position determined by the prices referred to in paragraph (ii) when the Facility is not running on Liquid Fuel and again in the position determined by those prices when the Facility is running on Liquid Fuel; and
 - iv. Liquid Fuelled Facilities, including dual fuelled Facilities running on Liquid Fuel, must be indicated with a flag;

Chapter 6

- (d) A Dispatch Merit Order for decommitment of Scheduled Generators relative to the unit commitment indicated by the applicable Resource Plan during Peak Trading Intervals. The IMO must take into account the following principles when determining this Dispatch Merit Order:
- i. this Dispatch Merit Order must list all Scheduled Generators registered by Market Participants other than the Electricity Generation Corporation;
 - ii. this Dispatch Merit Order must be determined applying the Standing Data described in Appendix 1(c)(i)(2) by ranking the Registered Facilities referred to in paragraph (i) in increasing order of the dollar amount paid to the Market Participant for a decommitment of the Facility.

Note that since there is only one decommitment price, the peak and off-peak Dispatch Merit Orders for decommitment will be identical.

- (e) A Dispatch Merit Order for an increase in generation or decrease in consumption relative to quantities included in the applicable Resource Plan (or the current operating level of a Facility not included in a Resource Plan) during Off-peak Trading Intervals. The IMO must take into account the following principles when determining this Dispatch Merit Order:
- i. this Dispatch Merit Order must list all Scheduled Generators, Curtailable Loads and Dispatchable Loads registered by Market Participants other than the Electricity Generation Corporation;
 - ii. this Dispatch Merit Order must be determined applying the Market Participant Balancing Data applicable to the Trading Day by ranking the Registered Facilities referred to in paragraph (i) in increasing order of the:
 1. Non-Liquid Supply Increase Price for Off-Peak Trading Intervals;
 2. Liquid Supply Increase Price for Off-Peak Trading Intervals; or
 3. Consumption Decrease Price for Off-Peak Trading Intervals, as applicable;
 - iii. dual fuelled facilities must appear in the position determined by the prices referred to in paragraph (ii) when the Facility is not running on Liquid Fuel and again in a position determined by those prices when the Facility is running on Liquid Fuel; and
 - iv. Liquid Fuelled Facilities, including dual fuelled Facilities running on Liquid Fuel, must be indicated with a flag.
- (f) A Dispatch Merit Order for a decrease in generation or increase in consumption relative to the quantities included in the applicable Resource

Plan (or zero where the quantity was not included in a Resource Plan Submission) during Off-peak Trading Intervals. The IMO must take into account the following principles when determining this Dispatch Merit Order:

- i. this Dispatch Merit Order must list all Scheduled Generators, Non-Scheduled Generators and Dispatchable Loads registered by Market Participants other than the Electricity Generation Corporation;
 - ii. this Dispatch Merit Order must be determined applying the Market Participant Balancing Data applicable to the Trading Day by ranking the Registered Facilities referred to in paragraph (i) in decreasing order of the:
 1. Non-Liquid Supply Decrease Price for Off-Peak Trading Intervals;
 2. Liquid Supply Decrease Price for Off-Peak Trading Intervals; or
 3. Consumption Increase Price for Off-Peak Trading Intervals; as applicable.
 - iii. dual fuelled Facilities must appear in the position determined by the prices referred to in paragraph (ii) when the Facility is not running on Liquid Fuel and again in a position determined by those prices when the Facility is running on Liquid Fuel; and
 - iv. Liquid Fuelled Facilities, including dual fuelled Facilities running on Liquid Fuel, must be indicated with a flag.
- (g) A Dispatch Merit Order for decommitment of Scheduled Generators relative to the unit commitment indicated by the applicable Resource Plan during Off-Peak Trading Intervals. The IMO must take into account the following principles when determining this Dispatch Merit Order:
- i. this Dispatch Merit Order must list all Scheduled Generators registered by Market Participants other than the Electricity Generation Corporation;
 - ii. this Dispatch Merit Order must be determined applying the Standing Data described in Appendix 1(c)(i)(2) by ranking the Registered Facilities referred to in paragraph (i) in increasing order of the dollar amount paid to the Market Participant for a decommitment of the Facility during Off-Peak Trading Intervals.

Note that since there is only one decommitment price, the peak and off-peak Dispatch Merit Orders for decommitment will be identical.

- (h) Where the prices in Balancing Data or payments described in Standing Data, as applicable, for two or more Market Participants are equal, then for the purpose of determining the ranking in any Dispatch Merit Order other than

those for decommitment, the IMO must rank a Registered Facility with a greater sent out capacity registered in Standing Data before a Registered Facility with a lesser sent out capacity. For a Dispatch Merit Order for decommitment, the IMO must rank a Registered Facility with a greater name plate capacity registered in Standing Data before a Registered Facility with a lesser name plate capacity.

Given that dispatch instructions for energy will be for capacity available to the market, it is appropriate that ties be broken based on sent out capacity. However, for decommitment, it is more appropriate to break ties based on name plate capacity.

Balancing Pricing and Quantities

6.13. Real Time Dispatch Information

6.13.1. System Management must provide the IMO with dispatch data for settlement purposes in accordance with clause 7.13.

6.14. Calculation of MCAP, UDAP and DDAP

6.14.1. By 3 PM on the first Business Day following the end of a Trading Day, the IMO must calculate and publish for each Trading Interval on the Trading Day:

- (a) the Marginal Cost Administered Price (MCAP);
- (b) the Upwards Deviation Administered Price (UDAP); and
- (c) the Downwards Deviation Administered Price (DDAP),

in accordance with this clause 6.14.

6.14.2. The value of MCAP for a Trading Interval is calculated as follows:

- (a) If the STEM Auction was suspended for the Trading Interval under clause 6.10.1, and the process described in clause 6.9 cannot subsequently be completed by the time MCAP must be published under clause 6.14.1, the IMO must determine MCAP for the Trading Interval to be the value of MCAP for the equivalent Trading Interval on the most recent Trading Day in the past which commenced on the same day of the week, and was or was not a public holiday, as applicable.
- (b) If the STEM Auction was not suspended for the Trading Interval under clause 6.10.1, or was suspended but the process described in clause 6.9 can subsequently be completed for the purposes of this clause by the time MCAP must be published under clause 6.14.1, then:
 - i. If any of the following circumstances apply, then MCAP must be calculated in accordance with clause 6.14.3:

1. [Blank]

Chapter 6

2. the Relevant Quantity for the Trading Interval is not between 95% and 105% of the Scheduled System Load for that Trading Interval.
 3. [Blank]
 4. [Blank]
- ii. If paragraph (i) does not apply then MCAP equals the STEM Clearing Price for that Trading Interval.

6.14.3. Where MCAP is to be calculated in accordance with this clause under clause 6.14.2(b)(i):

- (a) subject to clause 6.9.4 the IMO must determine MCAP Price Curves for each Market Generator for the relevant Trading Interval in accordance with Appendix 6 using the valid STEM Submissions and Bilateral Submissions relating to that Trading Interval;
- (b) the IMO must determine an Aggregate MCAP Price Curve for each Trading Interval from the MCAP Price Curves determined in accordance with paragraph (a) where this Aggregate MCAP Price Curve:
 - (i) describes the quantity included in the MCAP Price Curves for all Market Generators at every price between, and including, the Minimum STEM Price and the Alternative Maximum STEM Price; and
 - (ii) passes through the point indicating zero supply at the Minimum STEM Price.
- (c) the IMO will determine MCAP as:
 - (i) the Alternative Maximum STEM Price, where the Relevant Quantity determined according to clause 6.14.4 exceeds the total quantity in the Aggregate MCAP Price Curve; and otherwise
 - (ii) the lowest price applying for the Relevant Quantity determined according to clause 6.14.4 on the Aggregate MCAP Price Curve.

6.14.4. For the purposes of clauses 6.14.2 and 6.14.3:

- (a) the "Operational System Load Estimate" for a Trading Interval is the estimate that the IMO receives from System Management of the total Loss Factor adjusted MWh consumption supplied via the SWIS during that Trading Interval. This estimate equals the total loss adjusted generator sent out energy as estimated from generator operational meter data and the use of state estimator systems;
- (b) the "Resource Plan Load" for a Trading Interval is total consumption as specified in applicable Resource Plans relating to that Trading Interval, including for Interruptible Loads, Curtailable Loads, Dispatchable Loads and Non-Dispatchable Loads; and

Chapter 6

- (c) the “Scheduled System Load” for a Trading Interval is the **sum of**:
- i. **the sum over all Resource Plans for that Trading Interval of the total Loss Factor adjusted generation scheduled in each Resource Plan;**
 - ii. **the sum over all Resource Plans of the shortfall quantity for that Trading Interval as described in clause 6.11.1(e); and**
 - iii. **the Net Contract Position of the Electricity Generation Corporation for that Trading Interval.**
- (d) the “Relevant Quantity” equals:
- i. the Operational System Load Estimate for the Trading Interval; plus
 - ii. IMO’s estimate of the total MWh demand curtailed during that Trading Interval (if any); plus
 - iii. the IMO’s estimate of the amount by which energy provided by Market Generators other than **the Electricity Generation Corporation** falls short of the relevant Resource Plan quantities.

6.14.5. The value of UDAP for a Trading Interval equals:

- (a) $0.5 \times \text{MCAP}$ during Peak Trading Intervals; and
- (b) zero during Off-Peak Trading Intervals.

6.14.6. The value of DDAP for a Trading Interval equals the lesser of:

- (a) the Alternative Maximum STEM Price; and
- (b) the greater of:
 - i. the Minimum STEM Price; and
 - ii. the price that is:
 1. $1.3 \times \text{MCAP}$ for Peak Trading Intervals; and
 2. $1.1 \times \text{MCAP}$ for Off-peak Trading Intervals.

6.15. The Dispatch Schedule

The references to clause 4.25.10 and 3.21A.14 in the following clause relate to scheduled generators subject to Commissioning Trials or Reserve Capacity testing.

6.15.1. For a Market Participant other than **the Electricity Generation Corporation**, the Dispatch Schedule for a Trading Interval for a Scheduled Generator (excluding those to which clauses 3.21A.14 or 4.25.10 apply) or Dispatchable Load is:

- (a) where no Dispatch Instructions were issued in respect of the Registered Facility for the Trading Interval, equal to the energy to be generated and sent out or consumed by the Registered Facility indicated in the applicable Resource Plan for that Trading Interval; or

Chapter 6

- (b) where one or more Dispatch Instructions that specified a target MW output level were issued to the Market Participant in respect of the Registered Facility for the Trading Interval, equal to:
- i. where:
 1. the Metered Schedule plus the Facility's Facility Dispatch Tolerance is greater than or equal to the amount calculated in accordance with Appendix 7; and
 2. the Metered Schedule less the Facility's Facility Dispatch Tolerance is less than or equal to the amount calculated in accordance with Appendix 7;then the Metered Schedule; or
 - ii. otherwise, the amount calculated in accordance with Appendix 7.

So if the Metered Schedule is within plus or minus the tolerance of the calculated Dispatch Schedule amount, the Dispatch Schedule is reset to equal the Metered Schedule – i.e. the Market Participant is deemed to have complied.

6.15.2. The Dispatch Schedule for a Trading Interval for any of the following Facilities equals the corresponding Metered Schedule:

- (a) a Non-Scheduled Generator;
- (aA) a Scheduled Generator to which clauses 3.21A.14 or 4.25.10 apply;
- (b) a Non-Dispatchable Load;
- (c) a Curtailable Load;
- (d) an Interruptible Load;
- (e) a Scheduled Generator or Dispatchable Load registered by the Electricity Generation Corporation; and
- (f) a Scheduled Generator or Dispatchable Load registered by a Market Participant (other than the Electricity Generation Corporation) where a Dispatch Instruction of the type described in clause 7.7.3(d)(ii) was issued to the Market Participant in respect of the Facility.

The last clause relates to Dispatch instructions where the Metered Schedule is to be used because System Management did not specify a precise MW target but a dispatch instruction is considered to have been issued (e.g. for automatic reserve activation)

6.16. The Metered Schedule

6.16.1. The Metered Schedule for a Trading Interval for a Facility or Non-Dispatchable Load is determined by IMO in accordance with clause 9.3.3.

A positive value represents supply and a negative value represents consumption.

Note that not all non-dispatchable load will be interval metered, so that some of the data received in the meter data submission will relate to Notional Wholesale Meters as described in the Wholesale Market Metering Chapter.

6.17. Balancing Settlement Quantities

6.17.1. The IMO must determine for each Market Participant and each Trading Interval of each Trading Day:

- (a) the Authorised Deviation Quantity;
- (b) the Upward Unauthorised Deviation Quantity;
- (c) the Downward Unauthorised Deviation Quantity;
- (d) the Resource Plan Deviation Quantity; and
- (e) the Dispatch Instruction Payment,

in accordance with this clause 6.17.

The following diagram illustrates how balancing settlement works. The Authorised Deviation Quantity is based on the difference between the Net Dispatch Schedule Position and the Net Contract Position, and is settled at MCAP. In the case shown, the participant's net supply has decreased (generation down or demand up) so it pays MCAP. Note that the Facility Dispatch Tolerance is applied to the Dispatch Schedule of Scheduled Generators and Dispatchable Loads, so that if their Metered Schedule is within the tolerance, their Dispatch Schedule is set to equal the Metered Schedule.

Two possible metering solutions are shown. For Net Metered Schedule 1, the participant has supplied more energy than is required and assuming that this is more than the tolerance, this is an Upward Unauthorised Deviation Quantity, and is paid UDAP for supply above the dispatch schedule. If the difference in energy had been less than the Facility Dispatch Tolerance, no Upward Unauthorised Deviation Quantity results.

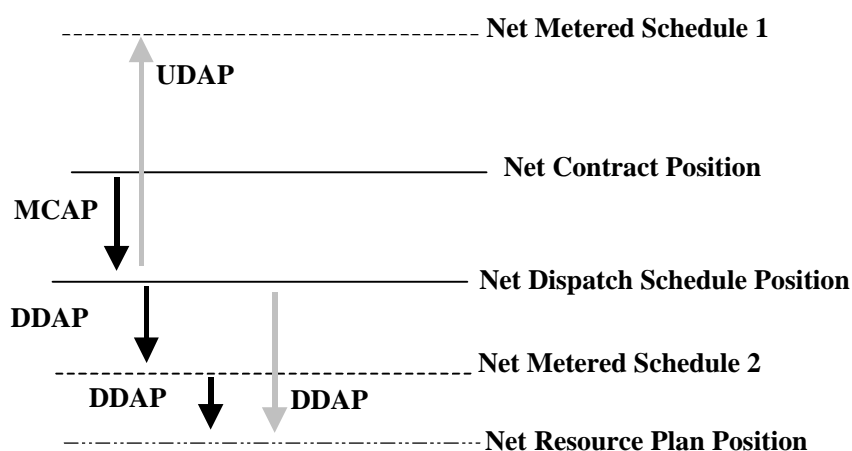

Chapter 6

For Net Metered Schedule 2, the Participant has supplied less than is required, i.e. it is a Downward Unauthorised Deviation Quantity, and is charged DDAP, which exceeds MCAP, again assuming that the deviation exceeded the Facility Dispatch Tolerance. Note that the Downward Unauthorised Deviation Quantity is defined as a negative quantity.

The Net Resource Plan Position represents how much energy is supplied under the Resource Plan for Market Participants other than **the Electricity Generation Corporation**. The Resource Plan Deviation Quantity charge only applies when the Net Resource Plan Position is lower than the other schedules. The logic is that if the participant is unable to cover its contract position with its Resource Plan then that should be treated the same as failing to cover a contract position or a Dispatch Instruction after submitting a Resource Plan that covered its contract position. If we did not have this charge then Market Participants could deliberately fall short of their contract position in their Resource Plans, not get penalised by Downward Unauthorised Deviation Quantity (since this is assessed against the Resource Plan) and yet get pay-as-bid based payments when called upon in real-time. The Resource Plan Deviation Quantity is defined as a negative quantity.

6.17.2. The Authorised Deviation Quantity, $ADQ(p,d,t)$, for Market Participant p and Trading Interval t of Trading Day d equals:

- (a) the net sum of all the Dispatch Schedules for Trading Interval t for the Registered Facilities registered by Market Participant p and Non-Dispatchable Loads associated with Market Participant p as indicated in Standing Data,
- (b) less, the Net Contract Position of Market Participant p in Trading Interval t ;
- (c) less, the sum over all of Market Participant p 's Facilities of the Balancing Support Contract energy dispatched from them in Trading Interval t as specified by System Management in accordance with clause 7.13(dA);

This describes the deviation of a Market Participant's energy position from its net bilateral contract position assuming it followed all dispatch instructions. **Energy dispatched under Balancing Support Contracts will appear in the Dispatch Schedules in (a) so must be subtracted in (c) to ensure that no additional payment is made for this energy than that allowed under the Balancing Support Contract.** The quantity calculated in 6.17.2 is settled at MCAP, although additional payments are also made in clause 6.17.6 where a Market Participant other than **the Electricity Generation Corporation** has received Dispatch Instructions which have the effect of making the Dispatch Instructions "pay as bid".

6.17.3. The Upward Unauthorised Deviation Quantity, $UUDQ(p,d,t)$, for Market Participant p and Trading Interval t of Trading Day d equals the sum over all that Market Participant's Registered Facilities, other than those to which clauses 3.21A.14 or 4.25.10 apply, of the greater of:

- (a) the quantity that is:
 - i. the Facility's Metered Schedule for Trading Interval t ; less
 - ii. the Facility's Dispatch Schedule for Trading Interval t ; and

Chapter 6

- (b) zero.

Note that the Metered Schedule equals the Dispatch Schedule for all facilities except Scheduled Generators and Dispatchable Loads registered to Market Participants other than the Electricity Generation Corporation. Also the metered and dispatch quantities are positive for supply and negative for consumption. UUDQ is settled at UDAP. The reference to clauses 3.21A.14 and 4.25.10 exempts Facilities subject to Commissioning Tests and Reserve Capacity tests from exposure to UDAP.

6.17.4. The Downward Unauthorised Deviation Quantity, $DUDQ(p,d,t)$, for Market Participant p and Trading Interval t of Trading Day d equals the sum over all that Market Participant's Registered Facilities, other than those to which clauses 3.21A.14 or 4.25.10 apply, of the lesser of:

- (a) the quantity that is:
- i. the Facility's Metered Schedule for Trading Interval t ; less
 - ii. the Facility's Dispatch Schedule for Trading Interval t ; and
- (b) zero.

Note that the Metered Schedule equals the Dispatch Schedule for all facilities except Scheduled Generators and Dispatchable Loads registered to Market Participants other than the Electricity Generation Corporation. DUDQ is settled at DDAP. The reference to clauses 3.21A.14 and 4.25.10 exempts Facilities subject to Commissioning Tests and Reserve Capacity tests from exposure to DDAP.

6.17.5. The Resource Plan Deviation Quantity, $RPDQ(p,d,t)$, for Market Participant p and Trading Interval t of Trading Day d equals:

- (a) if Market Participant p is the Electricity Generation Corporation, zero; and
- (b) otherwise, the lesser of zero and:
- i. the Net Contract Position of Market Participant p for Trading Interval t , less the shortfall quantity specified in clause 6.11.1(e) less:
 - ii. the lesser of:
 1. the Net Contract Position of Market Participant p for Trading Interval t ;
 2. the net sum of all the Metered Schedules for Trading Interval t for the Registered Facilities and Non-Dispatchable Loads registered by Market Participant p ; and
 3. the net sum of all the Dispatch Schedules for Trading Interval t for the Registered Facilities and Non-Dispatchable Loads registered by Market Participant p .

This is settled at DDAP.

Chapter 6

6.17.6. The Dispatch Instruction Payment, DIP(p,d,t), for Market Participant p and Trading Interval t of Trading Day d equals:

- (a) zero, if Market Participant p:
 - i. is the Electricity Generation Corporation; or
 - ii. was issued no Dispatch Instructions or was issued instructions described by either (c) or (d) for the Trading Interval;
- (b) otherwise, the sum over all Scheduled Generators and Dispatchable Loads registered by the Market Participant of the following amounts for Trading Interval t:
 - i. if the Dispatch Schedule for the Registered Facility is equal to the quantity indicated in the applicable Resource Plan for the Registered Facility for Trading Interval t and the Balancing Support Contract energy dispatched from the Facility in Trading Interval t as specified by System Management in accordance with clause 7.13(dA) is zero, the amount for the Registered Facility is zero;
 - ii. if paragraph (i) does not apply, the amount for the Registered Facility is the product of:
 1. the qualifying quantity for Trading Interval t as calculated in accordance with clause 6.17.8, less the sum of the quantity indicated in the applicable Resource Plan for the Registered Facility for Trading Interval t and the Balancing Support Contract energy dispatched from the Facility in Trading Interval t as specified by System Management in accordance with clause 7.13(dA); and
 2. the applicable price as defined by clause 6.17.7 less MCAP for Trading Interval t.
- (c) plus the sum over all Non-Scheduled Generators registered by the Market Participant of the amount that is the product of:
 - i. the quantity by which the Non-Scheduled Generator was instructed by System Management to reduce its output; and
 - ii. the Standing Data price defined in Appendix 1(e)(v) that was current at the time of the Trading Interval for the Non-Scheduled Generator for a decrease in generation, (accounting for whether the Trading Interval is a Peak Trading Interval or an Off-Peak Trading Interval);
- (d) plus the sum over all Curtailable Loads registered by the Market Participant of the amount that is the product of:
 - i. the quantity by which the Curtailable Load was instructed by System Management to reduce its consumption; and

- ii. the price defined in clause 6.11A.1(d)(ii) that was current at the time of the Trading Interval for the Curtailable Load (accounting for whether the Trading Interval is a Peak Trading Interval or an Off-Peak Trading Interval)

6.17.7. For the purpose of clause 6.17.6:

- (a) if the Dispatch Schedule for a Registered Facility for Trading Interval t is greater than the sum of the Resource Plan schedule for the Registered Facility for Trading Interval t and the Balancing Support Contract energy dispatched from the Facility in Trading Interval t as specified by System Management in accordance with clause 7.13(dA), then the applicable price is the Balancing Data price or the price defined in Appendix 1(e)(v) (depending on the context) that was current at the time of Trading Interval t for the Registered Facility, based on Fuel Declarations as modified by data provided by System Management in accordance with clause 7.13.1(eA), for an increase in generation or decrease in consumption, accounting for:
 - i. whether Trading Interval t is a Peak Trading Interval or an Off-Peak Trading Interval; and
 - ii. whether the Registered Facility was running on Liquid Fuel at any time during Trading Interval t.
- (b) if paragraph (a) does not apply, then the applicable price is the Balancing Data price that was current at the time of Trading Interval t for the Registered Facility, based on Fuel Declarations as modified by data provided by System Management in accordance with clause 7.13.1(eA), for a decrease in generation or increase in consumption, accounting for:
 - i. whether Trading Interval t is a Peak Trading Interval or an Off-Peak Trading Interval; and
 - ii. whether the Registered Facility was running on Liquid Fuel at any time during Trading Interval t.

6.17.8. For the purpose of clause 6.17.6:

- (a) if the applicable Balancing Data or Standing Data price for a Registered Facility for Trading Interval t is greater than or equal to MCAP, then the qualifying quantity is the lesser of:
 - i. the Metered Schedule quantity for the Registered Facility for Trading Interval t; and
 - ii. the Dispatch Schedule quantity for the Registered Facility for Trading Interval t; and
- (b) if paragraph (a) does not apply, then the qualifying quantity is the greater of:
 - i. the Metered Schedule quantity for the Registered Facility for Trading Interval t; and

Chapter 6

- ii. the Dispatch Schedule quantity for the Registered Facility for Trading Interval t.

6.17.9. The IMO must determine a Facility Dispatch Tolerance for each Scheduled Generator and Dispatchable Load, where this Facility Dispatch Tolerance is equal to the lesser of:

- (a) 3 MWh; and
 - (b) the greater of:
 - i. 0.5 MWh; and
 - ii. 3% of the Facility's:
 - 1. sent out capacity in the case of a Scheduled Generator; or
 - 2. nominated maximum consumption quantity in the case of a Dispatchable Load,
- as set out in Standing Data.

6.18. Commitment Compensation

6.18.1. Subject to clause 6.18.3, Commitment Compensation will be payable by the IMO to a Market Participant (other than **the Electricity Generation Corporation**) in the event that:

- (a) the Market Participant is instructed by System Management to start up a Scheduled Generator registered by the Market Participant more times than indicated in the applicable Resource Plan for that Scheduled Generator; or
- (b) the Market Participant is instructed by System Management to shutdown a Scheduled Generator registered by the Market Participant more times than indicated in the applicable Resource Plan for that Scheduled Generator.

6.18.2. Subject to clause 6.18.3, the Commitment Compensation equals the sum of:

The options in this rule have been simplified as there is only one commitment and decommitment cost specified in Appendix 1 and there is no obvious reason why different values should apply at peak and off-peak times, especially since the cap on how large the shut down cost can be is the same at all times of the day.

- (a) for each additional start up required of a Scheduled Generator during a Peak Trading Interval or Off-Peak Trading Interval the dollar amount for a commitment of the Facility specified in Standing Data, as defined in Appendix 1(c)(i); and
- (b) [Blank]
- (c) for each additional shut down required of a Scheduled Generator during a Peak Trading Interval or Off-Peak Trading Interval the dollar amount for a de-

commitment of the Facility specified in Standing Data as defined in Appendix 1(c)(i).

(d) [Blank]

6.18.3. No Commitment Compensation will be payable:

- (a) to the Electricity Generation Corporation;
- (b) for the first start in the Trading Day of a Scheduled Generator if the relevant Market Participant has Reserve Capacity Obligations in respect of that Facility; or
- (c) for any start-up or shut-down instructed by System Management in connection with any Ancillary Services Contract, Balancing Support Contract or Network Control Service Contract.

In the latter cases payments are made under the contract, so no additional payments are necessary.

Market Advisories and Energy Price Limits

6.19. Market Advisories

6.19.1. A Market Advisory is a notification by the IMO to Market Participants, Network Operators and System Management of an event that will, or is likely to, significantly impact on market operations.

6.19.2. The IMO must issue a Market Advisory for future potential events described in clause 6.19.1 if the IMO considers there to be a high probability that the event will occur within 48 hours of the time of issue.

6.19.3. Market Advisories must be released as soon as practical after the IMO becomes aware of a situation requiring the release of a Market Advisory.

6.19.4. The IMO must inform Market Participants, Network Operators and System Management of the withdrawal of a Market Advisory as soon as practical once the situation that the Market Advisory relates to has finished.

6.19.5. The types of Market Advisories are:

- (a) Market systems outages – for situations where the scheduling or communication systems required for the normal conduct of the scheduling processes under these Market Rules are, or are expected to be, unavailable; and
- (b) Market suspension – for situations where any component of the Market Rules, or the entire Market Rules, have been, or are about to be, suspended for any reason.

Chapter 6

6.19.6. A Market Advisory must contain the following information:

- (a) the type of Market Advisory;
- (b) the date and time that the Market Advisory is released;
- (c) the time period for which the Market Advisory is expected to apply;
- (d) details of the situation that the Market Advisory relates to, including the extent and seriousness of the situation;
- (e) any actions the IMO plans to take in response to the situation;
- (f) any actions Market Participants or Network Operators are required to take in response to the situation; and
- (g) any actions Market Participants or Network Operators may voluntarily take in response to the situation.

6.19.7. Subject to clause 6.19.8 Market Participants and Network Operators must comply with directions that the IMO issues in any Market Advisory under clause 6.19.6(f).

6.19.8. A Market Participant or Network Operator is not required to comply with clause 6.19.7 if such compliance would endanger the safety of any person, damage equipment, or breach any applicable law.

6.19.9. Market participants, Network Operators and System Management must inform the IMO as soon as practical if they become aware of any circumstances that might reasonably be expected to result in the IMO issuing a Market Advisory.

6.20. Energy Price Limits

6.20.1. The Energy Price Limits are:

- (a) the Maximum STEM Price;
- (b) the Alternative Maximum STEM Price;
- (c) the Minimum STEM Price; and
- (d) Maximum Shutdown Price.

6.20.2. Subject to clause 6.20.11, the Maximum STEM Price to apply for:

- (a) the Relevant Year commencing on 1 October 2004 is equal to \$150/MWh; and
- (b) for subsequent Relevant Years is the Maximum STEM Price for the preceding Relevant Year multiplied by $\text{CPI}[x]$ divided by $\text{CPI}[x-1]$, where $\text{CPI}[x]$ represents the weighted average of the Consumer Price Index All Groups values for the eight Australian State and Territory capital cities as determined by the Australian Bureau of Statistics for the quarter ending June 30 immediately preceding the start of the Relevant Year and $\text{CPI}[x-1]$ represents the corresponding value for the quarter ending the preceding June 30;

Chapter 6

with the exception that from the date and time that a revised Maximum STEM Price takes effect in accordance with clause 6.20.11, that revised value supersedes the current value and is to be the value used as the Maximum STEM Price for the remainder of the Relevant Year in which it takes effect and will be deemed to have applied for the whole of the preceding calendar year when applying paragraph (b) in respect of the following Relevant Year.

6.20.3. The Alternative Maximum STEM Price is to equal:

- (a) from 8 AM on June 1, 2004, \$385/MWh; and
- (b) from 8 AM on the first day of each subsequent month the Alternative Maximum STEM Price for the preceding month multiplied by the amount determined as follows:
 - i. the average of the daily Singapore Crude Oil price, expressed in Australian dollars, for the 90 days ending on the 15th day of the preceding month as published by the International Energy Agency in its monthly Oil Market Report or as otherwise determined by the IMO; divided by;
 - ii. the average of the daily Singapore Crude Oil price, expressed in Australian dollars for the 90 days ending on the 15th day of the month prior to the preceding month as published by the International Energy Agency in its monthly Oil Market Report or as otherwise determined by the IMO,

rounded to the nearest whole dollar, where a half dollar is rounded up;

with the exception that from the date and time that a revised Alternative Maximum STEM Price takes effect in accordance with clause 6.20.11, that revised value supersedes the current value and is to be the value used as the Alternative Maximum STEM Price for the remainder of the month in which it takes effect and will be deemed to have applied for the whole of that month when applying paragraph (b) in respect of the following month.

Thus if the price starts at \$385 at June 1, 2004, and the 90 day average Singapore Crude Oil price for period ending 15th of May was \$30, and the corresponding average as at 15th June was \$33 then the price cap from July 1 will be $\$385 \times 1.1 = \423.5 . But if as at 15th July the average had dropped back to \$30 then the price cap from 1 August would be $\$423.5 \times 0.91 = \385 .

6.20.4. The Minimum STEM Price to apply at any time is to be the Maximum STEM Price multiplied by negative one.

6.20.5. Subject to clause 6.20.11, the Maximum Shutdown Price to apply for:

- (a) the Relevant Year commencing on 1 October 2004 is equal to \$55/MW; and

Chapter 6

- (b) for subsequent Relevant Year is the Maximum Shutdown Price for the preceding Relevant Year multiplied by the $CPI[x]$ divided by $CPI[x-1]$, where $CPI[x]$ represents the weighted average of the Consumer Price Index All Groups values for the eight Australian State and Territory capital cities as determined by the Australian Bureau of Statistics for the quarter ending June 30 immediately preceding the start of the Relevant Year and the $CPI[x-1]$ represents the corresponding value for the quarter ending the preceding June 30.

This price cap should be regarded as provisional and may be subject to review.

The Maximum Shutdown Price limits the standing data shutdown price submitted by the participant, based on the minimum dispatchable loading MW. Note that if the facility is actually shut down MCAP will also apply over the minimum dispatchable loading capacity, and as MCAP will probably be negative, this would be an additional payment to the generator.

6.20.6. The IMO must annually review the appropriateness of the value of the Energy Price Limits.

6.20.7. In conducting the review required by clause 6.20.6 the IMO:

- (a) may propose revised values for the following:
- i. the Maximum STEM Price, where this is to be based on the IMO's estimate of the short run marginal cost of the highest cost generating works in the SWIS fuelled by natural gas and is to be calculated using the methodology described in paragraph (b); and
 - ii. the Alternative Maximum STEM, where this is to be based on the IMO's estimate of the short run marginal cost of the highest cost generating works in the SWIS fuelled by distillate and is to be calculated using the methodology described in paragraph (b);
- (b) must calculate the Maximum STEM Price or Alternative Maximum STEM Price using the following methodology:

$$(1 + \text{Profit Margin}) \times (\text{Variable O\&M} + (\text{Heat Rate} \times \text{Fuel Cost})) / \text{Loss Factor}$$

Where

- i. Profit Margin is the allowable profit margin expressed as a fraction;
- ii. Variable O&M is the variable operating and maintenance costs for a 40 MW open cycle gas turbine generating station expressed in \$/MWh;
- iii. Heat Rate is the average of a 40 MW open cycle gas turbine generating station's heat rate at minimum and maximum capacities, expressed in GJ/MWh;

- iv. Fuel Cost is the unit fixed and variable fuel cost for a 40 MW open cycle gas turbine generating station expressed in \$/GJ; and
- v. Loss Factor is the marginal loss factor for the generator relative to the Reference Node.

Where the IMO must determine appropriate values for the factors described in paragraphs (i) to (v) as applicable to the Maximum STEM Price and Alternative Maximum STEM Price:

6.20.8.

- (a) In conducting the review required by clause 6.20.6 the IMO may re-assess the appropriateness of the value of the Maximum Shutdown Price.
- (b) The value of the Maximum Shutdown Price is to be based on the IMO's estimate of the opportunity cost of lost revenue based on the likely values for MCAP.
- (c) The factors considered in setting the Maximum Shutdown Price must be limited to:
 - i. average MCAP in Off-Peak Trading Intervals;
 - ii. the expected duration of shut downs;
 - iii. minimum generation capacity of the unit most likely to be required to be shutdown;
 - iv. average of that unit's heat rate at minimum and maximum capacities, expressed in GJ/MWh;
 - v. variable fuel costs of that unit expressed in \$/GJ; and
 - vi. variable operating and maintenance costs of that unit, expressed in \$/MWh.

6.20.9. The IMO must prepare a draft report describing how it has arrived at a proposed revised value of an Energy Price Limit. The IMO must publish the report on the Market Web-Site and advertise the report in newspapers widely published in Western Australia and request submissions from all sectors of the Western Australia energy industry, including end-users, within six weeks of the date of publication.

6.20.10. After considering the submissions on the draft report described in clause 6.20.9, the IMO must propose a final revised value for any proposed change to an Energy Price Limit and submit those values and its final report, including submissions received on the draft report, to the Economic Regulation Authority for approval.

6.20.11. A proposed revised value for any Energy Price Limit replaces the previous value after:

Chapter 6

- (a) the Economic Regulation Authority has approved that value in accordance with clause 2.26; and
 - (b) the IMO has posted a notice on the Market Web Site of the new value of the applicable Energy Price Limit,
- with effect from the time specified in the IMO's notice.

In addition to the review set out here, under clause 2.26 the ERA will perform a more comprehensive review after 5 years.

Settlement Data

6.21. Settlement Data

6.21.1. The IMO must provide the following information to the settlement system for each STEM auction:

- (a) a flag for each Trading Interval indicating if the STEM auction was suspended for that Trading Interval;
- (b) the STEM Clearing Price in each Trading Interval in units of dollars per megawatt hours; and
- (c) for each Market Participant participating in the STEM auction, the STEM quantity scheduled in each Trading Interval, in units of megawatt hours, where this amount must be positive for a sale of energy to the IMO and negative for a purchase of energy from the IMO.

Note that in the STEM sales and purchases are relative to the bilateral contract position, so a sale of energy to the IMO may correspond to a reduction in consumption rather than physical supply, and a purchase from the IMO may correspond to a reduction in supply rather than physical consumption.

6.21.2. The IMO must provide the following information to the Settlement System for each Trading Interval in a Trading Day:

- (a) MCAP, UDAP and DDAP; and
- (b) for each Market Participant:
 - i. the Authorised Deviation Quantity;
 - ii. the Upward Unauthorised Deviation Quantity;
 - iii. the Downward Unauthorised Deviation Quantity;
 - iv. the Resource Plan Deviation Quantity;
 - v. the Dispatch Instruction Payment; and
 - vi. any Commitment Compensation due to the Market Participant.

7 Dispatch

A summary of the dispatch obligations:

Market Participants other than **the Electricity Generation Corporation** must follow their accepted Resource Plans unless they are superseded by Dispatch Instructions issued by System Management. If Dispatch Instructions are issued, these Market Participants must follow the Dispatch Instructions.

System Management must schedule the Registered Facilities of **the Electricity Generation Corporation** to accommodate the accepted Resource Plans of the other Market Participants, subject to the Reliability and Security criteria set out in clause 7.7.1.

Where System Management cannot schedule the Registered Facilities of **the Electricity Generation Corporation** to accommodate the accepted Resource Plans of the other Market Participants it must issue Dispatch Instructions to those Market Participants, using the Dispatch Merit Orders provided by the IMO and relevant information on response times of generators etc.

Note that System Management and the Electricity Generation Corporation are each allowed to enter into Balancing Support Contracts with non-**Electricity Generation Corporation** generators to assist **the Electricity Generation Corporation**'s plant to provide the balancing service, and System Management can call on these facilities as if they were part of **the Electricity Generation Corporation**'s portfolio of plant. Also **System Management** can call on other Market Participant's generation facilities if it would otherwise have to use **Liquid Fuelled** plant.

Data used in the Dispatch Process

7.1. Data Used in the Dispatch Process

7.1.1. System Management must maintain the following data set, and must use this data set when determining which Dispatch Instructions it will give:

- (a) Standing Data on Registered Facilities determined in accordance with clause 2.34;
- (b) Loss Factors determined in accordance with clause 2.27;
- (c) expected Scheduled Generator and Non-Scheduled Generator capacities by Trading Interval determined in accordance with clauses 3.17.5, 3.17.6 and 3.17.8;
- (d) transmission Network configuration and capacity by Trading Interval determined in accordance with clauses 3.17.5, 3.17.6 and 3.17.8;

Chapter 7

- (e) forecasts of load and Non-Scheduled Generation by Trading Interval determined in accordance with clause 7.2;
- (f) Ancillary Service Requirements for each Trading Interval determined in accordance with clause 7.2.4;
- (g) schedules of approved Planned Outages for generating works and transmission equipment by Trading Interval determined in accordance with clause 3.19;

Although most outages must be planned in advance of the Trading Day, System Management may still under clause 3.19.2 allow opportunistic maintenance where this does not affect power system security or reliability

- (h) transmission Forced Outages and Consequential Outages by Trading Interval received from Network Operators in accordance with clause 3.21;
- (i) Generator, Dispatchable Load, Curtailable Load and Interruptible Load Forced Outages and Consequential Outages by Trading Interval received from Market Participants in accordance with clause 3.21;
- (j) Resource Plans by Trading Interval received from the IMO in accordance with clause 7.4;
- (jA) the Fuel Declarations received from the IMO in accordance with clause 7.5;
- (k) the Dispatch Merit Order received from the IMO in accordance with clause 7.5;
- (l) Supplementary Capacity Contract data, if any, received from the IMO in accordance with clause 4.24; and
- (m) Network Control Service Contract data, if any, received from the IMO in accordance with clause 5.7.1.

7.1.2. System Management must continually modify its records of the data described in clause 7.1.1 as System Management becomes aware of changes in that data.

7.2. Load Forecasts and Ancillary Service Requirements

7.2.1. System Management must prepare:

- (a) a Load Forecast for a Trading Day by 7:30 AM on the Scheduling Day for the Trading Day, where this Load Forecast is for information purposes; and
- (b) a Load Forecast for a Trading Day by 1:30 PM on the Scheduling Day for the Trading Day, where this Load Forecast is to be used in the dispatch process.

7.2.2. The Load Forecasts for a Trading Day described in clause 7.2.1 must:

- (a) represent Non-Dispatchable Load, Curtailable Load and Interruptible Load net of forecast Non-Scheduled Generation;

Chapter 7

- (b) predict values for both MWh and MW total demand for each Trading Interval in the Trading Day; and
- (c) be Loss Factor adjusted to the Reference Node.

7.2.3. System Management must update the Load Forecast for a Trading Day described in clause 7.2.1(b), as required, to reflect:

- (a) revised weather forecasts;
- (b) higher or lower actual demand than predicted; and
- (c) higher or lower Non-Scheduled Generation than predicted.

System Management will provide the Load Forecasts it uses in the dispatch process for each Trading Interval to the IMO with settlement data.

7.2.3A. By 8:30 AM on the Scheduling Day, System Management must determine for each Market Participant that is a provider of Ancillary Services:

- (a) an estimate of the Loss Factor adjusted MWh of energy that could potentially be called upon by System Management after 1:00 PM on the Scheduling Day to meet Ancillary Service requirements for each Trading Interval of the Trading Day where these estimates must reflect the Ancillary Service standards described in clause 3.10; and
- (b) a list of Facilities that it might reasonably expect to call upon to provide the energy described in (a).

7.2.3B. System Management must provide:

- (a) the information determined in clauses 7.2.1(a) to the IMO by 7:30 AM on the Scheduling Day; and
- (b) the information determined in clauses 7.2.3A to the IMO by 8:30 AM on the Scheduling Day.

7.2.3C. If the IMO does not receive information described in clause 7.2.3B by the required time, it must arrange for System Management to provide the information by alternative means prior to 7:50 AM in the case of the information described in clause 7.2.3B(a) and 8:50 AM in the case of the information described in clause 7.2.3B(b).

7.2.3D. The IMO must confirm receipt of the submissions described in clauses 7.2.3B and 7.2.3C to System Management within five minutes of receiving the submission.

7.2.4. System Management must determine the actual quantity of Ancillary Services required by location for each Trading Interval of the Trading Day in accordance with the Ancillary Service standards described in clause 3.10.

7.2.5. Each Market Generator must by 10 AM each day provide to System Management for each of its Intermittent Generators with capacity exceeding 10 MW its most current

Chapter 7

forecast of the MWh energy output of the Intermittent Generator for each Trading Interval between noon of the current Scheduling Day and the end of the corresponding Trading Day in a format and by a method specified in the Power System Operation Procedure.

7.2.6. System Management may only use forecasts provided to it in accordance with clause 7.2.5 for the purpose of setting and revising requirements for Ancillary Service and to update its dispatch plans during the Trading Day.

7.3. Outages

Outage planning and scheduling appears in clauses 3.18 - 3.21

7.3.1. System Management must take account of Planned Outages in determining Dispatch Instructions.

7.3.2. System Management must, from the time it is notified of a Forced Outage or Consequential Outage in accordance with clause 3.21.4, take account of the Forced Outage or Consequential Outage in determining Dispatch Instructions.

7.3.3. [Blank]

7.3.4. System Management must provide to the IMO the following information:

(a) a schedule of Planned Outages, Forced Outages and Consequential Outages for each Registered Facility of which System Management is aware at that time;

(b) [Blank]

for each Trading Interval of a Trading Day, between 8:00 AM and 8:30 AM on the Scheduling Day prior to the Trading Day.

7.3.5. [Blank]

7.3.6. If the IMO does not receive the information described in clause 7.3.4 by the required time, it must arrange for System Management to provide the information by alternative means prior to 9:00 AM.

7.3.7. The IMO must confirm receipt of the submissions described in clauses 7.3.4 and 7.3.6 to System Management within five minutes of receiving the submission.

7.4. Resource Plans

7.4.1. The IMO must provide System Management with the Resource Plans for a Trading Day it has accepted from Market Participants by 1.30 PM of the Scheduling Day.

Chapter 7

- 7.4.2. Upon receipt of the Resource Plans for a Trading Day, System Management must within 5 minutes confirm to the IMO that it has received the Resource Plans.
- 7.4.3. In the event that the IMO does not receive confirmation of receipt of the Resource Plans for a Trading Day from System Management within five minutes of providing them under clause 7.4.1, the IMO must contact System Management by telephone. If System Management has not received the Resource Plans, then the IMO must make alternative arrangements to communicate the information.
- 7.4.4. At any time between the time that it receives the Resource Plans for a Trading Day from the IMO and the end of the Trading Intervals covered by the Resource Plans, System Management may request that a Market Participant confirm that it can conform to its Resource Plan for the relevant Trading Intervals and, if not, to indicate what lesser level of compliance the Market Participant is capable of achieving.

7.5. Dispatch Merit Orders and Fuel Declarations

- 7.5.1. The IMO must provide System Management with the Dispatch Merit Orders and Fuel Declarations for a Trading Day by 1:30 PM on the Scheduling Day.
- 7.5.2. Upon receipt of the Dispatch Merit Orders and Fuel Declarations for a Trading Day, System Management must within 5 minutes confirm to the IMO that it has received the Dispatch Merit Orders and Fuel Declarations.
- 7.5.3. In the event that the IMO does not receive confirmation of receipt of the Dispatch Merit Orders and Fuel Declarations for a Trading Day from System Management within 5 minutes of submission, then the IMO must contact System Management. If System Management has not received the Dispatch Merit Orders and Fuel Declarations, then the IMO must make alternative arrangements to communicate the information.
- 7.5.4. Subject to clause 7.5.5, a Market Participant other than the Electricity Generation Corporation may at any time between 1:30 PM on the Scheduling Day and 30 minutes prior to the commencement of the Trading Interval described in (b) notify System Management that the Market Participant will change the fuel upon which a Scheduled Generator registered to it will operate on from a Liquid Fuel to a Non-Liquid Fuel, or vice versa, where the notification must include:
- (a) the identity of the Scheduled Generator;
 - (b) the first Trading Interval in the Trading Day from which the fuel change will take effect;
 - (c) the last Trading Interval in the Trading Day for which the fuel change will apply; and
 - (d) the fuel (Liquid Fuel or Non-Liquid Fuel) to be used;

Chapter 7

7.5.5. A Market Participant may only issue a notification in accordance with clause 7.5.4 for a Scheduled Generator if:

- (a) the Scheduled Generator is switching from Non-Liquid Fuel to Liquid Fuel because it has lost its supply of Non-Liquid Fuel; or
- (b) the Scheduled Generator is switching from Liquid Fuel to Non-Liquid Fuel because it has obtained a new supply of Non-Liquid Fuel.

A notification that breaches clause 7.5.5. would effectively be fraud and should be subject to a significant Civil Penalty.

7.5.6. System Management must retain a record of all notifications provided to it in accordance with clause 7.5.4.

7.5.7. In employing the Dispatch Merit Orders, System Management must assume that a Facility is operating on the fuel indicated for that Facility in the applicable Fuel Declaration except for Trading Intervals where the most recent notification received in accordance with clause 7.5.4 implies an alternative fuel is being used.

Dispatch Process

7.6. The Dispatch Criteria

7.6.1. When scheduling and dispatching the Registered Facilities of the Electricity Generation Corporation and issuing Dispatch Instructions to other Market Participants, System Management must seek to meet the following criteria, in descending order of priority:

- (a) to enable operation of the SWIS within the Technical Envelope parameters appropriate for the applicable Operating State;
- (b) to minimise involuntary load shedding on the SWIS; and
- (c) to maintain Ancillary Services to meet the Ancillary Service standards appropriate for the applicable Operating State.

7.6.2. Subject to clauses 7.6.1, 7.6.2A, 7.6.3, 7.6.4, 7.6.6, System Management must schedule and dispatch the Registered Facilities of the Electricity Generation Corporation and Registered Facilities covered by any Balancing Support Contract or Ancillary Service Contract in such a way as to allow the implementation of the Resource Plans that it has received from the IMO for Market Participants other than the Electricity Generation Corporation.

Hence System Management must dispatch the Electricity Generation Corporation facilities around the IPPs' schedules, meeting any residual load.

Chapter 7

Under clause 7.10.1, Market Participants other than the Electricity Generation Corporation must operate their Registered Facilities in accordance with their Resource Plans unless and until these are superseded by Dispatch Instructions issued by System Management.

7.6.2A. Where the Dispatch Criteria requires System Management to alter the Dispatch Plan of the Electricity Generation Corporation, subject to the limitations imposed by this clause 7.6, System Management must employ reasonable endeavours to minimise the change in the Dispatch Plan and to have regard for the merit order of Electricity Generation Corporation Facilities.

7.6.3. Where meeting the criteria in clause 7.6.1 would otherwise require the use of Liquid Fuelled Registered Facilities of the Electricity Generation Corporation or Liquid Fuelled Registered Facilities covered by any Balancing Support Contract, or Ancillary Service Contract, then System Management may issue Dispatch Instructions to Market Participants other than the Electricity Generation Corporation that, if followed, will allow it to meet the criteria in clause 7.6.1, provided that in issuing such Dispatch Instructions System Management does not issue Dispatch Instructions with respect to a Facility that would result in that Facility using Liquid Fuel.

So the order is Electricity Generation Corporation non-liquid, then IPP non-liquid, then Electricity Generation Corporation liquid...

7.6.4. Where System Management cannot meet the criteria in clause 7.6.1 by scheduling and dispatching the Registered Facilities of the Electricity Generation Corporation and Registered Facilities covered by any Balancing Support Contract, or Ancillary Service Contract in such a way as to allow the implementation of the Resource Plans that it has received from the IMO for Market Participants other than the Electricity Generation Corporation, System Management must issue Dispatch Instructions to Market Participants other than the Electricity Generation Corporation that will allow it to meet the criteria in clause 7.6.1.

...then any other IPP facility (i.e. IPP liquid)

7.6.5. Where System Management has issued a Dispatch Instruction in accordance with clause 7.6.3 or clause 7.6.4, but subject to clause 7.6.5A circumstances have changed, and it would not be able to issue the Dispatch Instruction under the relevant clause in the changed circumstances, System Management must cancel the Dispatch Instruction and issue directions to the relevant Market Participant in respect of the relevant Registered Facility to return to its Resource Plan for the relevant Trading Interval.

7.6.5A. System Management must not issue a Dispatch Instruction solely because a Market Participant has notified it of a change in fuel in accordance with clause 7.5.4, with the exception that if a Market Participant notifies System Management of a change in

Chapter 7

fuel after System Management has issued a Dispatch Instruction then System Management may change that Dispatch Instruction accordingly.

Clause 7.6.5A is included to make it clear that if a Facility must change to operating on a high cost fuel then this is no grounds for System Management to dispatch that facility down. However, System Management may dispatch it down if other factors come into play, such as system security, or if the market participant declares it has changed its fuel AFTER a dispatch instruction has been issued (This provides a counter measure to the problem that a declared fuel change could be issued falsely by a market participant so as to ensure a higher pay-as-bid balancing price).

7.6.6. System Management may issue Dispatch Instructions to Market Participants other than **the Electricity Generation Corporation**:

- (a) in accordance with any Ancillary Service Contract;
- (b) in accordance with any Balancing Support Contract;
- (c) in accordance with any Network Control Service Contract;
- (d) in connection with any test of equipment allowed under these Market Rules; or
- (e) under clause 7.6.3 or clause 7.6.4.

Ancillary Services contracts between System Management and an IPP might specify rules by which the contracted IPP schedules their facilities appropriately at the time of submission of **Resource Plans**. Alternatively, System Management can issue a Dispatch Instruction in real-time to achieve the same result. However, the Dispatch Instruction will be settled like any other Dispatch Instruction in the market, so this will need to be recognised in the Ancillary Services contract, which may specify additional payments between the System Management and the IPP, outside of the market

7.6.7. System Management and the Electricity Generation Corporation may each enter into Balancing Support Contracts with Market Participants other than **the Electricity Generation Corporation** to assist them in meeting their obligations under this Chapter 7.

7.6.8. Where it intends to enter into a Balancing Support Contract, System Management must:

- (a) seek to minimise the cost of meeting its obligations under clause 7.6.2; and
- (b) give consideration to using a tender process, unless System Management considers that this would not meet the requirements of paragraph (a).

7.6.9. Where System Management has entered into a Balancing Support Contract, System Management must report the capacity contracted and the terms for calling on the capacity to the IMO.

Chapter 7

7.6.10. Where a Market Participant has Capacity Credits granted in respect of a Curtailable Load:

- (a) the IMO must provide System Management with the details of the Reserve Capacity Obligations to enable System Management to dispatch the Curtailable Load.
- (b) System Management may issue directions to the Curtailable Load in accordance with the Reserve Capacity Obligations

7.6.11. Where the IMO has entered into Supplementary Capacity Contracts:

- (a) the IMO must provide System Management with the details of the Supplementary Capacity Contract to enable System Management to dispatch the services provided under it. Despite this, the IMO must not provide System Management with the payments terms of the contracts, which must be kept confidential.
- (b) System Management may call upon the relevant resource to provide services under any Supplementary Capacity Contract in accordance with the terms of the contract.

7.6.12. System Management may give a direction to a Market Participant (other than the Electricity Generation Corporation) in respect of a Scheduled Generator or Non-Scheduled Generator registered by the Market Participant with regard to the reactive power output of that Facility in accordance with any power factor required under the Technical Rules applying to the relevant Network.

System Management can already issue such instructions to the Electricity Generation Corporation facilities under clause 7.6.2.

7.6.13. System Management must document in the Power System Operation Procedure the procedure to be followed, and must follow that documented Market Procedure, when scheduling and dispatching Registered Facilities covered by any Balancing Support Contract or Ancillary Service Contract in a form sufficient for audits and investigations under these Market Rules.

Note that the ERA will be able to access this information in its monitoring role set out in Chapter 2.

7.6A. Scheduling and Dispatch of the Electricity Generation Corporation

7.6A.1. This clause 7.6A describes the rules governing the relationship between System Management and the Electricity Generation Corporation for the purpose of scheduling and dispatching the Registered Facilities of the Electricity Generation Corporation.

7.6A.2. With respect to the scheduling of the Electricity Generation Corporation Facilities

- (a) At least once every month, the Electricity Generation Corporation must provide to System Management the following information in regard to the subsequent month:
- i. A plant schedule describing the merit order in which the Facilities are to be called upon and any restrictions on the operations of such Facilities;
 - ii. A plan for which fuels will be used in each Facility and guidance as to how that plan might be varied depending on circumstance; and
 - iii. A description as to how Ancillary Services are to be provided; where the format and time resolution of this data is to be described in a procedure.
- (b) System Management must provide to the Electricity Generation Corporation by 8:30 AM on the Scheduling Day associated with a Trading Day a forecast of total system demand for the Trading Day where the format and time resolution of this data is to be described in a procedure.
- (c) System Management must provide to the Electricity Generation Corporation by 12:30 PM on the Scheduling Day associated with a Trading Day:
- i. a forecast of the requirements for the Electricity Generation Corporation energy, being a forecast of the whole of system energy requirement less the aggregate Net Contract Positions of other Market Participants, for the Trading Day;
 - ii. the Dispatch Plan for each Facility for the Trading Day;
 - iii. a forecast of the detailed Ancillary Services required from each Facility;
- where the format and time resolution of this data is to be described in a procedure.
- (d) System Management must consult with the Electricity Generation Corporation in developing the information described in (c) and the Electricity Generation Corporation must provide System Management with any information required by System Management in accordance with a procedure to support the preparation of the information in (c). In the event of any failure by the Electricity Generation Corporation to provide information required by System Management in a timely fashion then System Management may use its reasonable judgement to substitute its own information.
- (e) By 2:30 PM on the Scheduling Day associated with a Trading Day System Management must either confirm the Dispatch Plan specified in (c) with the Electricity Generation Corporation or notify the Electricity Generation Corporation of changes to the Dispatch Plan and forecast fuel requirement to reflect any changes required to accommodate Resource Plans or any changes in conditions.

- (f) If after 2:30 PM on the Scheduling Day but prior to the start of a Trading Interval on the corresponding Trading Day, System Management becomes aware of a change in conditions which will require a significant change in the Dispatch Plan it may make such change but must notify the Electricity Generation Corporation of such change.
- (g) The Electricity Generation Corporation must notify System Management as soon as practicable if it becomes aware that is unable to comply with a Dispatch Plan, providing reasons as to why it cannot comply.

7.6A.3. With respect to the dispatch of Electricity Generation Corporation Facilities during a Trading Day:

- (a) System Management may instruct Facilities to deviate from the Dispatch Plan, or to change their commitment or output, in accordance with the Dispatch Criteria or in response to System Management's powers under a High Risk Operating State or an Emergency Operating State; and
- (b) System Management must provide adequate notice to the Electricity Generation Corporation, based on Standing Data, before a Facility is required to respond to an instruction given under (a).
- (c) The Electricity Generation Corporation must notify System Management as soon as practicable if it becomes aware that is unable to comply with an instruction given under (a).

7.6A.4. With respect to the dispatch compliance of the Electricity Generation Corporation:

- (a) System Management may deem the Electricity Generation Corporation to be in non-compliance for a Trading Interval if the Electricity Generation Corporation fails to comply with the Dispatch Plan, its obligations to provide Ancillary Services, or an instruction given under clause 7.6A.3(a), to an extent that could endanger Power System Security;
- (b) In determining whether or not to deem the Electricity Generation Corporation to be in non-compliance, System Management must give due regard to any reasonable mitigating circumstances of which the Electricity Generation Corporation has notified it in accordance with clause 7.6A.3(c);
- (c) In determining whether or not to deem the Electricity Generation Corporation to be in non-compliance, System Management may only consider a deviation by an individual Electricity Generation Corporation facility from an output level specified in any instruction from System Management to be non-compliance if the deviation at any time exceeds 10 MW; and
- (d) In the event that System Management deems the Electricity Generation Corporation to be in non-compliance for a Trading Interval then System Management must determine a single MWh quantity describing the total non-compliance of the Electricity Generation Corporation for that Trading Interval.

7.6A.5. With respect to administration and reporting:

- (a) Representatives of System Management and the Electricity Generation Corporation must meet at least once per month to review the procedures operating under this clause 7.6A. The minutes of these meetings must be recorded by System Management;
- (b) At the meetings described in (a), System Management and the Electricity Generation Corporation must use best endeavours to address any issues arising from the application of the procedures operating under this clause 7.6A. Where agreement cannot be reached either party may seek arbitration by the IMO.
- (c) System Management must report to the IMO any instance where it believes that the Electricity Generation Corporation has failed to meet its obligations under this clause 7.6A.
- (d) The Electricity Generation Corporation may report to the IMO any instance where it believes that System Management has failed to meet its obligations under this clause 7.6A.
- (e) Upon request by the IMO, the Electricity Generation Corporation and System Management must make available to the IMO records created because of the operation of this clause 7.6A and procedures required by this clause 7.6A.

7.6A.6. The Electricity Generation Corporation and System Management must retain all records, including meeting minutes, created because of the operation of this clause 7.6A and procedures required by this clause 7.6A.

7.6A.7. Subject to clause 7.6A.8, System Management must document the procedures System Management and the Electricity Generation Corporation must follow to comply with this clause 7.6A, including the process to follow in developing the confidential procedure described in clause 7.6A.8, in the Power System Operation Procedure, and System Management and the Electricity Generation Corporation must follow that documented Market Procedure.

7.6A.8. Any procedure created or data exchanged in accordance with this clause 7.6A which is commercially sensitive information of the Electricity Generation Corporation must not be included in the Power System Operation Procedure. Instead, such information must be included in a confidential procedure developed by System Management in consultation with the Electricity Generation Corporation.

7.6A.9. System Management must obtain the approval of the IMO prior to the confidential procedure described in clause 7.6A.8, or any amendments to that private procedure, being enacted.

7.6A.10. The IMO may only decline to approve the confidential procedure, or an amendment to that procedure, if that document is inconsistent with the Market Rules

or the market objectives or if it contains material which, in the reasonable view of the IMO, should be in the Power System Operation Procedure.

Clause 10.8.2 defines almost all Electricity Generation Corporation data in this section to be Rule Participant Dispatch Restricted Information which means it can only be seen by the Electricity Generation Corporation, System Management, the IMO, and regulatory/government agencies. The only exception is declarations by the Electricity Generation Corporation that it cannot comply with schedules/instructions (which cannot be confidential if the market is to have some degree of transparency in understanding events on the power system).

Note that there are no provisions for the Rule Participant Dispatch Restricted Information of this section to ever become public. However, Dispatch Schedules, which are currently Rule Participant Restricted, are eventually made public.

7.7. Dispatch Instructions

7.7.1. A Dispatch Instruction is an instruction issued by System Management to a Market the Electricity Generation Corporation Participant other than directing that the Market Participant vary the output or consumption of one of its Registered Facilities from the level indicated in its Resource Plan, or to vary the output of any Registered Facility holding Capacity Credits but not included in a Resource Plan, for specified Trading Intervals.

7.7.2. Each Dispatch Instruction must:

- (a) be consistent with the latest data described in clause 7.1.1 available to System Management at the time the Dispatch Instruction is determined;
- (b) be applicable to a specific Registered Facility;
- (c) be issued at a time that takes into account the Standing Data minimum response time for the Registered Facility.

Each non-Electricity Generation Corporation facility will have a minimum response time. A dispatch instruction will not be valid if it is issued to the participant without giving sufficient time to for implementation.

7.7.3. Each Dispatch Instruction must contain the following information:

- (a) the Registered Facility to which the Dispatch Instruction relates;
- (b) the time the Dispatch Instruction was issued;
- (c) the time by which response to the Dispatch Instruction is required to commence (which must not be earlier than the time it was issued, except as contemplated by clause 7.7.7(b));
- (d) the required level of sent out generation or consumption which may be either:

Chapter 7

- i. a target MW output; or
- ii. a minimum MW level; and

The last type of dispatch instructions allow for situations where System Management can't be precise about the quantity – for example the automatic activation of reserves under an Ancillary Services contract, or a situation where System Management asks a facility to generate as much as it can for a short time. In such cases System Management must still record the Dispatch instruction for the settlement process, but the exact amount will be deemed to be the metered schedule.

- (e) the ramp-rate to maintain until the required level of sent out generation or consumption is reached.

7.7.4. System Management must determine which Facilities will be the subject of Dispatch Instructions by applying the Dispatch Merit Order relevant to the action required, except where:

- (a) System Management believes it is not feasible to do so having regard to:
 - i. the Standing Data minimum response times; or
 - ii. transmission, ramping or other operational constraints; or
- (b) the Dispatch Instruction is issued in connection with an Ancillary Service Contract, a Network Control Service Contract, a Balancing Support Contract or any test of equipment allowed under these Market Rules; or
- (c) the Dispatch Merit Order would otherwise require that System Management curtail a Curtailable Load when, due to limitations on the availability of the Curtailable Load, such curtailment would prevent that Curtailable Load from being available to System Management at a later time when it would have greater benefit with respect to maintaining Power System Security and Power System Reliability.

7.7.4A. When selecting Curtailable Loads from the Dispatch Merit Order System Management must select them in accordance with the Power System Operations Procedure, where the selection process specified in the Power System Operations Procedure must only discriminate between Curtailable Loads based on size of the capacity, response time, availability and cost of different Curtailable Loads.

7.7.5. A Dispatch Instruction for a Trading Interval must not be issued earlier than 2:00 PM on the Scheduling Day for the Trading Day on which the Trading Interval falls or later than the end of the Trading Interval.

7.7.5A. For the purpose of determining the quantity described in clause 6.17.6(c)(i) for a Non-Scheduled Generator for each Trading Interval the quantity is:

- (a) in the case of a Non-Scheduled Generator included in a Resource Plan, to be the greater of zero and the MWh difference between the Resource Plan MWh

Chapter 7

quantity of the Non-Scheduled Generator less the MWh output of the Non-Scheduled generator over the Trading Interval implied by its Dispatch Instruction; and

- (b) in the case of a Non-Scheduled Generator not included in a Resource Plan, System Management's estimate of the MWh reduction in output, by Trading Interval, of the Non-Scheduled Generator as a result of System Managements Dispatch Instruction.

7.7.5B. A Market Participant may provide System Management with information specified in the Power System Operation Procedure to support the calculation of the quantity described in clause 7.7.5A(b).

7.7.5C. The Power System Operation Procedure must specify that actual wind data for the site of a wind farm and the number of turbines operating, if made available by a Market Participant to System Management, are sufficient to allow System Management to determine what the output of a wind farm would have been had no Dispatch Instruction been issued.

7.7.5D. For the purpose of determining the quantity described in clause 6.17.6(d)(i) for a Curtailable Load for each Trading Interval the quantity is the level of curtailment requested by System Management in its Dispatch Instructions:

7.7.6. Subject to clause 7.7.7:

- a) System Management must issue a Dispatch Instruction by communicating it to the relevant Market Participant by telephone, allowing sufficient time for the Market Participant to confirm and to respond to that Dispatch Instruction; and
- b) when issued a Dispatch Instruction in accordance with (a), a Market Participant must confirm receipt of the Dispatch Instruction and as soon as practicable confirm its ability to comply with the Dispatch Instruction.

7.7.7. Clause 7.7.6 does not apply where:

- (a) System Management has operational control of the relevant Registered Facility in accordance with clause 7.8, in which case System Management may communicate the Dispatch Instruction at a later time and by a method agreed with the Market Participant; or
- (b) the Dispatch Instruction is deemed to have been issued in respect of a Registered Facility in accordance with an Ancillary Service Contract or Network Control Service Contract and relates to the automatic activation of the Ancillary Service or Network Control Service in which case System Management may communicate the Dispatch Instruction to the relevant Market Participant at a later time in accordance with the Ancillary Services contract or Network Control Service Contract .

Chapter 7

- 7.7.8. System Management must record all Dispatch Instructions, including confirmations of receipt received from Market Participants, in a form sufficient for independent audit and for settlement purposes.
- 7.7.9. System Management must document the procedure System Management and Market Participants must follow in forming, issuing, recording, receiving and confirming Dispatch Instructions and in determining the quantities described in clauses 7.7.5A and 7.7.5D in the Power System Operation Procedure, and:
- (a) System Management must follow that documented Market Procedure when issuing, recording, and confirming a Dispatch Instruction and in determining the quantities described in clauses 7.7.5A and 7.7.5D; and
 - (b) Market Participants must follow that documented Market Procedure when receiving and confirming a Dispatch Instruction and in providing information to support the calculation of the quantity described in clause 7.7.5A.

7.8. Dispatch Instructions Implemented by System Management

This clause is required because there may be facilities under the direct control of System Management. This might include Gas Turbine activation and reductions in wind farm output. While both types of facilities could be operated by a Market Participant under instruction from System Management (and this will not be precluded) the costs involved in manning facilities may mean that Market Participants find it attractive to come to an agreement to hand this control to System Management.

- 7.8.1. System Management may, by agreement with a Market Participant, maintain operational control over aspects of a Registered Facility, including, but not limited to:
- (a) the starting, loading and stopping of one or more of that Market Participant's Scheduled Generators;

This relates to gas turbines that are directly controlled by System Management.

- (b) limiting the output of one or more of that Market Participant's Non-Scheduled Generators.

This relates to wind farms that are directly controlled by System Management.

- 7.8.2. The maintenance of operational control of a Registered Facility by System Management does not remove the obligation on System Management to produce Dispatch Instructions for those Registered Facilities.
- 7.8.3. A Market Participant's rights and obligations under these Market Rules in respect of a Facility are not affected or modified where System Management maintains operational control over the Facility in accordance with this clause 7.8. In particular, the compliance obligations described in clause 7.10 remain with the Market Participant responsible for the Registered Facilities to which clause 7.8.1 relates.

Chapter 7

7.9. Commitment

- 7.9.1. Subject to clause 7.9.2, if a Market Participant (other than the Electricity Generation Corporation) intends to synchronise a Scheduled Generator, then it must confirm with System Management the expected time of synchronisation
- (a) at least one hour before the expected time of synchronisation; and
 - (b) must update this advice five minutes before synchronising.
- 7.9.2. Clause 7.9.1(a) does not apply where System Management has issued a Dispatch Instruction to the Facility that requires synchronisation within one hour of the Dispatch Instruction being issued.
- 7.9.3. System Management may request that a Market Participant who has given a confirmation under clause 7.9.1 provide further notification to System Management immediately before synchronisation of the Facility, and the relevant Market Participant must comply with the request.
- 7.9.4. System Management must grant permission to synchronise unless:
- (a) the synchronisation is not in accordance with the relevant Resource Plan or Dispatch Instruction; or
 - (b) System Management considers that it would not be able to meet the criteria set out in clause 7.6.1 were synchronisation to occur.
- 7.9.5. Subject to clauses 7.9.6 and 7.9.6A, if a Market Participant (other than the Electricity Generation Corporation) intends to desynchronise a Scheduled Generator, then it must confirm with System Management the expected time of desynchronisation
- (a) at least one hour before the expected time of desynchronisation; and
 - (b) must update this advice five minutes before desynchronising.
- 7.9.6. Clauses 7.9.5(a) and 7.9.6A do not apply where System Management has issued a Dispatch Instruction to the Facility that requires desynchronisation within one hour of the Dispatch Instruction being issued.
- 7.9.6A. If a Market Participant intends to decommit a Facility to such an extent that it will not be available to be synchronised for four hours or more after the time of desynchronisation then the Market Participant must have been granted permission by System Management to do this in accordance with clause 3.21B.
- 7.9.7. System Management may request that a Market Participant who has given a confirmation under clause 7.9.5 provide further notification to System Management immediately before desynchronisation of the Facility, and the relevant Market Participant must comply with the request.
- 7.9.8. System Management must grant permission to desynchronise unless:

Chapter 7

- (a) the desynchronisation is not in accordance with the relevant Resource Plan or Dispatch Instruction; or
- (b) System Management considers that it would not be able to meet the criteria set out in clause 7.6.1 were desynchronisation to occur.

7.9.9. A Market Participant must comply with a decision of System Management under clause 7.9.4.

7.9.10. Subject to clause 7.9.11, a Market Participant must comply with a decision of System Management under clause 7.9.8.

7.9.11. A Market Participant is not required to comply with clause 7.9.10 if such compliance would endanger the safety of any person, damage equipment, or breach any applicable law.

7.9.12. Where a Market Participant cannot comply with a decision of System Management under clause 7.9.8:

- (a) the Market Participant must inform System Management as soon as practicable; and
- (b) if System Management refused to allow desynchronisation of a Facility but the Market Participant did desynchronise that Facility then System Management must record the desynchronisation as a Forced Outage.

Dispatch Compliance

7.10. Compliance with Resource Plans and Dispatch Instructions

7.10.1. Subject to clause 7.10.2, a Market Participant other than the Electricity Generation Corporation must comply with:

- (a) subject to paragraph (b), its Resource Plan;
- (b) if a Dispatch Instruction has been issued for a Registered Facility for a Trading Interval, the most recently issued Dispatch Instruction applicable to the Registered Facility for the Trading Interval; and
- (c) a direction given to the Market Participant under clauses 7.6 or 7.10.7(a).

7.10.2. A Market Participant is not required to comply with clause 7.10.1 if such compliance would endanger the safety of any person, damage equipment, or breach any applicable law.

7.10.3. Where a Market Participant cannot meet its Resource Plan, Dispatch Instruction, or direction given under clauses 7.6 or 7.10.7(a), as applicable, it must inform System Management as soon as practicable.

Chapter 7

7.10.4. System Management must monitor the behaviour of Market Participants with Registered Facilities to assess whether they are complying with clause 7.10.1 in accordance with its Monitoring and Reporting Protocol.

7.10.5. Where System Management considers that a Market Participant has not complied with clause 7.10.1 in relation to any of its Registered Facilities in a manner that:

- (a) threatens Power System Security or Power System Reliability;
- (b) would require System Management to issue instructions to the Registered Facilities of **the Electricity Generation Corporation** or Registered Facilities covered by any Balancing Support Contract or Ancillary Service Contract; or
- (c) would require System Management to issue Dispatch Instructions to other Registered Facilities in accordance with clauses 7.6.3 or 7.6.4;

System Management must warn the Market Participant about the deviation and request an explanation for the deviation; and cessation of the behaviour within a time that System Management considers reasonable.

7.10.6. A Market Participant must comply with a request under clause 7.10.5.

7.10.6A. A Market Participant that cannot comply with a request under clause 7.10.5 must notify System Management as soon as practicable and must include an explanation in that notification.

7.10.7. Where the Market Participant does not comply with the request referred to in clause 7.10.5, System Management:

- (a) may issue directions to the Market Participant in respect of the output of that Registered Facility, without regard for the Dispatch Merit Order, with the objective of minimising the dispatch deviations of the Facility;

System Management might require the facility to maintain a constant output, or in extreme cases, System Management could order the facility to go to zero output. Note that such directions are not considered to be Dispatch Instructions, and will not form part of the Dispatch Schedule for the facility – so the facility will be exposed to UDAP and DDAP for the deviation.

- (b) must report the failure to comply with request referred to in clause 7.10.5, to the IMO. As part of the report, System Management must include:
 - i. the circumstances of the failure to comply with clause 7.10.1 and the request referred to in clause 7.10.5;
 - ii. any explanation offered by the Market Participant as provided in accordance with clause 7.10.6A;
 - iii. whether System Management issued instructions to the Registered Facilities of **the Electricity Generation Corporation** or Registered Facilities covered by any Balancing Support Contract or Ancillary

Service Contract or issued Dispatch Instructions to other Registered Facilities as a result of the failure; and

- iv. an assessment of whether the failure threatened Power System Security or Power System Reliability.

Note that failures by **the Electricity Generation Corporation's facilities**, where this causes System Management to issue Dispatch Instructions to the facility of another Market Participant, are covered under System Management's reporting requirements for Dispatch Instructions in clause 7.13.1

There is now no concept of Dispatch Scheduling Errors. The IMO will monitor System Management to ensure it is following the appropriate procedures.

Advisories, Balancing Suspension and Reporting

7.11. Dispatch Advisories

7.11.1. A Dispatch Advisory is a communication by System Management to Market Participants, Network Operators and the IMO that there has been, or is likely to be, an event that will require a significant deviation from Resource Plans or will restrict communication between System Management and any of the Market Participants, Network Operators, or the IMO.

7.11.2. System Management must issue a Dispatch Advisory for future potential events if it considers there to be a high probability that the event will occur within 48 hours of the time of issue.

Events beyond this time will be addressed via the short term PASA updates.

7.11.3. Dispatch Advisories must be released as soon as practical after System Management becomes aware of a situation requiring the release of a Dispatch Advisory.

7.11.3A For the avoidance of doubt, where System Management must respond to an unexpected and sudden event, System Management may issue a Dispatch Advisory after the event has occurred.

7.11.4. System Management must inform Market Participants, Network Operators and the IMO of the withdrawal of a Dispatch Advisory as soon as practical once the situation that the Dispatch Advisory relates to has finished.

7.11.5. System Management must release a Dispatch Advisory in the event of, or in anticipation of situations where:

- (a) involuntary load shedding is occurring or expected to occur;

- (b) committed generation at minimum loading is, or is expected to, exceed forecast load;
- (c) Ancillary Service Requirements will not be fully met;
- (d) significant outages of generation transmission or customer equipment are occurring or expected to occur;
- (e) fuel supply on the Trading Day is significantly more restricted than usual, or if fuel supply limitations mean it is not possible for some Market Participants to supply in accordance with their Resource Plans;
- (f) scheduling or communication systems required for the normal conduct of the scheduling and dispatch process are, or are expected to be, unavailable; or
- (g) [Blank]
- (h) [Blank]
- (i) the system is in, or is expected to be in, a High Risk Operating State or an Emergency Operating State.

7.11.6. A Dispatch Advisory must contain the following information:

- (a) [Blank]
- (b) the date and time that the Dispatch Advisory is released;
- (c) the time period for which the Dispatch Advisory is expected to apply;
- (cA) the operating state to be applicable, or expected to be applicable, at different times during the time period to which the Dispatch Advisory relates;
- (d) details of the situation that the Dispatch Advisory relates to, including the location, extent and seriousness of the situation;
- (e) any actions System Management plans to take in response to the situation;
- (f) any actions Market Participants and Network Operators are required to take in response to the situation; and
- (g) any actions Market Participants may voluntarily take in response to the situation.

7.11.6A. If System Management must issue directions to a Market Participant or a Network Operator under a High Risk Operating State or an Emergency Operating State prior to issuing a Dispatch Advisory then System Management may issue such directions as if a Dispatch Advisory had been issued provided that it informs the relevant Market Participant or Network Operator of the applicable operating state as soon as practical.

It would be better if System Management had to inform the Market Participant or Network Operator of the operating state prior to issuing the direction, but this may not be possible because of time constraints or because the action taken is via automated systems.

Chapter 7

7.11.7. Subject to clause 7.11.8, Market Participants and Network Operators must comply with directions that System Management issues in any Dispatch Advisory under clause 7.11.6(f), or directly to the Market Participant or Network Operator under clause 7.11.6A.

This will be a civil penalty provision.

7.11.8. A Market Participant or Network Operator is not required to comply with clause 7.11.7 if such compliance would endanger the safety of any person, damage equipment, or breach any applicable law.

7.11.9. Market Participants, Network Operators and the IMO must inform System Management as soon as practical if they become aware of any circumstances that might reasonably be expected to result in System Management issuing a Dispatch Advisory.

7.12. Status Reports

7.12.1. System Management must provide a report to the IMO once every three months on the performance of the market with respect to the dispatch process. This report must include details of:

- (a) the incidence and extent of issuance of Dispatch Instructions;
- (b) the incidence and extent of non-compliance with Dispatch Instructions;
- (c) the incidence and extent of transmission constraints;
- (d) the incidence and extent of shortfalls in Ancillary Services, involuntary curtailment of load, High Risk Operating States and Emergency Operating States, together with:
 - i. a summary of the circumstances that caused each such incident; and
 - ii. a summary of the actions that System Management took in response to the incident in each case.

7.12.2. The IMO must publish the report described in clause 7.12.1 after removing any information that cannot be made public under these Market Rules or which it considers should not be made public.

If the IMO must publish the raw report, then this may limit the information that System Management can provide the IMO.

Settlement and Monitoring Data

7.13. Settlement and Monitoring Data

7.13.1. System Management must provide the IMO with the following data for a Trading Day by noon on the first Business Day following the day on which the Trading Day ends:

Chapter 7

- (a) the Operational System Load Estimate in each Trading Interval in the Trading Day;

This is defined in the Glossary and would be an estimate of the system load based on SCADA data (or possibly the generator settlement meters if data from these is available in the right timeframe)

- (b) Load Forecasts prepared by System Management in accordance with clause 7.2.1(b);
- (c) a schedule of all of the Dispatch Instructions that System Management issued for each Trading Interval in the Trading Day by Market Participant and Facility, including the information specified in clause 7.7.3;
- (cA) a schedule of the MWh output of each generating system monitored by System Management's SCADA system for each Trading Interval of the Trading Day;
- (cB) the temperature at the site of each generating system monitored by System Management's SCADA system for each Trading Interval of the Trading Day;
- (cC) the MWh quantity of non-compliance by the Electricity Generation Corporation by Trading Interval;
- (d) a description of the reasons for each Dispatch Instruction issued, including a flag indicating where a Dispatch Instruction was issued in connection with:
- i. any Ancillary Service Contract;
 - ii. any Balancing Support Contract;
 - iii. any Network Control Service Contract;
 - iv. any test of equipment allowed under these Market Rules; or
 - v. any failure of an Electricity Generation Corporation Facility to follow the scheduling and dispatch procedures relating to clause 7.6A;
- (dA) The MWh energy dispatched under a Balancing Support Contract for each Trading Interval in the Trading Day by Facility;

This must be an amount of energy dispatched by System Management. It does not include energy that was called under a Balancing Support Contract but which was scheduled via a Resource Plan. The distinction is that the information in (dA) is used in the calculation of balancing payments to ensure that no payment is made for this energy since it is funded under a contract. No such adjustment is required for energy included in a Resource Plan because that is not exposed to balancing payments.

- (e) the schedule of all Planned Outages, Forced Outages and Consequential Outages relating to each Trading Interval in the Trading Day by Market Participant and Facility;

Chapter 7

- (eA) details of notifications received by System Management in accordance with clause 7.5.4;
- (eB) the estimated decrease, in MWh, in the output of each Intermittent Generator, by Trading Interval, as a result of System Management Dispatch Instructions, as determined in accordance with clause 7.7.5A, where this is to be used in settlement as the quantity described in clause 6.17.6(c)(i).
- (eC) the required decrease, in MWh, in the output of each Curtailable Load, by Trading Interval, as a result of System Management Dispatch Instructions, as determined in accordance with clause 7.7.5D, where this is to be used in settlement as the quantity described in clause 6.17.6(d)(i).
- (f) [Blank]
- (g) details of the instructions provided to:
 - i. Curtailable Loads that have Reserve Capacity Obligations; and
 - ii. providers of Supplementary Capacity;on the Trading Day; and
- (h) the identity of the Facilities which were subject to either a Commissioning Test or a test of Reserve Capacity for each Trading Interval of the Trading Day.

7.13.2. System Management must maintain systems capable of providing the data described in clause 10.5.1(y) to the Market Web Site as soon as practicable following the completion of a Trading Interval.

8 Wholesale Market Metering

Metering Data Agents will be the Network Operators under the Market Rules, but a Network Operator other than the Electricity Network Corporation will be able to choose not to fulfil this function, in which case the Electricity Network Corporation will do it.

Note that we say nothing here about cost recovery for meters or meter reading activities – this is expected to be covered elsewhere.

Metering Data Agents

8.1. Metering Data Agents

- 8.1.1. There must be a Metering Data Agent for each Network.
- 8.1.2. Subject to clause 8.1.4, the Network Operator is also the Metering Data Agent for any Network registered by that Network Operator.
- 8.1.3. A Metering Data Agent must operate to the relevant Metering Protocol.
- 8.1.4. If the Network Operator in respect of a Network notifies the IMO and the Network business unit of the Electricity Network Corporation that it does not wish to be the Metering Data Agent for a Network registered by that Network Operator, the Network business unit of the Electricity Network Corporation will be the Metering Data Agent for that relevant Network.

Note that the possibility exists for there to be a single Metering Code applicable to all Market Participants. At such time as the Metering Code is created, the Metering Protocol may be replaced with the Metering Code.

8.2. Duties of a Metering Data Agent

- 8.2.1. A Metering Data Agent must:
 - (a) keep the Meter Registry updated in accordance with clause 8.3; and
 - (b) provide metering data to the IMO in accordance with clause 8.4.

Meter Registry

8.3. Meter Registry

- 8.3.1. Each Metering Data Agent must maintain a separate Meter Registry for each Network it serves. At a minimum, the Meter Registry for a Network must:
 - (a) record each meter connected to the Network;

Chapter 8

- (b) record the Market Participant(s) whose generation or consumption is measured by the meter;
- (c) facilitate changes to the identity of the Market Participant(s) whose generation or consumption is measured by a meter as of a specified time;
- (d) record how metered quantities are to be allocated between Market Participants if more than one Market Participant's generation or consumption is measured by that meter.

A meter registry is likely to also track which retail consumer is associated with a meter. However this is not mentioned as information about retail consumers has no relevance to these Market Rules.

8.3.2. In processing a Facility registration application under clause 2.31, the IMO must notify the applicable Metering Data Agent that it requires confirmation that all Meter Registry information associated with that application is correct.

8.3.3. A Metering Data Agent must within five Business Days from the day of being notified by the IMO in accordance with clause 8.3.2 confirm the Meter Registry information.

8.3.4. If the IMO accepts a Facility registration or Facility deregistration, it must notify the Metering Data Agent for the relevant Network and the Metering Data Agent must, within five Business Days, ensure that the Meter Registry is adjusted accordingly.

Previously two Business Days were used in clauses 8.3.3 and 8.3.4 but five Business Days has now been allowed given the potential quantity of meters affected if there were to be a major shift of meters from one Market Customer to another.

8.3.5. A Metering Data Agent must notify the IMO of any changes to the identities of the Market Participants whose supply or consumption is measured by a meter not less than 10 Business Days prior to the Meter Data Agent making a Meter Data Submission that reflects the changed metering arrangements.

8.3.6. The IMO must provide a Metering Data Agent with confirmation of a notification made in accordance with clause 8.3.5 within one Business Day.

8.3.7. If a Metering Data Agent fails to receive a confirmation of receipt in accordance with clause 8.3.6 it must contact the IMO within one Business Day to appraise the IMO of the failure of the IMO to provide confirmation of receipt and, if necessary, to make alternative arrangements for the submission of the information.

Meter Data Submissions

8.4. Meter Data Submission

- 8.4.1. A Metering Data Agent must provide meter data submissions to the IMO in accordance with the times specified in clauses 9.16.2(a), 9.16.2(g) and 9.16.3.
- 8.4.2. A Meter data submission must be in the format described in clause 8.6.
- 8.4.3. A Meter data submission must be made using the Settlement Submission System.
- 8.4.4. Upon receipt of a meter data submission, the IMO must provide a Metering Data Agent with confirmation of receipt of a meter data submission made in accordance with clause 8.4.1 within one hour.

This confirmation could be automatically generated by the settlement system, or could be a manual confirmation such as a phone call or email.

- 8.4.5. If a Metering Data Agent fails to receive confirmation of receipt of a meter data submission in accordance with clause 8.4.4, it must contact the IMO by telephone within one hour of failing to receive confirmation in accordance with clause 8.4.4 to appraise the IMO of the failure of the IMO to provide confirmation of receipt and, if necessary to make alternative arrangements for the submission of the information.

8.5. Notices of Disagreement and Disputed Meter Data

- 8.5.1. In the event of a Notice of Disagreement or Notice of Dispute that relates to meter data, the IMO must notify the Metering Data Agent responsible for that data of the Notice of Disagreement or Notice of Dispute.
- 8.5.2. A Metering Data Agent must respond to the notification described in clause 8.5.1 in accordance with the Metering Protocol referred to in clause 8.1.3 and must include any revised meter data in the first meter data submission made to the IMO following any correction of the meter data.

8.6. Format of Meter Data Submissions

- 8.6.1. A meter data submission must comprise:
 - (a) the identity of the Metering Data Agent;
 - (b) the Trading Month to which the meter data relates;
 - (c) for each interval meter and each Trading Interval in the Trading Month described in (b):
 - i. the identity of the meter;

The IMO will already know which meter is associated with each Market Participant based on registration data.

- ii. the MWh quantity measured by the meter; and
 - iii. whether the quantity described in (ii) is based on an actual meter reading or an estimate, and if based on an estimate, the applicable code describing the reason for the estimate;
- (d) [Blank]; and
- (e) meter adjustments that stem from actual meter data becoming available or from the resolution of a dispute concerning meter data (“**meter dispute**”) in accordance with the dispute resolution process in the applicable Metering Protocol, including:
- i. for each interval meter and each Trading Interval in the calendar month to which a meter dispute has resulted in changes to meter data:
 - 1. the MWh quantity for that meter;
 - 2. whether the quantity described in paragraph (1) is based on an actual meter reading or an estimate, and if based on an estimate, the applicable code describing the reason for the estimate; and
 - 3. the applicable code describing the reason for the change in the MWh quantity relative to the previously stated value.
 - ii. [Blank]
 - iii. [Blank]

8.6.2. The IMO must document:

- (a) the format of meter data submissions;
- (b) [Blank]

in the Settlement Procedure, and Metering Data Agents must comply with that documented Market Procedure when developing and submitting meter data submissions.

Metering Protocol Requirements

8.7. Metering Protocol Requirements

8.7.1. A Metering Data Agent must operate in accordance with a Metering Protocol. As a minimum a Metering Protocol must prescribe:

- (a) that the Metering Data Agent maintains a Meter Registry tracking a unique identifying number for each meter and the location of that meter, and indicating which Market Participant, if any, is associated with that meter;

Chapter 8

- (b) that interval meter data is recorded for a 30 minute period starting on the hour and on the half-hour;
- (c) a process for replacing missing or inaccurate metering data with estimated data to be included in Meter Data Submissions;
- (d) a process for addressing metering data errors stemming from errors in meter reading, failure to read a meter and falsification;
- (e) a dispute resolution process pertaining to actions taken in accordance with that Metering Protocol; and
- (f) a process exists for modification of the Metering Protocol in the event of changes to the Market Rules.

While a Metering Protocol should also address issues such as check metering, access to information, auditing of information, location of metering; interference with metering etc, these requirements will be imposed by other instruments and commercial agreements between Metering Data Agents and Market Participants. The purpose of the preceding clause is simply to specify the minimum requirements to achieve conformity with the requirements of Wholesale Market operation.

Support of Calculations

8.8. Support of Calculations

- 8.8.1. Each Metering Data Agent must provide to the IMO within five Business Days of being requested, any of the meter information held by the Metering Data Agent that is required by the IMO for the purposes of these Market Rules.

9 Settlement

Introduction

9.1. Conventions

9.1.1. Settlement is to be based on whole Trading Days, though partial Trading Days are to be facilitated on the first and last day of a financial year and at the commencement of the market. For this purpose, the IMO may declare that part of a Trading Day is to be treated as if that part was a full Trading Day by notice published on the Market Web Site.

9.1.2. With respect to the treatment of GST:

- (a) all prices, fees and other charges under these Market Rules (other than under this clause 9.1.2) are exclusive of GST;
- (b) in this clause 9.1.2, “**GST**”, “**GST group**”, “**input tax credit**”, “**member**”, “**recipient created tax invoice**”, “**representative member**”, “**supply**”, “**tax invoice**” and “**taxable supply**” each have the meaning given to the relevant term in the legislation under which GST is imposed;
- (c) where a Rule Participant makes a taxable supply to another Rule Participant or person under these Market Rules, the other Rule Participant or person must also pay the first Rule Participant making the supply an additional amount equal to the GST payable in respect of that supply;
- (d) the IMO must include in Settlement Statements and Invoices issued under these Market Rules the additional amounts contemplated by paragraph (c);
- (e) Rule Participants must, if requested by the IMO, do everything necessary (including the entering into of recipient created tax invoice agreements) to enable the IMO to issue valid tax invoices, recipient created tax invoices and adjustment notes in respect of all taxable supplies made by or to the IMO under these Market Rules;
- (f) however, if the additional amount paid or payable to a Rule Participant or another person under this clause 9.1.2 in respect of a taxable supply differs from the actual amount of GST payable by the Rule Participant under the relevant legislation in respect of the relevant supply, then adjustments must be made under clause 9.21 so as to ensure the additional amount paid under this clause in respect of the supply is equal to the actual amount of GST payable under the relevant legislation in respect of the supply;
- (g) if the IMO determines that:
 - i. a party is entitled to payment of any costs or expenses by way of reimbursement or indemnity; or

- ii. a price, fee or other charge payable under these Market Rules (other than Market Fees, System Operation Fees and Regulator Fees) is calculated with reference to a cost or expense incurred by a party, then the payment or cost or expense (as the case may be) must exclude any part of the cost or expense which is attributable to GST for which the party (or a representative member of any GST group of which the party is a member) is entitled to an input tax credit.

There are a number of GST related issues the resolution of which awaits the establishment of the IMO. The IMO is likely to need to apply for a Private Tax Ruling similar to one obtained by NEMMCO so as to minimise the complexity of applying GST in the context of an electricity market. In addition, it would be desirable for the IMO to enter into arrangements with Market Participants to allow the IMO to prepare tax invoices on behalf of Market Participants for situations where Market Participants are selling to the IMO.

- 9.1.3. Where these Market Rules indicate interest is payable on an amount, interest accrues daily at the Bank Bill Rate from (and including) the date that payment was due up to (but excluding) the date of payment, or in the case of an adjusted Settlement Statement provided under clause 9.19 from (and including) the payment due date for the Invoice issued for the original Settlement Statement up to (but excluding) the actual date of payment for the Invoice issued for the adjusted Settlement Statement.

Note that no compound interest applies and the same interest rate applies under default as under normal processes. At some point it might be desirable to consider introducing a higher default interest rate.

- 9.1.4. Except where otherwise stated, the IMO will perform all calculations described in this chapter.

9.2. Settlement Procedure

- 9.2.1. The IMO must document the settlement process, including the application of taxes and interest, in the Settlement Procedure, and the IMO and Market Participants must follow that documented Market Procedure.

Settlement Data

9.3. Data Collection

- 9.3.1. The following information is to be used by the IMO in performing its settlement obligations:
 - (a) the Ancillary Service, and outage compensation settlement data described in clause 3.22;
 - (b) the Reserve Capacity settlement data described in clause 4.29;

Chapter 9

- (c) the Network Control Service settlement data described in clause 5.9; and
- (d) the Energy Market Settlement data described in clause 6.21.

9.3.2. Metering Data Agents must provide to the Settlement System, settlement ready metering data in accordance with Chapter 8.

9.3.3. The IMO must determine the Metered Schedule for each Facility and Non-Dispatchable Load for each Trading Interval.

9.3.4. Subject to clause 2.30B.10, the Metered Schedule for a Trading Interval for a Facility or Non-Dispatchable Load, excluding those Non-Dispatchable Loads referred to in clause 9.3.4A, is the net quantity of energy generated and sent out into the relevant Network or consumed by the Facility or Non-Dispatchable Load (as applicable) during that Trading Interval, Loss Factor adjusted to the Reference Node, and determined from meter data submissions received by the IMO in accordance with clause 8.4 or SCADA data received from System Management in accordance with clause 7.13.1(cA) where interval meter data is not available.

9.3.4A. The IMO must determine a single Metered Schedule for a Trading Interval for those Non-Dispatchable Loads without interval meters or with meters not read as interval meters that are served by the Electricity Retail Corporation where:

- (a) the Metered Schedule equals the Notional Wholesale Meter value for that Trading Interval;
- (b) the Notional Wholesale Meter value for a Trading Interval equals negative one multiplied by:
 - i. the sum of the Metered Schedules with positive quantities for that Trading Interval; plus
 - ii. the sum of the Metered Schedules with negative quantities for that Trading Interval;

where the Metered Schedules referred to in (i) and (ii) exclude the Metered Schedule for the Notional Wholesale Meter.

Clause 2.27.2A states that, for the purpose of these Market Rules, where a Loss Factor must be applied to a Notional Wholesale Meter value, e.g. to convert it back to consumption at the connection point, then the system average loss factor applicable to small loads and as described in clause 2.27.2(f) is to apply.

9.3.5 For the purpose of clauses 9.3.4 and 9.3.4A, a quantity of energy generated and sent out into the relevant Network has a positive value and a quantity of energy consumed has a negative value.

9.3.6. Market Participants may provide the Capacity Credit Allocation Submissions described in clause 9.4. to the IMO.

Chapter 9

9.3.7. The IMO must determine the Consumption_Share(p,m) for Market Participant p in each Trading Month m, which equals

- (a) the Market Participant's contributing quantity; divided by
- (b) the total contributing quantity of all Market Participants,

where the contributing quantity for a Market Participant for Trading Month m is the sum of the Metered Schedules for the Non-Dispatchable Loads, Interruptible Loads, Curtailable Loads, and Dispatchable Loads registered to the Market Participant for all Trading Intervals during Trading Month m.

Consumption share is used in allocation of costs relating to some ancillary services, commitment compensation and balancing surpluses and shortfalls.

9.4. Capacity Credit Allocation Process

9.4.1. A Market Participant holding Capacity Credits may make a single Capacity Credit Allocation Submission applicable for a full Trading Month to the IMO between the dates and times specified in clauses 9.16.2(b)(i) and 9.16.2(b)(ii).

Submissions can be made between ten and five Business Days prior to the Non-STEM Settlement Statement being produced.

9.4.2. The IMO must prescribe a Capacity Credit Allocation Submission form and publish it on the Market Web Site.

9.4.3. A Market Participant making a Capacity Credit Allocation Submission must provide to the IMO the information specified in clause 9.5.1 using the form prescribed by the IMO and the method prescribed in the Settlement Procedure.

9.4.4. By making a Capacity Credit Allocation Submission, a Market Participant acknowledges that:

- (a) it is acting with the permission of all affected Market Participants; and
- (b) the IMO has the right to reverse any Capacity Credit Allocations if any affected Market Participant, other than the submitting Market Participant, objects to the allocation prior to the deadline for disputes in relation to Non-STEM Settlement Statements.

If the transfer was not authorised by a Market Participant then it can object at the time Non-STEM Settlement Statements are issued, or can seek redress via its contract subsequent to the deadline for lodging disagreements to Non-STEM Settlement Statements.

Except with respect to clause 9.4.10, the IMO is not required to investigate Capacity Credit Allocations to ensure that the appropriate permissions have been given.

Chapter 9

9.4.5. As soon as practical, and not later than noon on the Business Day following receipt of a Capacity Credit Allocation Submission, the IMO must notify the submitting Market Participant by facsimile or e-mail:

- (a) that the Capacity Credit Allocation Submission has been received;
- (b) whether the Capacity Credit Allocation Submission has been accepted or rejected, including reasons for rejecting the submission (if appropriate); and
- (c) that all individual allocations of Capacity Credits in the submission are provisional until confirmation is provided in accordance with clause 9.4.13.

9.4.6. If a submitting Market Participant does not receive a notice in accordance with clause 9.4.5, or is notified that the submission is rejected, then the submitting Market Participant must arrange with the IMO to provide a valid Capacity Credit Allocation Submission, by mutually agreed means, not later than the date and time specified in clause 9.16.2(b)(ii).

If confirmation has not been received by the deadline then it is too late. Hence the practical deadline is slightly earlier.

9.4.7. The IMO must confirm receipt, by telephone, of a Capacity Credit Allocation Submission from a Market Participant made in accordance with clause 9.4.6 within 30 minutes of receiving the submission, indicating the matters referred to in paragraphs 9.4.5(a), (b) and (c).

9.4.8. The IMO must accept a Capacity Credit Allocation Submission unless the submission is not consistent with the requirements of clause 9.5.

9.4.9. Once all Capacity Credit Allocation Submissions have been received by the IMO it must identify each Market Participant which has had more Capacity Credits allocated to it than are required to cover its Individual Reserve Capacity Requirements.

9.4.10. The IMO must, by the time and date specified in clause 9.16.2(b)(iii) contact any Market Participant referred to in clause 9.4.9 and request the Market Participant to nominate modifications to the total number of Capacity Credits allocated to it under each individual Capacity Credit Allocation Submission to ensure that the total Capacity Credits allocated do not exceed the Market Participant's Individual Reserve Capacity Requirement.

The intention of clause 9.4.10 is to prevent the hoarding of Capacity Credits. If a Market Customer holds more Capacity Credits than is required to cover its Individual Reserve Capacity Requirement then this may prevent other Market Customers covering their own Individual Reserve Capacity Requirement. To stop this, the IMO will not accept the allocation of Capacity Credits to a Market Customer in excess of the requirements of that Market Customer, forcing the Market Customer to trade its excess bilaterally if it wishes them to maintain any value.

Chapter 9

Clause 9.4.11 below means that if more Capacity Credits are assigned to a Market Customer than it requires, and if that Market Customer does not rectify the situation, then the allocation of Capacity Credits to it will be revoked. This may seem extreme, but it should be noted that (a) this action is only taken if the Market Customer does not resolve the situation when asked, and (b) the Market Customer can still settle bilateral trades of Capacity Credits outside of the IMO's settlement systems (albeit with some impact on prudential obligations). If the IMO were only to reject the surplus Capacity Credits then this would not create a disincentive to the hoarding of Capacity Credits (other than the cost of procuring those Capacity Credits in the first instance).

9.4.11. A Market Participant requested to nominate modifications in accordance with clause 9.4.10 must respond by e-mail or facsimile by the time and date specified in clause 9.16.2(b)(iv).

9.4.12. If a Market Participant requested to nominate modifications in accordance with clause 9.4.10 does not comply with clause 9.4.11, all Capacity Credit Allocation Submissions, insofar as they allocate Capacity Credits to that Market Participant, will be revoked and will be disregarded by the IMO.

9.4.13. By the time and date specified in clause 9.16.2(b)(v), the IMO must give each Market Participant from which the IMO has received a Capacity Credit Allocation Submission which has been accepted the following information (for each Market Participant allocated Capacity Credits in the submission):

- (a) the Capacity Credits allocations accepted as submitted; and
- (b) if the IMO has contacted the Market Participant under clause 9.4.10:
 - i. the Capacity Credit allocations that have been reduced in accordance with responses made by that Market Participant under clause 9.4.11, where the IMO must allocate reductions between the sets of Capacity Credits specified in clause 9.5.1(c) so as to maximise the settlement payments to be made by the IMO for the unallocated Capacity Credits held by the submitting Market Participant.

Thus if the transaction is for 10 Capacity Credits covered by a Special Reserve Capacity Price of \$10 and 10 Capacity Credits covered by a Special Reserve Capacity Price of \$5, and we have to remove 10 Capacity Credits, then we will remove the 10 \$5 Capacity Credits.

- ii. the Capacity Credit allocations that have been revoked in accordance with clause 9.4.12 due to the IMO not receiving a response from a Market Participant.

The IMO must give the information required under this clause by e-mail or by facsimile.

If an Individual Capacity Credit Allocation is modified or revoked, the parties in question can still settle their bilateral trade of Capacity Credits outside the market. This approach has been taken because we do not want Market Consumers to hold Capacity Credits in excess of their Individual Reserve Capacity Requirements, and arbitrarily adjusting submissions will tend to result in funds that should only have been exchanged between the allocating Market Participant and the Market Participant to which they have been allocated being transferred to other parties, limiting the ability of the parties to the arrangement to “square up” their settlement positions outside the market.

9.5. Format of Capacity Credit Allocation Submissions

9.5.1. A Capacity Credit Allocation Submission must set out:

- (a) the identity of the submitting Market Participant, which must be the holder of Capacity Credits;
- (b) the identity of each Market Participant to which the Capacity Credits are to be allocated for settlement purposes, which may include the submitting Market Participant;

Market Participants with generation and load are free to allocate Capacity Credits to themselves, subject to the other standard limits on allocations. While it may seem intuitive to make this allocation automatically, this will not always be the best outcome for a Market Participant. For example, a Market Participant holding a Special Price Arrangement that returns more than the prevailing Monthly Reserve Capacity Price would prefer not to allocate the Capacity Credit to its own load as it would earn less overall and would effectively lose its Special Price Arrangement.

- (c) the number of Capacity Credits to be allocated for settlement purposes to each other Market Participant from each of the following sets:
 - i. the set consisting of Capacity Credits held by the submitting Market Participant that are covered by Special Price Arrangements but which are allowed to be traded bilaterally under clause 4.14.9, where the total number of Capacity Credits in this set is the number of Capacity Credits specified under clause 4.29.3(d)(iii), less the number of Capacity Credits specified under clause 4.29.3(d)(ii), for the Market Participant for the Trading Month; and
 - ii. the set consisting of Capacity Credits held by the submitting Market Participant which are allowed to be traded bilaterally under clause 4.14.9 that are not covered by Special Price Arrangements, as specified under clause 4.29.3(d)(iv) for the Market Participant for the Trading Month.

9.5.2. A Capacity Credit Allocation Submission may allocate part of a Capacity Credit provided that the number of Capacity Credits allocated is specified to a precision of 0.005 MW.

We cannot simply have the submitting Market Participant indicating the total number of Capacity Credits to be allocated to another Market Participant. This is because some Capacity Credits are covered by Special Price Arrangements and are settled at different prices than other Capacity Credits if not allocated. Hence we need to know what number of each type of Capacity Credit is being allocated. Further, for a Short Term Special Price Arrangement and the first year of a Long Term Special Price Arrangement, the Capacity Credits must have been procured by the IMO through the Reserve Capacity Auction, and consequently are not allowed to be traded bilaterally, and hence cannot be included in a Capacity Credit Allocation Submission.

9.5.3. A Capacity Credit Allocation Submission will only be accepted by the IMO if:

- (a) the total number of Capacity Credits allocated in accordance with clause 9.5.1(c)(i) for a Trading Month does not exceed the number of Capacity Credits specified under clause 4.29.3(d)(iii), less the number of Capacity Credits specified under clause 4.29.3(d)(ii), for the Market Participant for the Trading Month; and

The difference in the values in clauses 4.29.3(d)(iii) and 4.29.3(d)(ii) is the total number of Capacity Credits that are covered by Special Price Arrangements resulting from auctions in previous Reserve Capacity Cycles. These are the only Capacity Credits covered by Special Price Arrangements that may be traded bilaterally.

- (b) the total number of Capacity Credits allocated in accordance with clause 9.5.1(c)(ii) for a Trading Month does not exceed the number of Capacity Credits specified under clause 4.29.3(d)(iv) for the Market Participant for the Trading Month.

The value in clause 4.29.3(d)(iv) is the amount of Capacity Credits that are not covered by Special Price Arrangements.

Settlement Calculations

9.6. STEM Settlement Calculations for a Trading Week

The STEM will be settled on a weekly basis, while other processes will be settled monthly.

9.6.1. The STEM settlement amount for the IMO to Market Participant p for Trading Week w is:

$$\text{STEMSA}(p,w) = \text{Sum}(d \in D, t \in T, \text{STEM Price}(d,t) \times \text{STEM Quantity}(p,d,t) \times \text{SSF}(d,t));$$

Where:

STEM Price(d,t) is the STEM Clearing Price for Trading Interval t of Trading Day d within Trading Week w ;

STEM Quantity(p,d,t) is the quantity of electricity purchased from, or sold to, the IMO through the STEM by Market Participant p for Trading Interval t of

Trading Day d where a quantity sold through the STEM has a positive value, and a quantity purchased through the STEM has a negative value;

$SSF(d,t)$ is the STEM suspension flag where this has a value of zero if the STEM was suspended for Trading Interval t of Trading Day D and a value of one otherwise;

D is the set of all Trading Days in Trading Week w where “ d ” is used to refer to a member of that set; and

T is the set of all Trading Intervals in Trading Day d , where “ t ” is used to refer to a member of that set.

9.7. The Reserve Capacity Settlement Calculations for a Trading Month

9.7.1. The Reserve Capacity settlement amount for Market Participant p for Trading Month m is:

$$\begin{aligned}
 \text{RCSA}(p,m) = & \text{Monthly Reserve Capacity Price}(m) \times (\text{CC_NSPA}(p,m) \\
 & \quad - \text{Sum}(q \in P, \text{CC_ANSPA}(p,q,m))) \\
 + & \text{Sum}(a \in A, \text{Monthly Special Price}(p,m,a) \times (\text{CC_SPA}(p,m,a) \\
 & \quad - \text{Sum}(q \in P, \text{CC_ASPA}(p,q,m,a)))) \\
 - & \text{Capacity Cost Refund}(p,m) \\
 - & \text{Intermittent Load Refund}(p,m) \\
 + & \text{Supplementary Capacity Payment}(p,m) \\
 - & \text{Targeted Reserve Capacity Cost}(m) \times \text{Shortfall Share}(p,m) \\
 - & \text{Shared Reserve Capacity Cost}(m) \times \text{Capacity Share}(p,m) \\
 + & \text{Capacity_LF}(m) \times \text{Capacity Share}(p,m)
 \end{aligned}$$

Note that the load following costs that generators pay for Ancillary Services are based on the total cost of that capacity, but Market Customers have already contributed to those costs via the Reserve Capacity Market. Consequently, it is necessary to rebate some of the payments for Ancillary Services by generators back to Market Customers. The Capacity_LF term represents the share of the Load Following capacity cost component payment by generators. This cost is rebated to Market Customers in proportion to the Individual Reserve Capacity Requirements to counter-act this effect.

Where

Shortfall Share is a consuming Market Participant's share of the cost of funding Supplementary Capacity Contracts, and is simply the ratio of the amount of its Individual Reserve Capacity Requirement not covered by Capacity Credits and the total over all participants of that same amount. This equals zero if all consumers hold adequate Capacity Credits, and in this case there should be no Supplementary Auction Costs to recover.

Capacity Share is just a consuming Market Participant's share of the total Reserve Target.

Chapter 9

Two ways of setting Shortfall Share are defined below. The second equation is the standard approach, and simply reflects a particular Market Participant's share of the total capacity requirements across all Market Participants that have not been bilaterally covered by Capacity Credits. However, if all Market Participants hold sufficient Capacity Credits then the second equation will involve dividing the a number by zero, which is not defined. This equation will also be undefined for Market Participants who hold no Individual Reserve Capacity Requirement as all terms will be zero. Hence we set Shortfall Share to equal zero in this case.

$$\begin{aligned} \text{Shortfall Share}(p,m) = & \\ & 0, \text{ if } \text{Sum}(n \in P, (\text{IRCR}(n,m) - \text{Sum}(q \in P, \text{CC_ANSPA}(q,n,m) \\ & \quad + \text{Sum}(a \in A, \text{CC_ASPA}(q,n,m,a)))))) = 0 \\ & \text{otherwise,} \\ & (\text{IRCR}(p,m) - \text{Sum}(q \in P, \text{CC_ANSPA}(q,p,m) \\ & \quad + \text{Sum}(a \in A, \text{CC_ASPA}(q,p,m,a)))) / \\ & \text{Sum}(n \in P, (\text{IRCR}(n,m) - \text{Sum}(q, \text{CC_ANSPA}(q,n,m) \\ & \quad + \text{Sum}(a \in A, \text{CC_ASPA}(q,n,m,a)))))) \end{aligned}$$

Capacity Share is just the proportion of the required capacity for the SWIS that is assigned to Market Participant p.

$$\text{Capacity Share}(p,m) = \text{IRCR}(p,m) / \text{Sum}(n \in P, \text{IRCR}(n,m))$$

Monthly Reserve Capacity Price(m) is the Monthly Reserve Capacity Price which applies for Trading Day d defined in accordance with clause 4.29.1;

CC_NSPA(p,m) is the number of Capacity Credits held by Market Participant p in Trading Month m that are not covered by Special Price Arrangements;

CC_ANSPA(p,q,m) is the number of Capacity Credits held by Market Participant p in Trading Month m that are not covered by Special Price Arrangements and which are allocated to another Market Participant q for Trading Month m under clauses 9.4 and 9.5;

A is the set of all Special Price Arrangements associated with a Facility where "a" is used to refer to a member of that set;

P is the set of all Market Participants, where "p", "n", and "q" are all used to refer to a member of that set;

Monthly Special Price(p,m,a) is the Monthly Special Reserve Capacity Price for Special Price Arrangement for Market Participant p defined in accordance with clause 4.29.2 which applies for Trading Day d;

CC_SPA(p,m,a) is the number of Capacity Credits held by Market Participant p in Trading Month m that are covered by Special Price Arrangement a;

CC_ASPA(p,q,m,a) is the number of Capacity Credits held by Market Participant p in Trading Month m that are covered by Special Price

Arrangement a and which are allocated to Market Participant q for Trading Month m under clauses 9.4 and 9.5;

IRCR(p,m) is the Individual Reserve Capacity Requirement for Market Participant p and Trading Month m expressed in units of MW;

Capacity Cost Refund(p,m) is the Capacity Cost Refund payable to the IMO by Market Participant p in respect of that Market Participant's Capacity Credits for Trading Month m, as specified in clause 4.29.3(d)(vi);

Intermittent Load Refund(p,m) is the sum over all of Market Participant p's Intermittent Loads of the Intermittent Load Refund payable to the IMO by Market Participant p in respect of each of its Intermittent Loads for Trading Month m, as specified in clause 4.28A.1;

Supplementary Capacity Payment(p,m) is the net payment to be made by IMO under a Supplementary Capacity Contract to Market Participant p for Trading Month m, as specified by the IMO in accordance with clause 4.29.3(e)(i);

Targeted Reserve Capacity Cost(m) is the cost of Reserve Capacity to be shared amongst those Market Customers who have not had sufficient Capacity Credits allocated to them for Trading Month m where this cost is specified for Trading Month m under clause 4.29.3(b);

Shared Reserve Capacity Cost(m) is the cost of Reserve Capacity to be shared amongst all Market Customers for Trading Month m where this cost is specified for Trading Month m under clause 4.29.3(c);

Capacity_LF(m) is the total Load Following service capacity payment cost for Trading Month m as specified by IMO under clause 3.22.1(a).

- 9.7.2. The net payment to be made by IMO under a Supplementary Capacity Contract to a person who is not a Market Participant will be settled by the IMO in accordance with contract conditions which are not required to be consistent with other settlement processes or prudential processes under these Market Rules.

Since we are making payments only, there is no need for prudential obligations.

9.8. The Balancing Settlement Calculations for a Trading Day

- 9.8.1. The balancing settlement amount for Market Participant p for Trading Interval t of Trading Day d is:

$$\text{BSA}(p,d,t) = \text{MCAP}(d,t) \times \text{ADQ}(p,d,t) + \text{UDAP}(d,t) \times \text{UUDQ}(p,d,t) \\ + \text{DDAP}(d,t) \times (\text{DUDQ}(p,d,t) + \text{RPDQ}(p,d,t)) + \text{DIP}(p,d,t)$$

Where

ADQ(p,d,t), is the Authorised Deviation Quantity for Market Participant p for Trading Interval t of Trading Day d calculated in accordance with clause 6.17.2;

UUDQ(p,d,t) is the Upward Unauthorised Deviation Quantity for Market Participant p for Trading Interval t of Trading Day d calculated in accordance with clause 6.17.3;

DUDQ(p,d,t) is the Downward Unauthorised Deviation Quantity, for Market Participant p for Trading Interval t of Trading Day d calculated in accordance with clause 6.17.4;

As defined in Chapter 6, DUDQ and RPDQ are strictly negative or zero.

RPDQ(p,d,t) is the Resource Plan Deviation Quantity for Market Participant p for Trading Interval t of Trading Day d calculated in accordance with clause 6.17.5;

MCAP(d,t) is the Marginal Cost Administered Price for Trading Interval t of Trading Day d calculated in accordance with clause 6.14.2;

UDAP(d,t) is the Upward Deviation Administered Price for Trading Interval t of Trading Day d calculated in accordance with clause 6.14.5;

DDAP(d,t) is the Downward Deviation Administered Price for Trading Interval t of Trading Day d calculated in accordance with clause 6.14.6;

DIP(d,t) is the Dispatch Instruction Payment for Market Participant p for Trading Interval t of Trading Day d calculated in accordance with clause 6.17.6.

9.9. The Ancillary Service Settlement Calculations for a Trading Month

9.9.1. The Ancillary Service settlement amount for Market Participant p for Trading Month m is:

$$\begin{aligned}
 \text{ASSA}(p,m) = & \text{Electricity Generation Corporation AS Provider Payment}(p,m) \\
 & + d(p,i) \times \text{ASP_Payment}(i,m) \\
 & - \text{Load_Following_Share}(p,m) \\
 & \quad \times (\text{Capacity_LF}(m) + \text{Availability_Cost_LF}(m)) \\
 & - \text{Reserve_Cost_Share}(p,m) \\
 & - \text{Consumption_Share}(p,m) \times \text{Cost_LRD}(m)
 \end{aligned}$$

Where

the Electricity Generation Corporation AS Provider Payment(p,m) =
 0 if Market Participant p is not the Electricity Generation Corporation and
 (Availability_Cost_R(m) + Availability_Cost_LF(m) + Cost_LRD(m))
 - Sum(i ∈ I, ASP_Payment(i,m)) otherwise.

The payment for Ancillary Services to the Electricity Generation Corporation does not include the capacity components of the Ancillary Service costs, since the Reserve Capacity payment has already covered these costs. Note that users of the Load Following service pay the full cost, including capacity costs. Market Customers paying for Reserve Capacity receive a rebate on their Reserve Capacity payments equal to the amount paid by the users of the Load Following service. This means that the IMO does not collect the money twice. Users of Spinning Reserve only pay the Availability Cost for these services, with Market Customers fully funding the capacity costs of these services.

The total payment to the Electricity Generation Corporation for the provision of Ancillary Services is just the total costs of the relevant services, less the payments made by System Management under Ancillary Service Contracts.

$d(p,i)$ is 1 if ASP i corresponds to Market Participant p and zero otherwise;

$ASP_Payment(i,m)$ is determined in accordance with clause 9.9.3;

$Load_Following_Share(p,m)$ is the share of the $Cost_LF(m)$ allocated to Market Participant p in Trading Month m , where this is to be determined by the IMO using the methodology described in clause 3.14.1;

$Reserve_Cost_Share(p,m)$ is defined in clause 9.9.2(b);

$Consumption_Share(p,m)$ is the proportion of consumption associated with Market Participant p for Trading Month m determined by the IMO in accordance with clause 9.3.7;

$Capacity_LF(m)$ is the total Load Following service payment cost for Trading Month m as specified by the IMO under clause 3.22.1(a);

$Availability_Cost_R(m)$ is the total Spinning Reserve availability payment costs, excluding Load Following costs, for Trading Month m , as calculated under clause 9.9.2(c);

$Availability_Cost_LF(m)$ is the Load Following availability payment costs for Trading Month m , as calculated under clause 9.9.2(d); and

$Cost_LRD(m)$ is the total Load Rejection Reserve, System Restart, and Dispatch Support services payment costs for Trading Month m as specified by the IMO under clause 3.22.1(g).

9.9.1A. The Ancillary Service settlement amount for Trading Month m for Rule Participant k where Rule Participant k is not a Market Participant is $d(k,i) \times ASP_Payment(i,m)$ where $d(k,i) = 1$ if ASP i corresponds to Rule Participant k and zero otherwise and $ASP_Payment(i,m)$ is determined in accordance with clause 9.9.3.

9.9.2. The following terms related to Ancillary Service availability costs:

(a) the total availability cost for Trading Month m :

$$Availability_Cost(m) = 0.5 \times (Margin_Peak(m) \times \text{Sum}(d \in D, t \in Peak, MCAP(d,t)))$$

$$\begin{aligned}
 & \times (\text{Capacity_R_Peak}(m) - \text{Sum}(i \in I, \text{ASP_SRQ}(i, t))) \\
 & + 0.5 \times (\text{Margin_Off-Peak}(m) \times \text{Sum}(d \in D, t \in \text{Off-Peak}, \text{MCAP}(d, t)) \\
 & \quad \times (\text{Capacity_R_Off-Peak}(m) - \text{Sum}(i \in I, \text{ASP_SRQ}(i, t)))) \\
 & + \text{Sum}(i \in I, \text{ASP_SRPayment}(i, m)) \\
 & + \text{Sum}(i \in I, \text{ASP_LFPayment}(i, m))
 \end{aligned}$$

- (b) the Spinning Reserve Cost Share for Market Participant p , which is a Market Generator, for Trading Month m :

$$\begin{aligned}
 \text{Reserve_Cost_Share}(p, m) = & \\
 & 0.5 \times (\text{Margin_Peak}(m) \times \text{Sum}(d \in D, t \in \text{Peak}, \text{MCAP}(d, t)) \\
 & \quad \times \text{Reserve_Share}(p, t) \\
 & \quad \times (\text{Capacity_R_Peak}(m) - \text{Sum}(i \in I, \text{ASP_SRQ}(i, t) - 0.5 \text{LFR}(m)))) \\
 & + 0.5 \times (\text{Margin_Off-Peak}(m) \times \text{Sum}(d \in D, t \in \text{Off-Peak}, \text{MCAP}(d, t)) \\
 & \quad \times \text{Reserve_Share}(p, t) \\
 & \quad \times (\text{Capacity_R_Off-Peak}(m) - \text{Sum}(i \in I, \text{ASP_SRQ}(i, t) \\
 & \quad \quad \quad - 0.5 \times \text{LFR}(m)))) \\
 & + \text{Sum}(t \in \text{Peak and Off_Peak}, \text{Reserve_Share}(p, t) \\
 & \quad \times \text{Sum}(i \in I, \text{ASP_SRPayment}(i, m) / \text{TITM}))
 \end{aligned}$$

The Availability Cost is an estimate of the opportunity cost of holding capacity out of the schedule to supply Spinning Reserve and Load Following capability. It is based on the capacity required to be procured from the **Electricity Generation Corporation**. For a peak Trading Interval this is the system requirement, Capacity_R_Peak less the Trading Interval quantity of capacity provided under Ancillary Service Contracts. Similar terms apply for off-peak Trading Intervals. The Margin_Peak and Margin_Off-Peak terms are applied to give a return on the capacity provided by **the Electricity Generation Corporation**. The factor of 0.5 is required to convert MW quantities to equivalent Trading Interval MWh quantities.

The Reserve Cost Share reflects the share of the cost of reserve borne by each Market Participant. It is calculated in a similar manner to the Availability Cost with two exceptions. First, the capacity required is further reduced by half of the required load following capacity. The factor of a half appears because the same unit of capacity is getting half its payment as Load Following and half as Spinning Reserve. Second, the term Reserve Share is introduced to account for each facilities share of the cost of reserve by Trading Interval.

The cost of Ancillary Service Contracts for Spinning Reserve over a Trading Month is divided by the number of Trading Intervals in a Trading Month to produce a per Trading Interval amount before being allocated to Market Participants based on their Reserve Share in each Trading Interval.

Note that there is no apparent distinction between peak and off-peak load following requirements in clause 3.13.1(aA)(i)(2), so no distinction has been made between these in (b).

Chapter 9

The terms in (b) are summed to give a total Spinning Reserve availability payment in (c), and this total is subtracted from the total Availability Cost determined in (c) to determine the total Load Following Availability Cost in (d).

(c) the total Spinning Reserve Availability Cost for Trading Month m :

$$\text{Availability_Cost_R}(m) = \text{Sum}(p \in P, \text{Reserve_Cost_Share}(p,m))$$

(d) the total Load Following Availability Cost for Trading Month m :

$$\text{Availability_Cost_LF}(m) = \text{Availability_Cost}(m) - \text{Availability_Cost_R}(m)$$

Where

$\text{ASP_SRQ}(i,t)$ is the quantity of Spinning Reserve provided by Ancillary Service Provider i in Trading Interval t (this being one of the quantities referred to in clause 9.9.3);

$\text{ASP_SRPayment}(i,m)$ is defined in clause 9.9.3;

$\text{ASP_LFPayment}(i,m)$ is defined in clause 9.9.3;

TITM is the number of Trading Intervals in the Trading Month;

$\text{Reserve_Share}(p,m)$ is the share of the $\text{Cost_R}(m)$ allocated to Market Participant p in Trading Month m , where this is to be determined by the IMO using the methodology described in clause 3.14.2;

$\text{Margin_Peak}(m)$ is the reserve availability payment margin applying for Peak Trading Intervals for Trading Month m as specified by the IMO under clause 3.22.1(c);

$\text{Margin_Off-Peak}(m)$ is the reserve availability payment margin applying for Off-Peak Trading Intervals for Trading Month m as specified by the IMO under clause 3.22.1(d);

$\text{Capacity_R_Peak}(m)$ is the capacity necessary to cover the Ancillary Services Requirement for Spinning Reserve for Peak Trading Intervals for Trading Month m as specified by the IMO under clause 3.22.1(e);

$\text{Capacity_R_Off-Peak}(m)$ is the capacity necessary to cover the Ancillary Services Requirement for Spinning Reserve for Off-Peak Trading Intervals for Trading Month m as specified by the IMO under clause 3.22.1(f);

$\text{LFR}(m)$ is the capacity necessary to cover the Ancillary Services Requirement for Load Following for Trading Month m as specified by the IMO under clause 3.22.1(fA);

$\text{MCAP}(d,t)$ has the meaning given in clause 9.8.1;

Peak denotes the set of Trading Intervals occurring during Peak Trading Intervals, where "t" refers to a Trading Interval during a Trading Day;

Off-Peak denotes the set of Trading Intervals occurring during Off-Peak Trading Intervals, where “t” refers to a Trading Interval during a Trading Day; and

D denotes the set of Trading Days within Trading Month m, where “d” is used to refer to a member of that set.

9.9.3. The value of $ASP_Payment(i,m)$ for Ancillary Service Provider i in Trading Month m is the sum of:

- (a) the sum over all Ancillary Service Contracts for Spinning Reserve of $ASP_SRPayment(i,m)$, the payment under that contract;
- (b) the sum over all Ancillary Service Contracts for Load Following of $ASP_LFPayment(i,m)$, the payment under that contract;
- (c) the sum over all Ancillary Service Contracts for Load Rejection Reserve of $ASP_LRPayment(i,m)$, the payment under that contract;
- (d) the sum over all Ancillary Service Contracts for System Restart of $ASP_BSPayment(i,m)$, the payment under that contract; and
- (e) the sum over all Ancillary Service Contracts for Dispatch Support of $ASP_DSPayment(i,m)$, the payment under that contract

where each of the terms $ASP_SRPayment(i,m)$, $ASP_LFPayment(i,m)$, $ASP_LRPayment(i,m)$, $ASP_BSPayment(i,m)$ and $ASP_DSPayment(i,m)$ is determined in accordance with clause 9.9.4.

9.9.4. For each Ancillary Service Provider i and each Ancillary Service Contract, the payments $ASP_SRPayment(i,m)$, $ASP_LFPayment(i,m)$, $ASP_LRPayment(i,m)$, $ASP_BSPayment(i,m)$ and $ASP_DSPayment(i,m)$, as applicable, are

- (a) the applicable monthly dollar value specified by System Management for that Trading Month in accordance with clause 3.22.3(b)(iii)(1); or, if no such value is specified,
- (b) the product of the applicable price specified in clause 3.22.3(b)(iii)(2) for that Trading Month and the sum over Trading Intervals in that Trading Month of the applicable quantities specified in clause 3.22.3(b)(ii).

9.10. The Commitment and Outage Compensation Settlement Calculations for a Trading Month

9.10.1. The Commitment and Outage Compensation settlement amount for Market Participant p for Trading Month m is:

$$\begin{aligned} COCSA(p,m) = & (\text{Com_Compensation}(p,m) + \text{Out_Compensation}(p,m)) \\ & - (\text{Consumption_Share}(p,m) \times \text{Sum}(q, \text{Com_Compensation}(q,m) \\ & + \text{Out_Compensation}(q,m))) \end{aligned}$$

Where

$Com_Compensation(x,m)$ is the sum over all Trading Days in the Trading Month of the Commitment Compensation calculated for Market Participant x (denoted by either p or q) under clause 6.18.1 of the Trading Month;

$Out_Compensation(x,m)$ is the Outage Compensation specified for Market Participant x (denoted by either p or q) for the Trading Month under clause 3.22.1(h); and

$Consumption_Share(p,m)$ is the proportion of consumption associated with Market Participant p for Trading Month m determined by the IMO in accordance with clause 9.3.7.

9.10A. Non-Compliance Charge

9.10A.1. The Non-Compliance Charge settlement amount for Market Participant p for Trading Interval t of Trading Day d is:

If Market Participant p is the Electricity Generation Corporation

$$NCC(p,m) = - \text{Sum}(d \in D, t \in T, CP(d,t) \times \text{ABS}[NCQ(p,d,t)])$$

Otherwise

$$NCC(p,m) = 0$$

Where

$CP(d,t)$, is the non-compliance cost applicable in Trading Interval t of Trading Day d as specified in clause 9.10A.2;

$NCQ(p,d,t)$ is the MWh quantity of non-compliance for Market Participant p for Trading Interval t of Trading Day d as specified by System Management in accordance with clause 7.13.1(cC);

$\text{ABS}[NCQ(p,d,t)]$ means the mathematical absolute value of $NCQ(p,d,t)$;

D denotes the set of Trading Days within Trading Month m , where “ d ” is used to refer to a member of that set.

T denotes the set of all Trading Intervals in Trading Day d , where “ t ” is used to refer to a member of that set.

9.10A.2. The value of the non-compliance cost is to equal the Alternative Maximum STEM Price.

9.11. The Reconciliation of Settlement Calculations for a Trading Month

Reconciliation covers any differences between the money the IMO receives and pays out. It falls upon market consumers in proportion to MWh load in the month. The only possible causes of this difference comes from the Balancing Settlement Amounts, because

- Loss factors used in the market differ from actual loss factors which could create a surplus or shortfall, though will typically create a surplus.

Chapter 9

- The application of deviation prices and pay-as-bid payments that differ from MCAP will tend to create a surplus.

It is likely that the Reconciliation will be a rebate more often than it is a charge.

The (-1) is added because $BSA(q,d,t)$ and $RSA(p,m)$ are settlement amounts for which positive values are credits, and if we pay a positive amount via $BSA(q,d,t)$ then $RSA(p,m)$ is a corresponding charge, and hence has the opposite sign.

9.11.1. The Reconciliation Settlement amount for Market Participant p for Trading Month m is:

$$RSA(p,m) = (-1) \times \text{Consumption_Share}(p,m) \times \text{Sum}(q \in P, d \in D, t \in T, BSA(q,d,t) + NCC(q,d,t))$$

Where

$\text{Consumption_Share}(p,m)$ is the proportion of consumption associated with Market Participant p for Trading Month m determined by the IMO in accordance with clause 9.3.7;

$BSA(q,d,t)$ is the Balancing Settlement Amount for Market Participant q for Trading Day d and Trading Interval t ;

$NCC(q,d,t)$ is the Non-Compliance Charge settlement amount for Market Participant q for Trading Day d and Trading Interval t ;

P is the set of all Market Participants, where “ p ” and “ q ” are both used to refer to a member of that set;

D is the set of all Trading Days in Trading Month m , where “ d ” is used to refer to a member of that set; and

T is the set of all Trading Intervals in Trading Day d , where “ t ” refers to a member of that set.

9.12. Network Control Service Calculations for a Trading Month

9.12.1. The Market Participant Network Control Service settlement amount for Market Participant p for Trading Month m is:

$$MPNCSA(p,m) = \text{Sum}(f \in F, n \in N, \text{Network Control Service Contract Payment}(p,m,f,n))$$

Where

Network Control Service Contract Payment (p,m,f,n) is the net payment to be made by the IMO under a Network Control Service Contract to Market Participant p , for Trading Month m for Registered Facility f as specified by the IMO under clause 5.9.1 which relates to Network Operator n ;

F is the set of all Market Participant p 's Registered Facilities, where “ f ” refers to a member of that set; and

Chapter 9

N is the set of all Network Operators, where “n” refers to a member of that set.

9.12.2. The Network Operator Network Control Service settlement amount for Network Operator n for Trading Month m is:

$$\text{NONCSA}(n,m) = \text{Sum}(p \in P, f \in F, \text{Network Control Service Contract Payment}(p,m,f,n))$$

This amount is a charge to Network Operators. See 9.14.2.

Where

Network Control Service Contract Payment(p,m,f,n) is the net payment to be made by the IMO under a Network Control Service Contract to Market Participant p, for Trading Month m for Registered Facility f which relates to Network Operator n as specified by the IMO under clause 5.9.1;

P is the set of all Market Participants, where “p” refers to a member of that set; and

F is the set of all Market Participant p’s Registered Facilities, where “f” refers to a member of that set.

9.13. The Market Participant Fee Settlement Calculations for a Trading Month

9.13.1. The applicable Market Participant Fee settlement amount for Market Participant p for Trading Month m is:

$$\begin{aligned} \text{MPFSA}(p,m) = & (\text{Market Fee rate} + \text{System Operation Fee rate} \\ & + \text{Regulator Fee rate}) \times \\ & (\text{Monthly Participant Load}(p,m) + \text{Monthly Participant Generation}(p,m)) \end{aligned}$$

Where

Market Fee rate is the charge per MWh for IMO’s services determined in accordance with clause 2.24.2 for the year in which Trading Month m falls;

System Operation Fee rate is the charge per MWh for System Management’s services determined in accordance with clause 2.24.2 for the year in which Trading Month m falls;

Regulator Fee rate is the charge per MWh for funding the Economic Regulation Authority’s activities with respect to the Wholesale Electricity Market determined in accordance with clause 2.24.2 for the year in which Trading Month m falls;

$$\text{Monthly Participant Load}(p,m) = (-1) \times \text{Sum}(d \in D, t \in T, \text{Metered Load}(p,d,t));$$

Metered Load will be a negative value so the (-1) is applied to produce a positive value.

Metered Load(p,d,t) for a Market Participant p for a Trading Interval t is the sum of the Metered Schedules for the Non-Dispatchable Loads, Dispatchable

Loads, Interruptible Loads and Curtailable Loads, registered to the Market Participant for Trading Interval t;

Monthly Participant Generation(p,m)
= Sum(d∈D,t∈T, Metered Generation(p,d,t)); and

Metered Generation(p,d,t) for Market Participant p for Trading Interval t is the sum of the Metered Schedules for Scheduled Generators and Non-Scheduled Generators, registered to the Market Participant for Trading Interval t;

D is the set of all Trading Days in Trading Month m, where “d” is used to refer to a member of that set;

T is the set of all Trading Intervals in Trading Day d, where “t” is used to refer to a member of that set.

9.14. The Net Non-STEM Settlement Amount for a Trading Month

9.14.1. The Net Monthly Non-STEM Settlement amount for the IMO to Market Participant p for Trading Month m is:

$$\text{NMNSSA}(p,m) = \text{RCSA}(p,m) + \text{Sum}(d, \text{BSA}(p,d,t)) + \text{ASSA}(p,m) \\ + \text{COCSA}(p,m) + \text{RSA}(p,m) + \text{MPNCSA}(p,m) + \text{MPFSA}(p,m)$$

9.14.2. The Net Monthly Network Operator Settlement Amount for the IMO to Network Operator n for Trading Month m

$$\text{NMNOSA}(n,m) = (-1) \times \text{NONCSA}(n,m)$$

Where NONSCA is defined in clause 9.12.2.

9.15. The Service Fee Settlement Amount for a Trading Month

9.15.1 The Service Fee Settlement amount for the IMO to party u in Trading Month m is:

$$\text{RRSA}(u,m) = k(u) \times \text{Sum}(p \in P, \text{MPFSA}(p,m))$$

Where

u indicates a member of the set comprising the IMO, System Management, or the Economic Regulation Authority;

k(u) is the proportionality factor for party u determined in accordance with clause 2.25.4

P is the set of all Market Participants, where “p” is used to refer to a member of that set; and

MPFSA(p,m) is the Market Participant Fee settlement amount for Market Participant P for Trading Month m.

There are no rules for settlement under market suspension. Instead, it is intended that the settlement regime be robust enough to produce a meaningful solution if there is no stem auction, no bilaterals submitted, etc.

Settlement Statements

The process by which the IMO conducts settlement is not intended to be reviewable.

9.16. Settlement Cycle Timelines

The aim of this section is to give the IMO the freedom to announce annually what the key dates are for all settlement cycles in that year.

The settlement process has been adjusted so that standard settlement statements and invoices go out on a regular basis (weekly for the STEM transactions, monthly otherwise) with participants raising Notices of Disagreements as required. However, instead of addressing changes stemming from those Notices of Disagreements (or disputes) as part of the normal settlement processes, a separate adjustment process is used.

An adjustment process is run at intervals to facilitate the incorporation of data changes into corrected settlement statements. Each adjustment process involves re-running the entire settlement process for a number of Trading Months in the past (for both STEM and Non-STEM transactions). This allows more time to raise Notices of Disagreement and ensures that when settlement changes are made, the corrections are reflected across the whole market.

Currently the rules assume at least 4 rounds of settlement corrections each year, but this could be expanded or reduced as required based on experience.

Comments were made within one of the Expert Teams suggesting that the settlement time for invoices should be extended from 2 days to a period of about 2 weeks so as to accommodate current invoicing practices of market participants. While this could be done, this change cannot be made without significant cost to participants. In particular:

- Required Credit Support would be increased. This is because the amount owed by Market Participants at any time will increase, and in the case of the STEM may increase by 2 to 3 fold. If the STEM is the main forum for trading then this will significantly increase the overall credit support required in the market.
- Currently Market Participants and the IMO settle within a few hours of each other. This minimises cash flow issues for Market Participants. If we move to a system that accommodates all existing participant settlement processes, then several days may need to elapse between participants paying the IMO what they owe it, and payments by the IMO to market participants. Market Participants will consequently face cash flow management issues.

Chapter 9

- If a Market Participant defaults, and inadequate credit support is posted or payment of credit support fails to materialise, then the potential default levy to be funded by market participants will be greater than it would have been otherwise.

Further, it is the normal practice in energy markets to settle invoices as quickly as possible, and 2 days is a period used in a number of markets internationally.

It is felt that rather than hastily changing the rules to reflect the Expert Teams comments, it is preferable to allow time for the market to digest the implications of such a change, and, if there is still interest in making a change, to make any required change prior to energy market commencement.

9.16.1. The settlement cycle timeline for the STEM is:

- (a) On the first Business Day commencing after the end of a Trading Week, the IMO must issue to each Market Participant participating in the STEM:
 - i. a STEM Settlement Statement for each of the Trading Days in the Trading Week; and
 - ii. an Invoice for the STEM Settlement Statements described in paragraph (i);

As commented in clause 9.1, the GST issues surrounding invoices will be explored once the IMO is established.

- (b) The STEM Settlement Date is the date upon which transactions covered by a STEM Settlement Statement are settled and is the second Business Day following the date of the Invoice described in paragraph (a)(ii) in relation to the STEM Settlement Statement is issued;
- (c) The STEM Settlement Disagreement Deadline is 5pm on the twentieth Business Day following the date the Invoice described in paragraph (a)(ii) in relation to the STEM Settlement Statement is issued. A Market Participant has until this time to lodge a Notice of Disagreement with the IMO pertaining to any amount included in the relevant STEM Settlement Statement.

Any corrections stemming from a disagreement will be addressed via the Settlement Adjustments described in clause 9.16.3.

9.16.2. The settlement cycle timeline for settlement of other amounts payable under these Market Rules for all Trading Days within a Financial Year must be published by the IMO at least one calendar month prior to the commencement of that Financial Year. This settlement cycle timeline must include for each settlement cycle:

- (a) The Interval Meter Deadline, being the Business Day by which meter data submissions for a Trading Month must be provided to the IMO. This date must be the first Business Day of the second month following the month in which the Trading Month commenced.

- (b) The Capacity Credit Allocation Submission timeline, including:
- i. the earliest date and time at which Capacity Credit Allocation Submissions for a Trading Month can be made, where this is to be a Business Day after the end of the Trading Month to which the Capacity Credit Allocation Submission relates but not less than 10 Business Days prior to the Non-STEM Settlement Statement Date;
 - ii. the latest date and time at which Capacity Credit Allocation Submissions for a Trading Month can be made to the IMO, where this is to be not less than five Business Days prior to the Non-STEM Settlement Statement Date;
 - iii. the time and date by which the IMO must contact any Market Participant identified under clause 9.4.9 where this is to be not less than four Business Days prior to the Non-STEM Settlement Statement Date;
 - iv. the time and date by which a Market Participant must respond to any request made by the IMO in accordance with clause 9.4.10 where this is to be not less than two Business Days prior to the Non-STEM Settlement Statement Date; and
 - v. the time and date by which the IMO will notify Market Participants from which the IMO has accepted Capacity Credit Allocation Submissions where this is to be not less than two Business Days prior to the Non-STEM Settlement Statement, but later than the time specified in (iv).
- (c) The Non-STEM Settlement Statement Date, being the Business Day by which Non-STEM Settlement Statements for a Trading Month must be issued by the IMO. This date must be not less than three Business Days and not more than five Business Days after meter data submissions are provided to the IMO.

<p>These timing rules ensure that meter data becomes available, then the Settlement Allocation deadline is reached, and then the Non-STEM Settlement Statement occurs.</p>
--

- (d) The Invoicing Date being the Business Day by which the IMO must issue Invoices for Non-STEM Settlement Statements for a Trading Month. This date must be the sixth Business Day of the second month following the month in which the Trading Month being settled commenced.
- (e) The Non-STEM Settlement Date being the Business Day on which the transactions covered by a Non-STEM Settlement Statement are settled. This date must be the eighth Business Day of the second month following the month in which the Trading Month being settled commenced.
- (f) The Non-STEM Settlement Disagreement Deadline, being 5:00pm on the twentieth Business Day following the date on which a Non-STEM Settlement Statement was issued. A Market Participant has until this time to lodge a

Chapter 9

Notice of Disagreement with the IMO in relation to any amount included in the Non-STEM Settlement Statement.

This date is a deadline for raising any disagreements. If they can be addressed in time for the Final Settlement Statement release, they will be included in that settlement run. If not, they will be addressed in a much latter settlement adjustment.

(g) [Blank]

9.16.3. The IMO must undertake a process for adjusting settlements (“**Adjustment Process**”) at least once every three months. The purpose of the process is to review the relevant Settlement Statements which were issued in the 12 months prior to the commencement of the Adjustment Process (“**Relevant Settlement Statements**”) to facilitate corrections resulting from Notices of Disagreement, the resolution of Disputes and revised metering data provided by Metering Data Agents. Adjustments may only be made to Relevant Settlement Statements. Adjustments may not be made to Settlement Statements outside of an Adjustment Process.

The 12 month limit is to place some finality on settlement statements. Under the current rules it is impossible to adjust settlement statements after a year has elapsed since the original statement was released.

9.16.4. The following dates for each Adjustment Process to be undertaken during a Financial Year must be published by the IMO at least one calendar month prior to the commencement of that Financial Year:

- (a) the commencement date for the settlement adjustment process,
- (b) the date by which adjusted STEM Settlement Statements and Non-STEM Settlement Statements will be released, where this must be not less than 20 Business Days after the date set for the purposes of paragraph (a);
- (c) the date by which Invoices reflecting the adjusted STEM Settlement Statements and Non-STEM Settlement Statements will be released, where this must be not less than two Business Days after the date set for the purposes of paragraph (b);
- (d) the settlement date for the Invoices described in paragraph (c), where this must be not less than two Business Days after the date set for the purposes of paragraph (c); and
- (e) subject to clause 9.19.7, the deadline for Notices of Disagreement pertaining to an adjusted Settlement Statement, where this must be not more than 20 Business Days after the adjusted Settlement Statement is released.

Clause 9.19.7 defines one adjusted settlement statement as final such that a Notice of Disagreement cannot be raised.

9.17. STEM Settlement Statements

This section assumes weekly settlement of STEM market transactions (i.e. on a different time frame from other market transactions). This will reduce prudential requirements for those participating in the STEM.

9.17.1. The IMO must provide STEM Settlement Statements to Market Participants in accordance with the settlement cycle timeline for the STEM.

9.17.2. A STEM Settlement Statement must include:

- (a) details of the Trading Day to which the STEM Settlement Statement relates;
- (b) details of the Market Participant to which the STEM Settlement Statement relates;
- (c) for each Trading Interval in the Trading Day to which the STEM Settlement Statement relates:
 - i. the STEM clearing Price;
 - ii. the STEM quantity scheduled for that Market Participant; and
 - iii. the STEM settlement amount for the Market Participant for the Trading Interval calculated in accordance with clause 9.6.1, where this may be a positive or negative amount.
- (d) the aggregate of the STEM settlement amounts calculated in accordance with clause 9.6.1 for the Market Participant for the Trading Day, where this may be a positive or negative amount;
- (e) whether the statement is an adjusted STEM Settlement Statement and replaces a previously issued STEM Settlement Statement;
- (f) in the case of an adjusted STEM Settlement Statement, details of all adjustments made relative to the first Non-STEM Settlement Statement issued for that Trading Month with an explanation of the reasons for the adjustments;
- (g) any interest applied in accordance with clause 9.1.3; and
- (h) [Blank]
- (i) all applicable taxes.

9.17.3. A STEM Market Participant may under clause 9.20 issue a Notice of Disagreement in respect of a STEM Settlement Statement by the STEM Settlement Disagreement Date.

9.18. Non-STEM Settlement Statements

The Non-STEM Settlement Statements provide Market Participants with a preliminary view of their settlement position (excluding the STEM). While they will be settled on this, there will be a subsequent adjustment as more accurate information becomes available.

There will be a single Non-STEM Settlement Statement for all Trading Days in a month. However, because meter data for generators and contestable loads will be available earlier than for non-contestable loads, some non-contestable load data will need to be estimated and corrected on a subsequent revised Non-STEM Settlement Statement.

9.18.1. The IMO must provide Non-STEM Settlement Statements to Market Participants in accordance with the settlement cycle timeline published under clause 9.16.2.

9.18.2. The IMO must provide a Non-STEM Settlement Statement to each:

- (a) Market Generator; and
- (b) Market Customer.

9.18.3. A Non-STEM Settlement Statement must contain the following information:

- (a) details of the Trading Days covered by the Non-STEM Settlement Statement;
- (b) details of the Market Participant to which the Non-STEM Settlement Statement relates;
- (c) for each Trading Interval of each Trading Day:
 - i. the Bilateral Contract quantities for each Market Participant;
 - ii. the Net Contract Position of the Market Participant;
 - ii(A). the MWh quantity of energy scheduled from each of the Market Participants Facilities;
 - iii. the energy scheduled to be provided in accordance with a Resource Plan data issued by, or applicable to, that Market Participant provided under clause 6.5;
 - iv. the Dispatch Schedule data for each of the Market Participant's Registered Facilities;
 - v. the meter reading for each Registered Facility associated with the Market Participant and to which paragraph (vii) is not applicable;
 - vi. in the case of the Electricity Generation Corporation, the total quantity of energy deemed to have been supplied by the Electricity Generation Corporation's Registered Facilities.

This will be based on operational meter data so will be a single figure for the entire company.

- vii. Notional Wholesale Meter values;

Chapter 9

This last clause relates to the Electricity Retail Corporation which will have a high proportion of its load estimated due to it not having interval meters.

- viii. the values of MCAP, UDAP, and DDAP;
- viii(A). in the case of the Electricity Generation Corporation the MWh quantity of non-compliance;
- ix. details of amounts calculated for the Market Participant under clauses 9.7 to 9.14 with respect to:
 - 1. Reserve Capacity settlement;
 - 2. Balancing settlement;
 - 3. Ancillary Services settlement
 - 4. Commitment and Outage Compensation settlement
 - 4A. Non-Compliance Cost settlement;
 - 5. Reconciliation settlement;
 - 6. Network Control Service settlement; and
 - 7. Fee settlement; and
 - 8. Net Monthly Non-STEM Settlement Amount;
- x. details of any Capacity Credits allocated to the Market Participant in a Capacity Credit Allocation Statement made by another Market Participant in accordance with clauses 9.4 and 9.5;
- xi. details of any Capacity Credits allocated to another Market Participant in a Capacity Credit Allocation Submission made by the Market Participant in accordance with clauses 9.4 and 9.5;
- xii. details of any reductions in payments in the preceding Trading Month under clause 9.24.3 as a result of a Market Participant being in Default;
- xiii. details of any payments to the Market Participant as a result of the IMO recovering funds not paid to the Market Participant in previous Trading Months under clause 9.24.3 as a result of a Market Participant being in Default;
- xiv. in regard to Default Levy re-allocations, as defined in accordance with clause 9.24.9:
 - 1. the total amount of Default Levy paid by that Market Participant during the Financial Year, with supporting calculations;
 - 2. the adjusted allocation of those Default Levies to be paid by that Market Participant, with supporting calculations; and
 - 3. the net adjustment be made;

- (d) whether the statement is an adjusted Non-STEM Settlement Statement and replaces a previously issued Non-STEM Settlement Statement;
- (e) in the case of an adjusted Non-STEM Settlement Statement, details of all adjustments made relative to the first Non-STEM Settlement Statement issued for that Trading Month with an explanation of the reasons for the adjustments;
- (f) any interest applied in accordance with clause 9.1.3;
- (g) the net dollar amount owed by the Market Participant to the IMO for the billing period (i.e. the Trading Days covered by the Non-STEM Settlement Statement) where this may be a positive or negative amount; and
- (h) all applicable taxes.

9.18.4. A Market Participant may under clause 9.20 issue a Notice of Disagreement in respect of a Non-STEM Settlement Statement by the Non-STEM Settlement Disagreement Deadline.

9.19. Adjusted Settlement Statements

9.19.1. When undertaking an Adjustment Process the IMO must:

- (a) recalculate the amounts included in the Relevant Settlement Statements in accordance with this Chapter but taking into account any:
 - i. revised metering data which has been provided by Metering Data Agents;
 - ii. actions arising from a Notice of Disagreement; and
 - iii. the resolution of any Dispute; and
- (b) provide adjusted STEM Settlement Statements and adjusted Non-STEM Settlement Statements to Rule Participants in accordance with the timeline specified under clause 9.16.4 in respect of the relevant Adjustment Process.

9.19.2. Subject to clause 9.19.3, an adjusted Settlement Statement must be in the same form as the original Settlement Statement, but where data is modified between the issuance of the original Settlement Statement and the adjusted Settlement Statement, the IMO must record both values and provide an explanation of the change.

9.19.3. An adjusted Settlement Statement must include details of the adjustment to be paid by or to the Market Participant, being:

- (a) the adjustment which will need to be paid by or to the Market Participant to put the Market Participant in the position it would have been in at the time payment was made in respect of the original Settlement Statement if the adjusted Settlement Statement had been issued as the original Settlement

Chapter 9

Statement (but taking into account any adjustments previously made under this clause 9.19); plus

- (b) interest on the amount referred to in paragraph (a) calculated in accordance with clause 9.1.3.

The Adjustment Amount is positive if the adjustment is in favour of the Market Participant and negative if the adjustment is in favour of the IMO.

The convention used in the settlement calculations is that a positive amount is in favour of the Market Participant.

9.19.4. In recalculating amounts as part of an Adjustment Process, the IMO may use the version of the settlement calculation software current at the time of the recalculation.

9.19.5. A Rule Participant may under clause 9.20 issue a Notice of Disagreement in respect of an adjusted Settlement Statement by the deadline specified under clauses 9.16.4(e) in respect of the relevant Adjustment Process.

9.19.6. Subject to clause 9.19.7, a Rule Participant may only issue a Notice of Disagreement for an adjusted Settlement Statement with respect to information in the adjusted Settlement Statement which differs from information in the previously released version of that Settlement Statement and which has not been changed in accordance with the resolution of a Notice of Disagreement issued by the relevant Market Participant or a Dispute in relation to which the relevant Market Participant was a Dispute Participant.

9.19.7. A Notice of Disagreement with respect to an adjusted Settlement Statement may not be issued more than nine months after the issuance of the original Settlement Statement.

The following points summarise the settlement adjustment timelines.

The following points summarise the settlement adjustment timelines.

- original settlement statement issued
- few days exist to raise initial disagreement
- once the disagreement is resolved (which should be within 3 months) that data will go into the next Settlement Adjustment process (which cannot be more than 3 months later)
- Hence the issue should have been factored into a Settlement Adjustment within 6 months.
- While you can disagree with an adjusted settlement statement ,this must be done within 9 Months.

- The IMO has until basically 1 year after the event to address the adjustments settlement statement dispute.
- Separately, disputes can be raised after one round of disagreement but no adjustments will be made for adjustments stemming from events more than 12 months prior to the date of adjustment.

9.20. Notices of Disagreement

9.20.1. A Notice of Disagreement must be in writing and may be mailed, sent by facsimile or e-mailed to the IMO.

9.20.2. Upon receipt of a Notice of Disagreement, the IMO must confirm receipt within one Business Day by facsimile or e-mail.

9.20.3. If a Rule Participant fails to receive a confirmation in accordance with clause 9.20.2, then it must contact the IMO within one Business Day of the deadline for receipt of the confirmation described in clause 9.20.2 to appraise the IMO of the failure of the IMO to confirm receipt and, if necessary, to make alternative arrangements for the submission of the Notice of Disagreement.

9.20.4. A Notice of Disagreement must include:

- (a) details of the Settlement Statement and Trading Day to which the Notice of Disagreement relates;
- (b) details of the Rule Participant to which the Notice of Disagreement relates; and
- (c) a list of information in the Settlement Statement with which the Market Participant disagrees, including:
 - i. the reason for the disagreement; and
 - ii. what the Rule Participant believes the correct value should be, if this is known.

9.20.5. If a Notice of Disagreement relates to information provided to the IMO by a Metering Data Agent or System Management then as soon as practical, but not later than five Business Days after the IMO confirms receipt of the Notice of Disagreement, the IMO must;

- (a) notify the Metering Data Agent or System Management (as applicable) of any item of information provided by them to which the Notice of Disagreement relates;
- (b) notify the Metering Data Agent or System Management (as applicable) of the time and date by which the IMO requires a response, where the date is to be no later than 60 days after the date on which the IMO confirmed receipt of the Notice of Disagreement; and

- (c) require the Metering Data Agent or System Management (as applicable) to investigate the accuracy of the item and to provide a response by the time specified under paragraph (b):
 - i. reporting on the actions taken to investigate the accuracy of the item; and
 - ii. if applicable, a revised value for the item, which may be a revised value, that the Metering Data Agent or System Management (as applicable) considers to be in compliance with these Market Rules and accurate.

9.20.6. If a Notice of Disagreement relates to any item of information developed by the IMO, then:

- (a) if the information relates to values that are inputs to the settlement process the IMO must determine a value for the item, which may be revised value, that it considers to be in compliance with these Market Rules and accurate;
- (b) if the information relates to values that are outputs to the settlement process the IMO must review its settlement calculations and assess whether any errors were made.

9.20.7. The IMO must, as soon as practical, but within three months of confirming receipt of a Notice of Disagreement respond to a Market Participant who issued a Notice of Disagreement indicating the actions (if any) the IMO will take in response to the Notice of Disagreement, where such actions may include:

- (a) revising information provided to the IMO by Metering Data Agents and System Management (as applicable), and the reasons provided to the IMO for those revisions, in accordance with clause 9.20.5;
- (b) revising information developed by the IMO and used as an input to the settlement process, and the reason for the revision, as determined in accordance with clause 9.20.6; and
- (c) whether the IMO considers an error was made in the settlement calculations that has produced an incorrect Settlement Statement.

9.20.8. If a Market Participant is not satisfied with the IMO's response to a Notice of Disagreement given by the Market Participant, it may issue a Notice of Dispute to the IMO in accordance with clause 9.21.

9.21. Settlement Disputes

9.21.1. A Market Participant may only issue a Notice of Dispute in regard to a Settlement Statement after:

- (a) having raised a Notice of Disagreement with respect to a Settlement Statement; and

- (b) the IMO having given a response under clause 9.20.7 in respect of the Notice of Disagreement with which the Market Participant is not satisfied.

Invoicing and Payment

9.22. Invoicing and Payment

9.22.1. Invoices must be issued to Rule Participants by the IMO in accordance with the timelines specified under clauses 9.16.1, 9.16.2, and 9.16.4.

9.22.2. An Invoice must include:

- (a) all Settlement Statements (including adjusted Settlement Statements) to which the Invoice relates;
- (b) the net amount to be paid to or by the IMO (including applicable taxes). A positive amount is to be paid by the Market Participant to the IMO and a negative amount is to be paid by the IMO to the Market Participant;
- (c) the payment date and time; and
- (d) any amounts outstanding from overdue payments in relation to previous Settlement Statements.

9.22.3. The IMO must maintain an account with an institution that meets either of the requirements specified in clause 2.38.6(a) for the sole purpose of settling market transactions, where this account is to be maintained at a branch of the institution located in Western Australia.

9.22.4. The IMO must nominate that an electronic funds transfer (“EFT”) facility is to be used by all Market Participants and Rule Participants for the purpose of some or all settlements under these Market Rules.

The intention is to use a system like Austraclear (though not necessarily Austraclear). Austraclear is an arrangement between banks and the Reserve Bank of Australia to facilitate automatic cash transactions in the NEM. The use of such a system removes the need for Market Participants to notify the IMO of their bank account details.

9.22.5. Unless otherwise authorised by the IMO, all Rule Participants must use the EFT facility nominated by the IMO under clause 9.22.4 for the purpose of settlements under these Market Rules and the payment of Market Participant Fees to the IMO to the extent nominated by the IMO.

9.22.6. If an Invoice indicates that a Rule Participant owes an amount to the IMO, then the Rule Participant must pay the full amount to the IMO (in cleared funds) by 10 AM on the date specified in the Invoice in accordance with clause 9.16.1(b), 9.16.2(e), and 9.16.4(d) (as applicable), whether or not it disputes the amount indicated to be payable.

Chapter 9

The clause 9.16.1(b) pertains to weekly STEM settlement, clause 9.16.2(e) to monthly non-STEM settlement, and clause 9.16.4(d) pertains to periodic settlement adjustments. Note that the IMO could choose to align the adjusted STEM settlement date with the date of a normal monthly STEM settlement.

9.22.7. Late payments by Market Participants accrue interest calculated in accordance with clause 9.1.3.

9.22.8. If an Invoice indicates that the IMO owes an amount to a Rule Participant, then the IMO must pay the full amount to the Rule Participant (in cleared funds) by 2 PM on the date specified in the Invoice in accordance with clause 9.16.1(b), 9.16.2(e), and 9.16.4(d) (as applicable), except as provided for in clause 9.24.

9.22.9. The IMO must establish, in its books, a separate fund in which it will credit all Service Fee Settlement Amounts payable to the IMO under these Market Rules.

9.22.10. The Service Fee Settlement Amount owing to the IMO will be taken to have been paid when it is transferred into the account established by the IMO for the purpose of meeting its obligations under clause 9.22.9.

9.22.11. The IMO may apply money from the fund established under clause 9.22.9 to meet the costs incurred in carrying out its functions or obligations under these Market Rules and performing the services contemplated by clause 2.22.1 or in connection with doing so.

Default and Settlement in Default Situations

9.23. Default

Note that the IMO can, under clause 2.41.4, notify a Market Participant of its Trading Margin at any time, which provides the IMO the capability to warn Market Participants that they are approaching a situation where a Margin Call may be given, before that situation is reached. This approach is used in the National Electricity Market and has been used to informally remedy situations before a Margin Call is required.

9.23.1. For the purposes of these Market Rules, a “suspension event” occurs in relation to a Market Participant if:

- (a) the Market Participant fails to make a payment under these Market Rules before the time it is due;
- (b) the Market Participant is in breach of a Prudential Obligation;
- (c) the IMO has drawn on a Credit Support in relation to the Market Participant and payment under the Credit Support is not received by the IMO within 90 minutes of being requested;

- (d) it is unlawful for the Market Participant to comply with any of its obligations under the Market Rules or any other obligation owed to the IMO or the Market Participant claims that it is unlawful for it to do so;
- (e) it is unlawful for a provider of Credit Support in relation to the Market Participant to comply with any of its obligations under the Credit Support or any other obligation owed to the IMO or the provider claims that it is unlawful for it to do so;
- (f) an authorisation from a government body necessary to enable the Market Participant to carry on a business or activity related to its participation in the Wholesale Electricity Market ceases to be in full force and effect;
- (g) an authorisation from a government body necessary for the provider of Credit Support in relation to the Market Participant to carry on the business of providing credit support ceases to be in full force and effect;
- (h) the Market Participant ceases or threatens to cease to carry on its business or a substantial part of its business related to its participation in the Wholesale Electricity Market;
- (i) the provider of credit support in relation to the Market Participant ceases or threatens to cease to carry on its business of providing credit support;
- (j) the Market Participant is insolvent within the meaning of clause 9.23.2;
- (k) a provider of Credit Support in relation to the Market Participant is insolvent within the meaning of clause 9.23.2;
- (l) a resolution is passed or any steps are taken to pass a resolution for the winding up or dissolution of the Market Participant or a provider of Credit Support in relation to that Market Participant;
- (m) the Market Participant or a provider of Credit Support in relation to the Market Participant is dissolved.

9.23.2. A person is insolvent for the purposes of clause 9.23.1 if :

- (a) the person states that it is insolvent or insolvent under administration (each as defined in the Corporations Act) or that it is unable to pay from its own money its debts when they fall due for payment;
- (b) the person is protected from creditors under any statute or enters into an arrangement (including a scheme of arrangement), composition or compromise with, or assignment for the benefit of, all or any class of its creditors or members or a moratorium involving any of them;
- (c) an application or order for winding up or dissolution is made in respect of the person;
- (d) a controller (as defined in the Corporations Act), administrator, provisional liquidator, liquidator, trustee in bankruptcy or person having a similar or

Chapter 9

analogous function under the laws of any relevant jurisdiction is appointed in respect of the person or any of the person's property (as the case may be);

- (e) the person is taken to be unable to pay its debts when they fall due for payment under any applicable legislation;
- (f) any action is taken by, or in connection with, the person which is preparatory to, or could result in, any of the events described in paragraphs (b), (c), (d) or (e) above;
- (g) the person is the subject of an event described in section 459C(2) or section 585 of the Corporations Act (or the person makes a statement from which the IMO reasonably deduces the person is so subject); or
- (h) notice under section 601AB(3) of the Corporations Act is given in relation to the person.

9.23.3. If a Rule Participant becomes aware that a suspension event has occurred in relation to it, then the Rule Participant must promptly notify the IMO, giving full details of the event.

9.23.4. If the IMO becomes aware that a suspension event has occurred in relation to a Rule Participant, then the IMO must as soon as practicable:

- (a) subject to clause 9.23.5, issue a notice ("**Cure Notice**"), requiring that the default be remedied within 24 hours from the time the Cure Notice is issued; and
- (b) if it has not already done so, draw upon Credit Support held in relation to that Market Participant for the amount which the IMO determines is actually or contingently owing by the Market Participant to the IMO under these Market Rules.

Drawing upon Credit Support will reduce the ability of the Market Participant to trade in the market. The intention is that the **Electricity Retail Corporation** will be the **retailer** of last resort.

9.23.5. Where the IMO has given a Cure Notice to a Market Participant in respect of a suspension event described in clause 9.23.1(a) or (b), the IMO may extend the deadline for remedying the suspension event by up to five Business Days from the date on which the suspension event occurred if the IMO considers that:

- (a) the Market Participant can pay all outstanding amounts, and comply in full with the Prudential Obligations, before the end of the extended deadline; and
- (b) the Market Participant is not capable of doing so within the 24 hours following the issuance of the Cure Notice

9.23.6. Where the IMO has given a Cure Notice to a Market Participant in respect of a suspension event described in any of clauses 9.23.1(c) to (m), the IMO may extend

the deadline for remedying the suspension event for such period as the IMO considers appropriate if the IMO considers that:

- (c) the Market Participant will be able to remedy the suspension event before the end of the extended deadline; and
- (d) the Market Participant is not capable of doing so within the 24 hours following the issuance of the Cure Notice

9.23.7. If a Market Participant does not remedy a suspension event before the deadline specified in clause 9.23.4(a) (as extended, if applicable, under clause 9.23.5 or 9.23.6), then the IMO may issue a Suspension Notice to the relevant Market Participant in which case clause 2.32 applies.

9.24. Settlement in Default Situations

Default is unlikely to occur, and most energy will be traded bilaterally, so it has been decided for simplicity to adopt a similar approach to the NEM whereby settlement payments are reduced in the first instance, and made up later as funds become available. This reduction will be shared across all market participants in proportion to metered quantities.

9.24.1. In the event that a Market Participant fails to make a payment under these Market Rules to the IMO before it is due, then the IMO may draw upon any Credit Support in relation to that Market Participant to meet the payment.

9.24.2. If, under Part 5.7B of the Corporations Act or another law relating to insolvency or the protection of creditors or similar matters, the IMO is required to disgorge or repay an amount, or pay an amount equivalent to an amount, paid by a Market Participant under the Market Rules:

- (a) the IMO may draw upon any Credit Support held by the IMO in relation to the Market Participant for the amount disgorged, repaid or paid (“**Repaid Amount**”); and
- (b) if the IMO is not able to recover all or part of the Repaid Amount by drawing upon Credit Support held by the IMO in relation to the Market Participant, then the IMO must take the Repaid Amount into account the next time it calculates the Reconciliation Settlement amount under clause 9.11.1 as if it was a positive Balancing Settlement Amount for a Market Participant for a Trading Day during the relevant Trading Month.

Market Participants at the time of the disgorgement are the ones who pay, rather than those at the time of the initial payment. This is to make it consistent with the note below and make sure the IMO is not exposed.

Consider an example as to how disgorgement could arise. If Rule Participant A owes an amount to the IMO and pays that amount when it is insolvent, then the IMO is potentially liable to repay that amount if the Rule Participant goes into administration or is wound up

Chapter 9

within six months and the payment results in the IMO receiving more than it would in the winding-up of Rule Participant A. The IMO is potentially liable regardless of whether it has knowledge as to the financial state of Rule Participant A.

The timing issue is that were this to occur, the Market Participants required to fund this disgorgement may be a different set of Market Participants that existed at the time that the IMO first was informally notified of the insolvency. Thus there is an equity problem.

There are no simple options for addressing the risk of disgorgement or addressing the equity issue, and hence the rules have been left in a form which leaves the risk with those who happen to be Market Participants at the time of the disgorgement.

9.24.3. Notwithstanding anything else in these Market Rules, if at any time the total amount received by the IMO from Rule Participants in cleared funds (“**Total Amount**”) is not sufficient to make the payments which the IMO is required to make under these Market Rules (for example, as a result of default by one or more Rule Participants), then the IMO’s liability to make those payments is limited to the Total Amount. The IMO must apply the Total Amount as follows:

- (a) first, the IMO must apply the Total Amount to satisfy:
 - i. payment of Revenue Requirement Settlement Amounts to the IMO, System Management and the Economic Regulation Authority (including as contemplated by clause 9.22.10);
 - ii. payments which the IMO is required to make under Supplementary Capacity Contracts or to a provider of Ancillary Services holding an Ancillary Service Contract with System Management; and
 - iii. payments which the IMO is required to make under Network Control Service Contracts; and

Clause (i) relates to payments required to support the operation of the market while clauses (ii) and (iii) relate to payments to parties that are not market participants, which the IMO will legally be obliged to make.

- iv. funds required to be disgorged or repaid by the IMO as contemplated by clause 9.24.2; and
- (b) second, it must apply the remainder to pay amounts which, but for this clause 9.24.3(b), it would owe to Rule Participants in accordance with clause 9.22, where those amounts are reduced by applying the following formula:

$$AAP = (NAP / TNAP) \times MAA$$

where:

AAP is the reduced amount actually payable by the IMO to a Rule Participant in respect of the relevant Trading Week, in the case of an Invoice relating to a STEM Settlement Statement, and the relevant

Trading Month, in the case of an Invoice relating to a Non-STEM Settlement Statement;

NAP is the net amount that would have been payable by the IMO to the Rule Participant, but for the application of this clause 9.24.3(b), in respect of the relevant Trading Week or Trading Month (as applicable);

TNAP is the total net amount payable by the IMO to all Rule Participants, but for the application of this clause 9.24.3(b), in respect of the relevant Trading Week or Trading Month (as applicable), calculated by summing all values of NAP; and

MAA is the remainder of the Total Amount available for payment by the IMO after the application of paragraph (a).

In the case of a major default, or a series of major defaults, there is a (remote) potential for the IMO to still be out of pocket.

9.24.4. If one or more Market Participants have suffered a reduction under clause 9.24.3(b) as a result of a Payment Default and, within five Business Days of the Payment Default, the IMO has received full or partial payment of the overdue amount, then the IMO must within one Business Day pay the amount received (including any interest paid under clause 9.22.7 in respect of the Payment Default) on a pro-rata basis to all Market Participants who suffered a reduction. The amount to be paid to each Market Participant is determined by applying the formula in clause 9.24.3(b), but as if AAP referred to the amount to be paid to each Market Participant, MAA referred to the amount of the full or partial payment, and NAP and TNAP have the same value as when the reduction was calculated.

9.24.5. If, five Business Days after a Payment Default, the IMO is yet to recover in full the overdue amount, then it must raise a Default Levy from all Market Participants (other than the Market Participant which committed the Payment Default) to cover the remaining shortfall (including interest calculated in accordance with clause 9.22.7). The amount to be paid by each Market Participant is to be determined by the IMO. In determining the amount to be paid by a Market Participant, the IMO must have regard to the absolute value of the MWh of generation or consumption, determined in accordance with the Metered Schedules, for each Market Participant for Trading Intervals during the preceding Trading Month, as a proportion of the total of those values for all Market Participants.

Note that while default levies are collected from everyone, they may not be paid out to the same people (e.g. because most people are trading under bilateral contracts). Were this not the case then interest described in clause 9.24.5 would not need to be applied as we would be collecting interest from those who will then be paid that interest. However, given the parties are different, interest is included.

Chapter 9

9.24.6. The IMO must notify each Market Participant of the amount it must pay in respect of the Default Levy as determined in accordance with clause 9.24.5 within six Business Days of the Payment Default occurring.

9.24.7. A Market Participant must pay the full amount notified by the IMO under clause 9.24.6 to the IMO (in cleared funds) by 10 AM of the 8th Business Day following the date of the Payment Default, whether or not it disputes the amount notified.

9.24.8. By 2 PM on the 8th Business Day following the date of a Payment Default, the IMO is to allocate the total of the Default Levy amounts received under clause 9.24.7 on a pro-rata basis to all Market Participants who suffered a reduction under clause 9.24.3(b) as a result of the Payment Default. The amount to be paid to each Market Participant is determined by applying the formula in clause 9.24.3(b), but as if AAP referred to the amount to be paid to each Market Participant, MAA referred to the total amount actually received under clause 9.24.7 and NAP and TNAP have the same value as when the reduction was calculated.

Which provided no one has defaulted in paying the default levy should result in full payment to all non-defaulting participants.

9.24.9. Upon completion of the final Trading Month commencing during a Financial Year, the IMO must re-allocate any Default Levies raised during that Financial Year as follows:

- (a) the IMO will determine the aggregate of the shortfalls in respect of which it raised Default Levies during the Financial Year less any subsequent amounts recovered and refunded under clause 9.24.10;
- (b) the IMO will determine the aggregate Default Levy amount which should have been paid by each Market Participant, having regard to the absolute value of the MWh of generation or consumption, as determined in accordance with the Metered Schedules for each Market Participant for Trading Intervals during the Financial Year as a proportion of the total of those values for all Market Participants;
- (c) the IMO must compare the amount determined for the Market Participant under paragraph (b) with the total of the amounts which the Market Participant actually paid under clause 9.24.7;
- (d) the IMO must determine an appropriate adjustment to put each Market Participant in the position it would have been in had it paid the amount determined under paragraph (b) instead of the amounts actually paid under clause 9.24.7; and
- (e) include that adjustment in the Non-STEM Settlement Statement for the most recently completed Trading Month.

9.24.10. If, after raising a Default Levy in respect of a Payment Default in accordance with clause 9.24.5, the IMO recovers all or part of the relevant shortfall from the

defaulting Market Participant, then it must use the amount recovered to refund Default Levy amounts paid under clause 9.24.7 in respect of the Payment Default as soon as practical but not later than the end of the calendar month following the month in which the amount is recovered. The IMO will determine the amount to be refunded to each Market Participant which paid a Default Levy amount under clause 9.24.7 in respect of the Payment Default (as adjusted, if applicable, under clause 9.24.9). In determining the amount to be refunded to a Market Participant, the IMO must have regard to:

- (a) the amount recovered; and
- (b) the Default Levy amount paid by the Market Participant under clause 9.24.7 (as adjusted, if applicable, under clause 9.24.9) as a proportion of the total of those amounts paid by all Market Participants.

10 Market Information

Information Policy

10.1. Record Retention

10.1.1. The IMO must develop and publish a list of all information and documents that relate to the Wholesale Electricity Market activities that Rule Participants must retain.

10.1.2. Effective from the date that the IMO publishes a list containing the relevant information or document, Rule Participants must retain any information or documents of that kind for a period of seven years from the date it is created, or such longer period as may be required by law.

10.2. Information Confidentiality Status

10.2.1. The IMO must, in accordance with the Market Rules and Market Procedures, set and publish the confidentiality status for each type of market related information and document produced or exchanged in accordance with the Market Rules or Market Procedures.

10.2.2. The classes of confidentiality status are:

- (a) Public, in which case the relevant information or documents may be made available to any person by any person;
- (b) SWIS Restricted, in which case the relevant information or documents may only be made available to:
 - i. Rule Participants;
 - ii. the Market Advisory Committee;
 - iii. the IMO;
 - iv. the Energy Review Board;
 - v. the Economic Regulation Authority; and
 - vi. other Regulatory or Government Agencies in accord with applicable laws;
- (c) Rule Participant Market Restricted, in which case the relevant information or documents may only be made available to:
 - i. a specific Rule Participant;
 - ii. the IMO;
 - iii. the Energy Review Board;
 - iv. the Economic Regulation Authority; and

- v. other Regulatory or Government Agencies in accord with applicable laws;
- (d) Rule Participant Dispatch Restricted, in which case the relevant information or documents may only be made available to:
 - i. a specific Rule Participant;
 - ii. System Management
 - iii. the IMO;
 - iv. the Energy Review Board;
 - v. the Economic Regulation Authority; and
 - vi. other Regulatory or Government Agencies in accord with applicable laws;
- (e) System Management Confidential, in which case the relevant information or documents may only be made available to:
 - i. System Management;
 - ii. the IMO;
 - iii. the Energy Review Board;
 - iv. the Economic Regulation Authority; and
 - v. other Regulatory or Government Agencies in accord with applicable laws; and
- (f) IMO Confidential, in which case the relevant information or documents may only be made available to:
 - i. the IMO;
 - ii. the Energy Review Board;
 - iii. the Economic Regulation Authority; and
 - iv. other Regulatory or Government Agencies in accord with applicable laws.

10.2.3. In setting the confidentiality status of a type of market related information or document under clause 10.2.1, the IMO must have regard to the following principles:

- (a) commercially sensitive or potentially defamatory information pertaining to a Rule Participant is not made public or revealed to other Rule Participants except in accordance with legal requirements or requirements of these Market Rules;
- (b) subject to paragraph (a), Rule Participants are to have access to information pertaining to current and expected future conditions of the power system that may impact on their ability to trade, deliver, or consume energy;

Chapter 10

- (c) the IMO can make available to a person information if the IMO is required to do so by law or these Market Rules;
- (d) the IMO can restrict the availability of information to a person where this is required by law, or these Market Rules;
- (e) the IMO can declare incomplete working documents to be IMO Confidential;
- (f) the IMO can declare incomplete working documents of System Management to be System Management Confidential; and
- (g) subject to this clause 10.2.3, the confidentiality status must maximise the number of parties that may view the information or document.

10.2.4. Subject to clauses 10.2.5, 10.2.6 and 10.4.1, a Rule Participant must not provide information or documents of a given confidentiality status to any person.

10.2.5. Clause 10.2.4 does not apply to information or documents:

- (a) in the public domain;
- (b) already known to the person receiving it;
- (c) required to be provided by law or a stock exchange having jurisdiction over the Rule Participant; or
- (d) required in connection with resolving a dispute.

10.2.6. A Rule Participant may disclose information or a document to:

- (a) any person (including another Rule Participant) where the confidentiality status of the information or document is set as Public by the IMO under clause 10.2.1;
- (b) any other Rule Participant where the confidentiality status of the information or document is set as SWIS Restricted by the IMO under clause 10.2.1;
- (c) the specific Rule Participant able to receive the information or document in accordance with the confidentiality status, where the confidentiality status of the information or document is set as either Rule Participant Market Restricted or Rule Participant Dispatch Restricted by the IMO under clause 10.2.1; or
- (d) a Representative of the Rule Participant or a Representative of any person able to receive the information or document under paragraphs (a), (b) or (c).

10.3. The Market Web Site

10.3.1. The IMO must maintain a Market Web Site for the purpose of:

- (a) providing information on the nature and operation of the market;
- (b) providing information on market performance; and
- (c) disseminating reports and documents.

Chapter 10

10.3.2. Subject to clause 10.4.2, the IMO must not require a fee for information or documents released by the IMO via the Market Web Site.

10.3.3. Where these Market Rules require System Management to provide information and documents to the IMO to be published on the Market Web Site, and the IMO is not required to approve or alter such information or documents, then, with System Management's agreement, the IMO may delegate to System Management the authority to directly post such information or documents on the Market Web Site. The IMO retains the right to cancel such delegation without consultation with System Management.

10.3.4. Where the IMO allows System Management to post information or documents on the Market Web Site in accordance with clause 10.3.3 the IMO's obligation under these Market Rules to publish such information or documents will transfer to System Management.

10.3.5. The IMO must document the protocols by which System Management and the IMO can change the Market Web Site in a Market Procedure and the IMO and System Management must comply with that documented Market Procedure in respect of changing the Market Web Site.

10.4. Information to be Released on Application

10.4.1. The IMO must make information and documents available on application by any person subject to that person being a member of the class of persons able to receive information or documents in accordance with the relevant confidentiality status.

10.4.2. The IMO may charge a person a fee for providing information or documents provided in accordance with clause 10.4.1, where that fee may not exceed the IMO's costs, not otherwise included in the IMO's budget, of:

- (a) collating and transmission of information or documents; and
- (b) preparing documents not otherwise required by the Market Rules, applicable law or regulation.

Information to be Released via the Market Web Site

The complexity of the IMO's web site and systems can be reduced by removing some data from the website and disseminating it by other means (e.g. on request and via e-mail etc). This would relate mainly to the data that is specified for each Trading Interval. Alternatively this data could just be uploaded to the website less often - perhaps once a week, or once a month, rather than on the day following each Trading Day.

10.5. Public Information

10.5.1. The IMO must set the class of confidentiality status for the following information under clause 10.2.1, as Public and the IMO must make each item of information available from the Market Web-Site after that item of information becomes available to the IMO:

- (a) the following Market Rule and Market Procedure information and documents:
 - i. information on the records that must be maintained by Rule Participants;
 - ii. the list of the confidentiality status of information and documents pertaining to the Wholesale Electricity Market developed by the IMO in accordance with clause 10.2.1;
 - iii. the current version of the Market Rules;
 - iv. information on any Amending Market Rules that have been made in accordance with the Rule Change Process but are yet to commence or to be included in the current version of the Market Rules, including the date those Amending Rules will take affect;
 - v. any Rule Change Proposals that are open to public comment;
 - vi. the current version of Market Procedures;
 - vii. information on any changes to any Market Procedures that have been made in accordance with the Procedure Change Process but are yet to commence or to be included in the current version of the applicable Market Procedure, including the date those Market Procedure changes will take affect;
 - viii. any Procedure Change Proposals that are open to public comment; and
 - ix. a document summarising all Rule Change Proposals and Procedure Change Proposals that are no longer open to public comment and whether or not those proposals were accepted or rejected;

The purpose of this document is to provide a reference to all previous Market Rule and Procedure change proposals so that anyone wishing to propose a change can quickly determine if there has been any attempt to make that change in the past.

- (b) instructions as to how to initiate a Rule Change Process and Procedure Change Process.
- (c) details of all Rule Participants including:
 - i. name;
 - ii. mailing address, telephone and facsimile number;
 - iii. the name and title of a contact person;

- iv. details of applicable licenses held;
 - v. applicable Rule Participant classes;
 - vi. applicable Market Participant classes; and
 - vii. names and capacities of Registered Facilities;
- (d) the precise basis for determining the Bank Bill Rate;
- (e) details of bid, offer and clearing price limits as approved by the Economic Regulation Authority including:
- i. the Maximum Reserve Capacity Price;
 - ii. the Maximum STEM Price;
 - iii. the Alternative Maximum STEM Price;
 - iv. the Minimum STEM Price; and
 - v. the Maximum Shutdown Price,
- including rules that could cause different values to apply at different times;

STEM Bid and STEM Offer prices are limited by the Maximum, Alternative Maximum and Minimum STEM Prices. These also limit the maximum STEM Clearing Price and MCAP, UDAP and DDAP.

- (f) the following Reserve Capacity information (if applicable):
- i. Requests for Expressions of Interest described in clause 4.2.3 for the previous five Reserve Capacity Cycles;
 - ii. the summary of Requests for Expressions of Interest described in clause 4.2.7 for the previous five Reserve Capacity Cycles;
 - iii. the Reserve Capacity Information Pack published in accordance with clause 4.7.2 for the previous five Reserve Capacity Cycles;
 - iv. the total amount of Capacity Credits held by each supplier of Capacity Credits;
 - v. the identity of each Market Participant from which the IMO procured Capacity Credits in the most recent Reserve Capacity Auction, and the total amount procured, where this information is to be published by January 7th of the year following the Reserve Capacity Auction;
 - vi. for each Special Price Arrangement for each Registered Facility:
 - 1. the amount of Reserve Capacity covered;
 - 2. the term of the Special Price Arrangement; and
 - 3. the Special Reserve Capacity Price applicable to the Special Price Arrangement,

where this information is to be current as at, and published on, January 7th of each year;

- vii. all Reserve Capacity Offer quantities and prices, including details of the bidder and facility, for a Reserve Capacity Auction, where this information is to be published by January 7th of the year following the Reserve Capacity Auction; and
 - viii. reports summarising facility tests and reasons for delays in those tests, as required by clause 4.25.11.
- (g) the Ancillary Service report referred to in clause 3.11.11B;
- (h) for each Trading Interval in each completed Trading Day in the previous 12 calendar months:
- i. the sum of the Metered Schedule generation for Scheduled Generators and Non-Scheduled Generators registered to **the Electricity Generation Corporation**;
 - ii. the sum of the Metered Schedule generation for Scheduled Generators and Non-Scheduled Generators registered to Market Participants other than **the Electricity Generation Corporation**; and
 - iii. the sum of the Resource Plan schedule generation for Scheduled Generators and Non-Scheduled Generators registered to Market Participants other than **the Electricity Generation Corporation**;
- (i) the following STEM summary information:
- i. for each Trading Interval in each completed Trading Day in the previous 12 calendar months:
 - 1. the total STEM Offer quantity;
 - 2. the total STEM Bid quantity;
 - 3. whether the STEM was suspended in relation to the relevant Trading Interval;
 - 4. where the STEM was not suspended, the STEM quantity purchased by the IMO; and

Which equals the quantity sold.

- 5. where the STEM was not suspended, the STEM Clearing Price;
- ii. for each Trading Interval in each completed Trading Week during the 12 calendar months ending on the last day of the calendar month two months prior to the current calendar month:
 - 1. the STEM Offers by Market Participant;
 - 2. the STEM Bids by Market Participant;

3. the quantity bought or sold in the STEM by Market Participant; and
 4. the Fuel Declaration, Availability Declaration and, if applicable, Ancillary Service Declaration made by the Market Participant;
- (j) for each Trading Interval in each completed Trading Day in the previous 12 calendar months the following dispatch summary information:
- i. the values of MCAP, UDAP and DDAP;
 - ii. the Load Forecasts prepared by System Management in accordance with clause 7.2.1;
 - iii. the sum of the Metered Schedule load for all Non-Dispatchable Load, Dispatchable Load, Interruptible Load and Curtailable Load;
 - iv. estimates of the energy not served due to involuntary load curtailment; and
 - v. any shortfalls in Ancillary Services;
- (k) any Market Advisories and Dispatch Advisories released in the previous 12 months;
- (l) Loss Factors for each network connection point in accordance with clause 2.27;
- (m) the most current Statement of Opportunities Report;
- (n) the medium term PASA report described in clause 3.16.9;
- (o) the short-term term PASA report described in clause 3.17.2;

These are required to be published under Chapter 3 so have been added here. The short-term PASA report has been removed from the list of SWIS Restricted Information. Public comments were received indicating that this information should be public.

- (p) details of resolved Disputes, including all Public Information associated with the dispute, but not aspects of the resolution or information associated with the resolution which, in accordance with its confidentiality status class, cannot be made public
- (q) public consultation proceedings;
- (r) Public Reports pertaining to the Wholesale Electricity Market issued by:
- i. the IMO;
 - ii. System Management;
 - iii. the Energy Review Board;
 - iv. the Economic Regulation Authority; or
 - v. the Minister.

Chapter 10

- (s) event reports explaining what happened during unusual market or dispatch events but not aspects of such reports which, in accordance with its confidentiality status class, cannot be made public;
- (t) the IMO and System Management budget information for the current financial year;
- (u) a schedule of fees for services provided by the IMO;

Fees might be prescribed for processing registration, doing special runs of settlement in response to a dispute, or in response to special requests for information.

- (v) summary information pertaining to the account maintained by the IMO for market settlement for the preceding 24 calendar months, including:
 - i. the end of month balance;
 - ii. the total income received for transactions in each of the Reserve Capacity Mechanism, the STEM, Balancing, Market Fees, System Operation Fees, Regulator Fees and a single value for all other income;
 - iii. the total outgoings paid for transactions in each of the Reserve Capacity Mechanism (excluding Supplementary Capacity Contracts), Supplementary Capacity Contracts, the STEM, Balancing and a single value for all other expenses; and
 - iv. Service Fee Settlement Amount paid to the IMO, System Management and the Economic Regulation Authority;

It has been suggested that clauses (ii) and (iii) should be removed as they could reveal too much information about the Electricity Generation Corporation's trades in the market. However, since the market trades only relate to deviations from bilateral contract positions (which could be positive or negative) this seems unlikely.

Further, the clauses have been changed to refer to particular market components as the clause previously referred to "Market Participant classes" which is a concept that no longer exists.

(vA) the non-compliance cost described in clause 9.10A.2;

(vB) reports providing the MWh of non-compliance of the Electricity Generation Corporation by Trading Interval, as specified by System Management in accordance with clause 7.13.1(cC), for each Trading Month which has been settled;

(vC) reports providing the MWh quantities of energy dispatched under Balancing Support Contracts by Facility and Trading Interval, as specified by System Management in accordance with clause 7.13.1(dA), for each Trading Month which has been settled;

- (w) the STEM Price for each Trading Interval of the current Trading Month for which STEM auction results have been released to Market Participants; and
- (x) for each Trading Interval of the current Trading Month for which balancing price results have been released to Market Participants;
 - i. the values of MCAP, UDAP and DDAP; and
 - ii. the load forecast prepared by System Management in accordance with clause 7.2.1(b).
- (y) as soon as possible after a Trading Interval:
 - i. the total generation in that Trading Interval;
 - ii. the total spinning reserve in that Trading Interval;
 - iii. an initial value of the Operational System Load Estimate, taken directly from System Management's EMS/SCADA system.

This is called an "initial value" since the final value provided by System Management after the Trading Day may need to be refined to clean up any data errors.

where these values are to be available from the IMO Web Site for each Trading Interval in the previous 12 calendar months; and

- (z) as soon as possible after real-time:
 - i. the total generation;
 - ii. the total spinning reserve;
 - iii. an initial value of the Operational System Load Estimate, taken directly from System Management's EMS/SCADA system;

where these values are not required to be maintained on the IMO Web Site after their initial publication.

10.6. SWIS Restricted Information

10.6.1. The IMO must set the class of confidentiality status for the following information under clause 10.2.1, as SWIS Restricted Information and the IMO must make this information available from the Market Web Site:

- (a) summary information on Disputes in progress that may impact other Rule Participants;

For instance, if a Market Participant disputes the conduct of the settlement process, then other Market Participants should be informed of this so that they can assess whether or not the alleged problem has affected them.

- (b) schedules of Planned Outages;
- (c) the current Dispatch Merit Order;

Chapter 10

- (d) audit reports; and
- (e) documentation of the functionality of :
 - i. any software used to run the Reserve Capacity Auction;
 - ii. the STEM Auction software; and
 - iii. the Settlement System software.

This information may be commercially sensitive but should be available to Rule Participants.

10.7. Rule Participant Market Restricted Information

10.7.1. The IMO must set the class of confidentiality status for the following information under clause 10.2.1, as Rule Participant Restricted Information and the IMO must make this information available from the Market Web Site:

- (a) all Reserve Capacity Offer information issued by that Market Participant and all details of Special Price Arrangements for that Market Participant prior to the publication of that information in accordance with clause 10.5.1(f);
- (b) Market Participant specific Reserve Capacity Obligations;
- (c) Market Customer specified Individual Capacity Reserve Requirements partitioned into those associated with Intermittent Loads and those not associated with Intermittent Loads;
- (d) for each completed Trading Day for the past 12 months:
 - i. Market Participant specific Bilateral Submissions, Resource Plan Submissions, Balancing Data Submissions and Standing Balancing Data submissions used in the absence of a Balancing Data Submission;
 - ii. Market Participant specific STEM Submissions and Standing STEM Submissions used in the absence of a STEM Submission except that information published in accordance with clause 10.5.1(i);
- (e) for the past 12 months:
 - i. Non-STEM Settlement Statements; and
 - ii. STEM Settlement Statements

10.8. Rule Participant Dispatch Restricted Information

10.8.1. The IMO must set the class of confidentiality status for a Market Participant Specific Dispatch Schedules under clause 10.2.1, as Rule Participant Dispatch Restricted Information and the IMO must make this information available from the Market Website for each Trading Interval in completed Trading Months for the past 12 Trading Months.

Chapter 10

Standing Data does not need to be on the website as there is a paper trail relating to it from the submission process.

10.8.2. The IMO must set the class of confidentiality status for all Electricity Generation Corporation information specified in clauses 7.6A as Rule Participant Dispatch Restricted Information with the exception of information specified by the Electricity Generation Corporation under clauses 7.6A.2(g) and 7.6A.3(c).

Clauses 7.6A.2(g) and 7.6A.3(c) relate to declarations by the Electricity Generation Corporation that it cannot comply with its schedules. This information should not be required by the rules to be confidential, though the rules leave the IMO the ability to set the confidentiality status.

11 Glossary

Acceptable Credit Criteria: The criteria set out in clause 2.38.6.

Access Code: The code established by the Minister under section 104 of the Electricity Industry Act 2004.

Access Offer: Has the meaning given in clause 4.2.7(b)(ii)(1).

Adjustment Process: Has the meaning given in clause 9.16.3.

Administration Procedure: The Market Procedure developed by the IMO in accordance with clause 2.9.5.

Allowable Revenue: With respect to the IMO, the allowable revenue for the IMO in providing the services set out in clause 2.22.1 as approved by the Economic Regulation Authority in accordance with clause 2.22.2. With respect to System Management, the allowable revenue for System Management in providing the services set out in clause 2.23.1 as approved by the Economic Regulation Authority in accordance with clause 2.23.12.

Alternative Maximum STEM Price: The maximum price set in accordance with clause 6.20.3 that may be associated with a Portfolio Supply Curve for a portfolio including Facilities expected to run on Liquid Fuel or any Portfolio Demand Curve forming part of a STEM Submission or Standing STEM Submission.

Amending Rules: Has the meaning given in clause 2.4.1(c).

Ancillary Service: A service, including those described in clause 3.9, that is required to maintain Power System Security and Power System Reliability, facilitate orderly trading in electricity and ensure that electricity supplies are of acceptable quality.

Ancillary Service Contract: A contract between System Management and a Market Participant for the provision by that Market Participant of an Ancillary Service or Ancillary Services to System Management.

Ancillary Service Declaration: A declaration included with a STEM Submission or Standing STEM Submission made by a Market Participant which is a provider of Ancillary Services and which includes the information described in clause 6.6.2A(c).

Ancillary Service Provider: A Rule Participant registered as an Ancillary Service Provider under clauses 2.28.11A.

Ancillary Service Requirements: Are as determined in accordance with clause 3.11.

Application Fee: A fee determined by the IMO under clause 2.24.2.

Chapter 11

Appointed Day: Means the day fixed by the Minister by order published in the Government Gazette.

Arrangement for Access: When used in the context of a “covered network” (as that term is defined in the Access Code) means an “access contract” (as that term is defined in the Access Code). When used in the context of a network which is not a “covered network” (as that term is defined in the Access Code) means any commercial arrangement through which “access” (as that term is defined in the Access Code) to that network is obtained.

Authorised Deviation Quantity (ADQ(p,d,t)): For a Market Participant p for a given Trading Interval t, is as calculated under clause 6.17.2

Availability Class: Any one of 4 classes of annual availability of Reserve Capacity set out in clause 4.5.12(c), where each class corresponds to Reserve Capacity being available from a Facility for not more than a specified number of hours per year.

Availability Curve: A curve developed by the IMO under clause 4.5.10(e).

Availability Declaration: A declaration included with a STEM Submission or Standing STEM Submission and which includes the information described in clause 6.6.2A(b).

Balancing: The process for meeting supply and consumption deviations from contracted bilateral and STEM positions in each Trading Interval.

Balancing Data: A set of prices to be used in forming Dispatch Merit Orders and in settling Balancing transactions for a Trading Day as provided by a Market Participant to the IMO in a Balancing Data Submission or as Standing Balancing Data.

Balancing Data Submission: A submission of Balancing Data to the IMO made in accordance with clause 6.5A.

Balancing Support Contract: A contract between either the Electricity Generation Corporation or System Management and a Market Participant (other than the Electricity Generation Corporation), entered into pursuant to clause 7.6.7, that allows System Management to call upon the Facilities registered by the relevant Market Participant to assist System Management and the Electricity Generation Corporation in meeting their obligations under Chapter 7.

Bank Bill Rate: The rate set by the IMO:

- (a) at approximately 10:00am on any given Business Day to apply for that day; or
- (b) if the relevant day is not a Business Day, or the IMO does not set a rate for that day, on the previous Business Day on which a rate was set under paragraph (a),

(based on an industry standard market indicator, details of which must be published by the IMO).

Chapter 11

Bilateral Contract: A contract formed between any two persons (excluding System Management) for the sale of electricity by one of those persons to the other.

Bilateral Submission: A submission by a Market Generator to the IMO made in accordance with clause 6.2.

Business Day: A day that is not a Saturday, Sunday, or a public holiday throughout Western Australia.

Capacity Cost Refund: Has the meaning given in clause 4.26.3.

Capacity Credit: A notional unit of Reserve Capacity provided by a Facility during a Capacity Year. The total number of Capacity Credits provided by a Facility is determined in accordance with clause 4.20 or clause 4.28B. Each Capacity Credit is equivalent to 1MW of Reserve Capacity. The Capacity Credits to be provided by a Facility are held by the Market Participant registered in respect of that Facility. The number of Capacity Credits to be provided by a Facility may be reduced in certain circumstances under the Market Rules, including under clause 4.25.4 or adjusted under clause 4.25.6.

Capacity Credit Allocation: The number of Capacity Credits allocated to a Market Participant for settlement purposes through the allocation process in clauses 9.4 and 9.5.

Capacity Credit Allocation Submission: A submission from a Market Participant to the IMO in accordance with clause 9.4.1.

Capacity Shortfall: Has the meaning given in clause 4.26.2.

Capacity Year: A period of 12 months commencing at the start of the Trading Day which commences on 1 October and ending on the end of the Trading Day ending on 1 October of the following calendar year.

Category A: The class of Market Rules classified as Category A Market Rules in the Regulations for the purposes of the imposition of civil penalties under the Regulations.

Category B: The class of Market Rules classified as Category B Market Rules in the Regulations for the purposes of the imposition of civil penalties under the Regulations.

Category C: The class of Market Rules classified as Category C Market Rules in the Regulations for the purposes of the imposition of civil penalties under the Regulations.

Certified Reserve Capacity: For a Facility, and in respect of a Reserved Capacity Cycle, is the quantity of Reserve Capacity that the IMO has assigned to the Facility for the Reserve Capacity Cycle in accordance with clause 4.11 or clause 4.28B, as adjusted under these Market Rules including clause 4.14.8. Certified Reserve Capacity assigned to a Facility registered by a Market Participant is held by that Facility.

Chapter 11

Chief Executive Officer: In respect of a Rule Participant other than System Management, the chief executive officer of the relevant Rule Participant, or if that Rule Participant has no chief executive officer, then the individual nominated by the Rule Participant and holding a similar position to that of chief executive officer of the Rule Participant. With respect to System Management, the most senior of the persons designated by the Board of **the Electricity Network Corporation** as having responsibility for the management of System Management.

Cold Season: The period commencing at the start of the Trading Day beginning on 1 April and ending at the end of the Trading Day finishing on the following 1 October.

Commissioning Test: Has the meaning given in clause 3.21A.1.

Commitment Compensation: The amount calculated in accordance with clauses 6.18.2.

Conditional Certified Reserve Capacity: Has the meaning given in clause 4.9.5.

Consequential Outage: Has the meaning given in clause 3.21.2.

Consumption Decrease Price: A price specified in Balancing Data to apply in forming the Dispatch Merit Order for a Trading Interval for a Dispatchable Load and in the calculation of the Dispatch Instruction Payment for that Dispatchable Load for that Trading Interval. Different values apply for Peak Trading Intervals and Off-Peak Trading Intervals.

Consumption Increase Price: A price specified in Balancing Data to apply in forming the Dispatch Merit Order for a Trading Interval for a Dispatchable Load and in the calculation of the Dispatch Instruction Payment for that Dispatchable Load for that Trading Interval. Different values apply for Peak Trading Intervals and Off-Peak Trading Intervals.

Contestable Customer: A person that may purchase electrical energy from any retailer, including **the Electricity Retail Corporation**.

Corporations Act: The Corporations Act 2001 (Cwlth).

Credit Limit: In respect of a Market Participant, the amount determined by the IMO in accordance with clause 2.37.4. In respect of a Network Operator, the amount determined by the IMO in accordance with clause 2.37.6.

Credit Support: Has the meaning given in clause 2.38.4.

Cure Notice: Has the meaning given in clause 9.23.4(a).

Customer: Means a person to whom electricity is sold for the purpose of consumption.

Curtailed Load: A Load through which electricity is consumed where such consumption can be curtailed at short notice by the party managing the Load or in response to a request

Chapter 11

from System Management to the party managing the Load, and registered as such in accordance with clause 2.29.5(b).

Declared Market Project: A major market development project declared by the IMO in accordance with clauses 2.22.13 and approved by the Economic Regulation Authority in accordance with clause 2.22.14.

Default Levy: The amount, in respect of a given Market Participant and in the circumstance of a particular Payment Default, determined by the IMO in accordance with clause 9.24.5.

Demand Side Management: A type of capacity held in respect of a Facility connected to the SWIS; specifically, the capability of a Facility connected to the SWIS to reduce its consumption of electricity through the SWIS, as measured at the connection point of the Facility to the SWIS.

Demand Side Programme: Means a programme under which a Market Customer contracts Loads to be available for curtailment upon request of the Market Customer or System Management.

Derogation: An exemption or modification to the Market Rules applicable to one or more Rule Participants set out in Chapter 11 of these Market Rules.

Dispatch Advisory: Has the meaning given in clause 7.11.1.

Dispatch Instruction: Has the meaning given in clause 7.7.1.

Dispatch Merit Order: An ordered list of Scheduled Generators and Dispatchable Loads registered by Market Participants, other than **the Electricity Generation Corporation**, determined by the IMO in accordance with clause 6.12.1, indicating the order in which those Scheduled Generators and Dispatchable Loads should receive Dispatch Instructions from System Management in the circumstances to which the relevant Dispatch Order applies.

Dispatch Plan: Means the schedule of energy and Ancillary Services to be provided, or to be available to be provided on request, by the Registered Facilities of the Electricity Generation Corporation during a Trading Day, where this schedule may be revised by System Management during the course of the corresponding Scheduling Day and the Trading Day.

Dispatch Schedule: Has the meaning given in clause 6.15.1 or 6.15.2, as applicable.

Dispatch Support: Has the meaning given in clause 3.9.9.

Dispatchable Load: A Load, with a rated capacity of not less than 0.2 MW, through which electricity is consumed where such consumption can be increased or decreased to a specified level upon instruction to do so by System Management to the person managing the Load, and registered as such in accordance with clause 2.29.5(c).

Chapter 11

Dispute Participants: The parties to a relevant dispute described in clause 2.18.2.

Downward Deviation Administrative Price (DDAP): The amount calculated under clause 6.14.6.

Downward Unauthorised Deviation Quantity (DUDQ (p, d, t)): The amount calculated in accordance with clause 6.17.4.

Draft Rule Change Report: The draft report published under clause 2.7.6(a) by the IMO in relation to a Rule Change Proposal.

draw upon: In relation to Credit Support or Reserve Capacity Security held by the IMO in relation to a Market Participant, means that the IMO:

- (a) in relation to a Security Deposit, applies the Security Deposit to satisfy amounts owing by the relevant Market Participant; or
- (b) in relation to other Credit Support, exercises its rights under the Credit Support, including by drawing or claiming an amount under it.

Economic Regulation Authority: The body established under section 4(1) of the Economic Regulation Authority Act, responsible under these Market Rules for market monitoring and surveillance.

Electricity Corporations Act: Electricity Corporations Act 2005 (WA).

Electricity Generation Corporation: Means the body established by section 4(1)(a) of the Electricity Corporations Act.

Electricity Networks Corporation: Means the body established by section 4(1)(b) of the Electricity Corporations Act.

Electricity Retail Corporation: Means the body established by section 4(1)(c) of the Electricity Corporations Act. **Eligible Services:** Has the meaning given in clause 4.24.3.

Emergency Operating State: The state of the SWIS defined in clause 3.5.1.

Energy Market Commencement: The date and time at which the first Trading Day commences, as published by the Minister in the Government Gazette.

Energy Price Limits: The set of price limits comprising the Maximum STEM Price, the Alternative Maximum STEM Price, the Minimum STEM Price and the Maximum Shutdown Price.

Energy Review Board: The Board within the meaning of the Electricity Industry Act.

Environmental Approval: In respect of a Facility is a licence, consent, certificate, notification, declaration or other authorisation required under any law relating to the

Chapter 11

protection or conservation of the environment for the lawful construction of the Facility or the development of the site on which the Facility is to be constructed.

Equipment Limit: Any limit on the operation of a Facility's equipment that is provided as Standing Data for the Facility to System Management by the IMO in accordance with clause 2.34.1(b).

Facility: Any of the facilities described in clause 2.29.1.

Facility Classes: Network, Scheduled Generator, Non-Scheduled Generator, Interruptible Load, Curtailable Load and Dispatchable Load.

Facility Dispatch Tolerance: The quantity by which the Metered Schedule of a Scheduled Generator registered by a Market Participant other than **the Electricity Generation Corporation** can deviate from the Dispatch Schedule for that Scheduled Generator before the Upward Deviation Administrative Price (UDAP) or the Downward Deviation Administrative Price (DDAP) will be applied to that deviation in settlement as determined under clause 6.17.9.

Fast Track Rule Change Process: The process for dealing with Rule Change Proposals set out in clause 2.6.

Final Rule Change Report: In respect of a Rule Change Proposal to which the Fast Track Rule Change Process applies, the report published by the IMO in accordance with clause 2.6.4. In respect of a Rule Change Proposal to which the Standard Rule Change Process applies, the report published by the IMO in accordance with clause 2.7.8.

Financial Year: A period of 12 months commencing on 1 July.

Forced Outage: Has the meaning given in clause 3.21.1.

Fuel Declaration: A declaration included with a STEM Submission or Standing STEM Submission and which includes the information described in clause 6.6.2A(a).

High Risk Operating State: The state of the SWIS described in clause 3.4.

Hot Season: The period commencing at the start of the Trading Day beginning on 1 December and ending at the end of the Trading Day finishing on the following 1 April.

IMO: The Independent Market Operator, established under the Regulations to administer and operate the Wholesale Electricity Market.

IMO Confidential: An information confidentiality status whereby information or documents may only be made available to the parties described in clause 10.2.2(f).

Chapter 11

IMO Deposit Rate: A rate equal to the rate received by the IMO for the Security Deposit. (The IMO must use reasonable endeavours to obtain a rate which reflects reasonable commercial terms as regards to other deposit rates available at the time.)

Individual Reserve Capacity Requirement: The MW quantity determined by the IMO in respect of a Market Customer, in accordance with clause 4.28.7 and, if applicable, as revised in accordance with clause 4.28.11.

Initial Time: Has the meaning given in clause 4.1.25.

Intermediate Season: The interval commencing at the start of the Trading Day beginning on 1 October and ending at the end of the Trading Day finishing on the following 1 December of the same year.

Intermittent Generator: A Non-Scheduled Generator that cannot be scheduled because its output level is dependent on factors beyond the control of its operator (e.g. wind).

Intermittent Load: A type of Load defined under clause 2.30B.1.

Intermittent Load Refund: Has the meaning given in clause 4.28A.1.

Interruptible Load: A Load through which electricity is consumed, where such consumption can be curtailed automatically in response to a change in system frequency, and registered as such in accordance with clause 2.29.5(a).

Interval Meter Deadline: The date determined in accordance with clause 9.16.2(a).

Invoice: An invoice requesting payment for transactions under these Market Rules issued under Chapter 9. An Invoice may relate to STEM Settlement Statements, Non-STEM Settlement Statements or adjusted Settlement Statements.

Invoicing Date: The Business Day, determined in accordance with clauses 9.16.1(a), 9.16.2(d) or 9.16.4(c), on which the IMO must release Invoices for STEM Settlement Statements for a Trading Week, Non-STEM Settlement Statements for a Trading Month and the Adjustment Process respectively.

Liquid Fuel: Means distillate, fuel oil or liquefied petroleum gas.

Liquid Supply Decrease Price: A price specified in Balancing Data to apply in forming the Dispatch Merit Order for a Trading Interval for a Scheduled Generator declared to be operating on Liquid Fuel and in the calculation of the Dispatch Instruction Payment for that Scheduled Generator when declared to be operating on Liquid Fuel during that Trading Interval. Different values apply for Peak Trading Intervals and Off-Peak Trading Intervals.

Liquid Supply Increase Price: A price specified in Balancing Data to apply in forming the Dispatch Merit Order for a Trading Interval for a Scheduled Generator declared to be operating on Liquid Fuel and in the calculation of the Dispatch Instruction Payment for that

Chapter 11

Scheduled Generator when declared to be operating on Liquid Fuel during that Trading Interval. Different values apply for Peak Trading Intervals and Off-Peak Trading Intervals.

Load: Has the meaning given in clause 2.29.1(d).

Load Following Service: Has the meaning given in clause 3.9.1.

Load Forecast: An expectation of the demand levels in the SWIS or in a region of the SWIS in future Trading Intervals.

Load Rejection Reserve Service: Has the meaning given in clause 3.9.6.

Long Term PASA: A PASA study conducted in accordance with clause 4.5 in order to determine the Reserve Capacity Target for each year in the Long Term PASA Study Horizon and prepare the Statement of Opportunities Report for a Reserve Capacity Cycle.

Long Term PASA Study Horizon: The ten year period commencing on 1 October of Year 2 of a Reserve Capacity Cycle.

Long Term Special Price Arrangement: A Special Price Arrangement that applies for more than one Reserve Capacity Cycle.

Loss Factor: A factor defining the annual average marginal network loss between any given node and the Reference Node where the Loss Factor at the Reference Node is 1, determined in accordance with clause 2.27.2.

Loss Factor adjusted: In respect of a quantity of electricity, means that quantity multiplied by any applicable Loss Factor.

Margin Call: The amount determined in accordance with clause 2.42.3.

Margin Call Notice: A notification by the IMO to a Market Participant that the Market Participant's Trading Margin has dropped below zero, and requiring the payment of a Margin Call.

Marginal Cost Administrative Price (MCAP): The dollar per MWh price calculated in accordance with clause 6.14.2.

Market Advisory: Has the meaning given in clause 6.19.1.

Market Advisory Committee: An advisory body to the IMO comprised of industry representatives established under clause 2.3.1.

Market Auditor: An auditor appointed by the IMO under clause 2.14.1.

Market Customer: A Rule Participant registered as a Market Customer under clauses 2.28.10, 2.28.11 or 2.28.13.

Chapter 11

Market Fees: The fees determined by the IMO in accordance with clauses 2.24, and calculated for each Market Participant in accordance with clause 9.13.1.

Market Generator: A Rule Participant registered as a Market Generator under clauses 2.28.6, 2.28.7, 2.28.8 or 2.28.13.

Market Participant: A Rule Participant that is a Market Generator or a Market Customer.

Market Procedure: The procedures developed by IMO and System Management in accordance with clause 2.9, as amended in accordance with the Procedure Change Process.

Market Rules: These rules relating to the Wholesale Electricity Market and to the operation of the SWIS.

Market Surveillance Data Catalogue: The catalogue developed by the IMO under clause 2.16.2.

Market Web Site: Has the meaning given in the Regulations.

Maximum Consumption Capability: For each Market Participant is as calculated in accordance with clause 6.3A.2(b).

Maximum Reserve Capacity Price: In respect of a given Reserve Capacity Cycle, the price in clause 4.16.2 as revised in accordance with clause 4.16.

Maximum Shutdown Price: The maximum per MW price, determined under clause 6.20.5, that can be used in setting the level of compensation a Market Participant other than the Electricity Generation Corporation requires in response to being requested by System Management to shutdown a Scheduled Generator.

Maximum STEM Price: The price determined in accordance with clause 6.20.2 as the maximum price that may be associated with a Portfolio Supply Curve for a portfolio including no Facilities expected to run on Liquid Fuel forming part of a STEM Submission or Standing STEM Submission.

Maximum Supply Capability: For each Market Participant is as calculated in accordance with clause 6.3A.2(a).

Medium Term PASA: A PASA study conducted in accordance with clause 3.16 in order to assist System Management in determining Ancillary Service Requirements, outage planning for Registered Facilities and also assessing the availability of Facilities in respect of which Capacity Credits are held.

Meter Data Submission: A submission of meter data by a Metering Data Agent to the IMO in accordance with clause 8.4.

Chapter 11

meter dispute: Has the meaning given in clause 8.6.1(e).

Meter Registry: A registry maintained by a Metering Data Agent containing information about meters and the persons with which those meters are associated including the information listed in clause 8.3.1.

Metered Schedule: Has the meaning given in clause 6.16.1.

Metering Data Agent: The person identified under clause 8.1.2 or clause 8.1.4.

Metering Protocol: A combination of the Metering Data Rules as specified by the Economic Regulation Authority and a Network Operator's metering requirements as a condition of access. The metering requirement means in the context of a "covered network" (as that term is defined in the Access Code) the "Metering Rules" as defined in the Access Code while when used in the context of a network which is not a "covered network" (as that term is defined in the Access Code) means any commercial arrangement for metering energy.

The definition of the Metering Protocol is subject to finalisation of the Metering Rules arrangements.

Minimum Frequency Keeping Capacity: Has the meaning given in clause 3.10.1(a).

Minimum STEM Price: The price determined in accordance with clause 6.20.4 as the minimum price that may be associated with a Portfolio Supply Curve or a Portfolio Demand Curve forming part of a STEM Submission or Standing STEM Submission.

Minister: The Minister responsible for administering the Electricity Industry Act.

Monitoring and Reporting Protocol: The procedure developed by System Management and approved by the IMO in accordance with clauses 2.15.4 and 2.15.7 and, if applicable, as amended in accordance with clauses 2.9 and 2.10.

Monitoring Protocol: The procedure developed by the IMO in accordance with clause 2.15.1, 2.15.7 and, as amended from time to time in accordance with clauses 2.9 and 2.10.

Monthly Availability Payment: The maximum monthly payment by a Network Operator to a Market Participant providing capacity under a Network Control Service Contract.

Monthly Reserve Capacity Price: The dollar per megawatt per Trading month price calculated in accordance with clause 4.29.1.

Monthly Special Reserve Capacity Price: The dollar per megawatt per Trading Month price calculated in accordance with clause 4.29.2.

MW: Means megawatt.

MWh: Means megawatt-hour.

Chapter 11

Net Contract Position: In respect of a Market Participant for a Trading Interval is calculated in accordance with clause 6.9.13.

Network: A transmission system or distribution System registered as a Network under clause 2.29.3.

Network Control Service: Has the meaning given in clause 5.1.1.

Network Control Service Certification: Has the meaning given in clause 5.3.2.

Network Control Service Contract: A contract between the IMO and a Market Participant, entered into pursuant to chapter 5, to provide a Network Control Service.

Network Operator: A person who registers as a Network Operator, in accordance with clause 2.28.2, 2.28.3 or 2.28.4.

Non-Dispatchable Load: A Load which is not a Dispatchable Load, a Curtailable Load or an Interruptible Load, and is therefore self scheduled.

Non-Liquid Fuel: Means all fuels other than Liquid Fuel.

Non-Liquid Supply Decrease Price: A price specified in Balancing Data to apply in forming the Dispatch Merit Order for a Trading Interval for a Scheduled Generator declared to be operating on Non-Liquid Fuel and in the calculation of the Dispatch Instruction Payment for that Scheduled Generator when declared to be operating on Non-Liquid Fuel during that Trading Interval. Different values apply for Peak Trading Intervals and Off-Peak Trading Intervals.

Non-Liquid Supply Increase Price: A price specified in Balancing Data to apply in forming the Dispatch Merit Order for a Trading Interval for a Scheduled Generator declared to be operating on Non-Liquid Fuel and in the calculation of the Dispatch Instruction Payment for that Scheduled Generator when declared to be operating on Non-Liquid Fuel during that Trading Interval. Different values apply for Peak Trading Intervals and Off-Peak Trading Intervals.

Non-Scheduled Generator: A generation system that can be self-scheduled by its operator (with the exception that System Management can require it to decrease its output subject to its physical capabilities) and which is registered as a Non-Scheduled Generator in accordance with clause 2.29.4(a) or (d).

Non-STEM Settlement Date: The Business Day, determined under clause 9.16.2(e), on which the IMO issues Non-STEM Settlement Statements relating to a Trading Month.

Non-STEM Settlement Statement: A settlement statement for a Trading Month containing the information described in clause 9.18.3.

Non-STEM Settlement Statement Date: Has the meaning given in clause 9.16.2(c).

Chapter 11

Non-STEM Settlement Disagreement Deadline: Has the meaning given in clause 9.16.2(f).

Non-Temperature Dependent Load: A Load accepted by the IMO as a Non-Temperature Dependent Load under clause 4.28.9.

Normal Operating State: The state of the SWIS defined in clause 3.3.1.

Notice of Disagreement: A notice issued by a Market Participant under any of clause 9.17.3, clause 9.18.4 or clause 9.19.5, to the IMO indicating a disagreement with either a STEM Settlement Statement or a Non-STEM Settlement Statement.

Notice of Dispute: A notice issued under clause 2.19.1 and containing the information described in clause 2.19.3.

Notional Wholesale Meter: A notional interval meter quantity associated with a Market Customer's aggregate consumption **not metered by Trading Interval**. This value will be an estimate produced by the IMO.

Off-Peak Trading Interval: A Trading Interval occurring between 10 PM and 8 AM.

Operational System Load Estimate: Has the meaning given in clause 6.14.4(a).

Opportunistic Maintenance: Has the meaning given in clause 3.19.2.

Outage Contingency Plan: Part of an Outage Plan specifying contingency plans for returning the relevant item of equipment to service before the time when the outage or de-rating is planned to finish.

Outage Plan: Has the meaning given in clause 3.18.4A and includes a revised Outage Plan submitted under clause 3.18.9.

Outstanding Amount: The amount calculated in accordance with clause 2.40.1.

PASA: See Projected Assessment of System Adequacy.

parasitic load: Energy consumption that occurs behind the connection point at which a generation system is connected to the Network, and which consequently reduces the energy sent-out by the generation system relative to the energy actually generated by the generation system.

Payment Default: Any failure to make a payment in respect of an Invoice in accordance with clause 9.22 or 9.24.7 or pay any other amount owing under these Market Rules by the time it is due.

Peak Trading Interval: A Trading Interval occurring between 8 AM and 10 PM.

Planned Outage: Has the meaning given in clause 3.19.11.

Chapter 11

Planning Criteria: Has the meaning given in clause 4.5.9.

Portfolio Demand Curve: A curve describing the STEM Price at which a Market Participant will purchase different levels of energy from the market having the form given in clause 6.6.2A(e).

Portfolio Supply Curve: A curve describing the STEM Price at which a Market Participant will provide the market with different levels of energy supply having the form given in clause 6.6.2A(d).

Power System Adequacy: The ability of the SWIS to supply all demand for electricity in the SWIS at the time, allowing for scheduled and unscheduled outages of generation, transmission and distribution equipment and secondary equipment.

Power System Operation Procedure: The Market Procedure developed by System Management pursuant to clause 3.2.7.

Power System Reliability: The ability of the SWIS to deliver energy within reliability standards while maintaining Power System Adequacy and Power System Security.

Power System Security: The ability of the SWIS to withstand sudden disturbances, including the failure of generation, transmission and distribution equipment and secondary equipment.

Price-Quantity Pair: In the context of Reserve Capacity Offers, Supply Portfolio Curves and STEM Offers, a quantity that will be provided to the IMO by a Market Participant for a price equalling or exceeding the specified price. In the context of Demand Portfolio Curves and STEM Bids, a quantity that will be purchased from the IMO by a Market Participant for a price equalling or less than the specified price.

Procedure Amendment: The specific wording of a proposed or accepted change to a Market Procedure.

Procedure Change Process: The process for amending a Market Procedure as set out in clauses 2.10 and 2.11.

Procedure Change Proposal: A proposal developed by the IMO or System Management to initiate a Procedure Change Process.

Procedure Change Report: A final report published by the IMO or System Management in relation to a Procedure Change Proposal, containing the information described in clause 2.10.13.

Procedure Change Submission: A submission made in relation to a Procedure Change Proposal submitted in accordance with clause 2.10.7.

Chapter 11

Projected Assessment of System Adequacy (PASA): A forecasting study, undertaken by the IMO in the case of a Long Term PASA, and undertaken by System Management in the case of a Short Term PASA and a Medium Term PASA.

Protected Provision: A chapter or clause of the Market Rules, identified in clause 2.8.13.

Prudential Obligations: In respect of a Market Participant or Network Operator, the obligations set out in clauses 2.37 to 2.43.

Public: When used in reference to information confidentiality, an information confidentiality status whereby information or documents may be made available to any person.

Ready Reserve Standard: Has the meaning given in clause 3.18.11A.

Reference Node: The Muja 330 bus-bar (relative to which Loss Factors are defined).

Refund Table: The table titled “Refund Table” and set out in Chapter 4.

Registered Facility: In respect of a Rule Participant, a Facility registered by that Rule Participant with the IMO under Chapter 2.

Regulations: Any regulations made under the Electricity Industry Act 2004 (WA) but excluding the Electricity Industry (Wholesale Market) Regulations 2004 (WA).

Regulator Fees: The fees determined by the IMO in accordance with clause 2.24, and payable by Market Participants for the services provided by the Economic Regulation Authority in undertaking its Wholesale Electricity Market related functions and other functions under these Market Rules.

Relevant Settlement Statements: Has the meaning given in clause 9.16.3.

Relevant Quantity: Has the meaning given in clause 6.14.4(d).

Repaid Amount: Has the meaning given in clause 9.24.2(a).

Representative: In relation to a person means a representative of that person, including an employee, agent, officer, director, auditor, adviser, partner, consultant, joint venturer or sub-contractor, of that person.

Request for Expression of Interest: In respect of a Reserve Capacity Cycle, the request for expression of interest made available in accordance with clause 4.2.2.

Reserve Capacity: Capacity associated with a Facility. Capacity may be:

- (a) the capacity of generation Systems to generate electricity and send it out into a network forming part of the SWIS; or

Chapter 11

- (b) Demand Side Management, being the capability of a Facility registered by the Market Customer at a connection point to a Network forming part of the SWIS to reduce the consumption of electricity at that connection point.

Reserve Capacity Auction: The process for determining the Reserve Capacity Price for a Reserve Capacity Cycle and the quantity of Reserve Capacity scheduled by the IMO for each Market Participant under clause 4.19.

Reserve Capacity Auction Requirement: The quantity of Reserve Capacity calculated in accordance with clause 4.15.2(b), which is the target quantity to be procured in a Reserve Capacity Auction.

Reserve Capacity Cycle: The cycle of events described in clause 4.1.

Reserve Capacity Information Pack: A package of information, including the information described in clause 4.7.3, pertaining to a Reserve Capacity Auction.

Reserve Capacity Mechanism: Chapter 4 of the Market Rules.

Reserve Capacity Obligations: For a Market Participant holding Capacity Credits, determined in accordance with clause 4.12.1 or clause 4.28B.

Reserve Capacity Obligation Quantity: The specific amount of capacity required to be provided in a Trading Interval as part of a Reserve Capacity Obligation set by the IMO in accordance with clauses 4.12.4 and 4.12.5 or clause 4.28B as adjusted from time to time in accordance with these Market Rules, including under clause 4.12.6.

Reserve Capacity Offer: A submission from a Market Participant to the IMO, in the format and including the information described in clause 4.18.1.

Reserve Capacity Price: In respect of a Reserve Capacity Cycle, the price for Reserve Capacity determined in accordance with clause 4.29.1 and multiplied by 12, where this price is expressed in units of dollars per megawatt per year and has a value between zero and the Maximum Reserve Capacity Price.

Reserve Capacity Requirement: Has the meaning given in clause 4.6.1.

Reserve Capacity Security: Has the meaning given in clause 4.13.1.

Reserve Capacity Target: In respect of a Capacity Year, the IMO's estimate of the total amount of generation or Demand Side Management capacity required in the SWIS to satisfy the Planning Criteria for that Capacity Year determined in accordance with clause 4.5.10(b).

Resource Plan: A detailed schedule for all Trading Intervals in a relevant Trading Day, based on a Resource Plan Submission containing the information in clause 6.11 accepted by the IMO under clause 6.5.2(b) (as part of an accepted Resource Plan Submission) or set in accordance with clause 6.5.4 (in the case of a default Resource Plan).

Chapter 11

Resource Plan Deviation Quantity: The amount calculated in accordance with clause 6.17.5.

Resource Plan Load: Has the meaning given in clause 6.14.4(b).

Resources Plan Submission: A submission by a Market Participant to the IMO made in accordance with clause 6.5.

Review Period: In the case of the first Review Period, the 3 year period commencing on 1 July in the calendar year following the calendar year in which Energy Market Commencement occurs. For each subsequent Review Period, the 3 year period commencing on the third anniversary of the commencement of the previous Review Period.

Reviewable Decision: Decisions made by the IMO in respect of which an eligible person may apply to the Energy Review Board in accordance with section 125 of the Electricity Industry Act and the Regulations, and does not include any decisions of a class specified for this purpose in the Regulations under section 125 of that Act.

Rule Change Proposal: A proposal made in accordance with clause 2.5 proposing that the IMO make Amending Rules.

Rule Participant: Any person registered as a Rule Participant in accordance with Chapter 2, the IMO and System Management.

Rule Participant Dispatch Restricted: An information confidentiality status whereby information or documents may only be made available to the parties described in clause 10.2.2(d).

Rule Participant Market Restricted: An information confidentiality status whereby information or documents may only be made available to the parties described in clause 10.2.2(c).

Scheduled Generator: A generation system that can increase or decrease the quantity of electricity it generates and sends out into a network forming part of the SWIS (subject to limits on its physical capabilities) in response to instructions from System Management and is registered as such in accordance with clause 2.29.4(b) and (c).

Scheduled Outages: Has the meaning given in clause 3.19.1.

Scheduled System Load: Has the meaning given in clause 6.14.4(c).

Scheduling Day: In respect of a Trading Day, the calendar day immediately preceding the calendar day on which the Trading Day commences.

Season: As the context requires, any of the Cold Season, Intermediate Season or Hot Season.

Chapter 11

Security Deposit: Has the meaning given in clause 2.38.4(b).

Security Limit: Any technical limit on the operation of the SWIS as a whole, or a region of the SWIS, necessary to maintain the Power System Security, including both static and dynamic limits.

Service Fee Settlement Amount: Has the meaning given in clause 9.15.

Settlement Statement: A STEM Settlement Statement, a Non-STEM Settlement Statement, an adjusted STEM Settlement Statement or an adjusted Non-STEM Settlement Statement.

Shareholding Minister: The Minister responsible for administering the Electricity Corporation Act.

Short Term Energy Market (STEM): A forward market operated under Chapter 6 in which Market Participants can purchase electricity from, or sell electricity to, the IMO.

Short Term PASA: A PASA study conducted in accordance with clause 3.17.

Short Term Special Price Arrangement: A Special Price Arrangement that applies for not more than one Reserve Capacity Cycle.

South West Interconnected System (SWIS): Has the meaning given in the Electricity Industry Act.

Special Price Arrangement: An arrangement under clause 4.21 or 4.22 whereby a Market Participant can secure a price for Reserve Capacity that may differ from the Reserve Capacity Price.

Special Reserve Capacity Price: The dollar per megawatt per year price applicable to Capacity Credits held by a Market Participant in respect of a Registered Facility and subject to a Special Price Arrangement.

Spinning Reserve: Supply capacity held in reserve from synchronised Scheduled Generators, Dispatchable Loads or Interruptible Loads, so as to be available to support the system frequency in the event of an outage of a generating works or transmission equipment or to be dispatched to provide energy as allowed under these Market Rules.

Standard Rule Change Process: The process for dealing with Rule Change Proposals set out in clause 2.7.

Standing Balancing Data: Balancing Data stored by the IMO reflecting the information described in Appendix 1 provided to the IMO in accordance with clause 2.33.3(c)(x) or clause 2.34.

Standing Bilateral Submission: A submission by a Market Generator to the IMO made in accordance with clause 6.2A.

Chapter 11

Standing Data: Data maintained by the IMO under clause 2.34.1.

Standing Resource Plan: A submission related in Resource Plans by a Market Generator to the IMO made in accordance with clause 6.5C.

Standing STEM Submission: A submission by a Market Participant to the IMO made in accordance with clause 6.3C.

Statement of Corporate Intent: The statement of corporate intent as agreed by the Minister or otherwise deemed to apply by Division 2 of Part 5 of the Electricity Corporations Act.

Statement of Opportunities Report: A report prepared in accordance with clause 4.5.13 presenting the results of the Long Term PASA study, including a statement of required investment if Power System Security and Power System Reliability are to be maintained.

STEM: See Short Term Energy Market.

STEM Auction: The process, described in clause 6.9, used to clear the STEM.

STEM Bid: A bid to purchase energy from the IMO via the STEM Auction for a Trading Interval.

STEM Clearing Price: Has the meaning given in clause 6.9.7.

STEM Clearing Quantity: Has the meaning given in clause 6.9.8.

STEM Invoice: An Invoice issued in accordance with clause 9.16.1(a)(ii).

STEM Offer: An offer to provide energy through the STEM Auction for a Trading Interval determined by the IMO in accordance with clause 6.9.3.

STEM Settlement Date: The date determined in accordance with clause 9.16.1(b) for settling transactions covered by STEM Settlement Statements.

STEM Settlement Disagreement Deadline: The time determined in accordance with clause 9.16.1(c) by which Notices of Disagreement concerning a STEM Settlement Statement for a Trading Week must be submitted to the IMO.

STEM Settlement Statement: A settlement statement for STEM transactions during a Trading Day issued under clause 9.16.1(a)(i) and containing the information described in clause 9.17.2.

STEM Submission: A submission by a Market Participant to the IMO made in accordance with clause 6.3B containing the information set out in, and in the format prescribed by, clause 6.6.

Chapter 11

Stipulated Default Load: The maximum energy consumption to be maintained by an Interruptible Load, Curtailable Load or Dispatchable Load if activated, as specified in its Reserve Capacity Obligations.

Supplementary Capacity Contract: An agreement under which a service provider agrees to supply one or more Eligible Services to the IMO, entered into in accordance with clause 4.24.

Suspension Event: An event described in clause 9.23.1.

Suspension Notice: A notice issued by the IMO in accordance with clause 2.32 or 9.23.7 that a Market Participant is suspended from trading in the Wholesale Electricity Market.

SWIS: See the South West Interconnected System.

SWIS Operating Standards: The standards for the operation of the SWIS including the frequency and time error standards and voltage standards set out in clause 3.1.

SWIS Operating State: One or any of the Normal Operating State, High Risk Operating State or Emergency Operating State.

SWIS Restricted: An information confidentiality status whereby information or documents may only be made available to the parties described in clause 10.2.2(b).

System Management: A segregated business unit of Western Power Corporation responsible for dispatching the power system.

System Management Confidential: An information confidentiality status whereby information or documents may only be made available to the parties described in clause 10.2.2(e).

System Operation Fees: The fees determined by the IMO in accordance with clause 2.24, and payable by Market Participants for the services provided by System Management.

System Restart: The Ancillary Service described in clause 3.9.8.

Technical Code: A code prescribing technical rules and requirements for access arrangements, established under the Access Code.

Technical Envelope: The limits for the operation of the SWIS in each SWIS Operating State.

Temperature Dependent Load: A Load that is not a Non-Temperature Dependent Load.

Total Amount: Has the meaning given in clause 9.24.3.

Chapter 11

Trading Day: A period of 24 hours commencing at 8:00 AM on any day after Energy Market Commencement, except where the IMO declares that part of a Trading Day is to be treated as a full Trading Day under clause 9.1.1, in which case that part is a Trading Day.

Trading Interval: A period of 30 minutes commencing on the hour or half-hour during a Trading Day.

Trading Limit: Has the meaning given in clause 2.39.1.

Trading Margin: Has the meaning given in clause 2.41.1.

Trading Month: A period from the beginning of a Trading Day commencing on the first day of a calendar month to the end of the Trading Day that finishes on the first day of the following calendar month.

Trading Week: A period from the beginning of a Trading Day commencing on a Thursday, to the end of the Trading Day that finishes on the following Thursday.

Typical Accrual: The amount determined in accordance with clause 2.42.2.

Upward Deviation Administrative Price (UDAP): The amount calculated under clause 6.14.5.

Upward Unauthorised Deviation Quantity (UUDQ): The amount calculated under clause 6.17.3.

Western Power: The body corporate established under the Electricity Corporation Act (1994) as Western Power Corporation.

Wholesale Electricity Market: The market established under section 122 of the Electricity Industry Act.

Wholesale Market Objectives: The market objectives set out in Section of 122(2) of the Electricity Industry Act and repeated in clause 1.2.1.

Appendix 1: Standing Data

This Appendix describes the Standing Data to be maintained by the IMO for use by the IMO in market processes and by System Management in dispatch processes.

Standing Data required to be provided as a pre-condition for Facility Registration, and which is to be updated by Rule Participants as necessary, is described by clauses (a) to (j).

Standing Data not required to be provided as a pre-condition for Facility Registration but that which is required to be maintained by the IMO includes the data described in clauses (k) onwards.

- (a) for a Network:
 - i. positive, negative and zero sequence network impedances for the network elements;
 - ii. information on the network topology;
 - iii. information on transmission circuit limits;
 - iv. information on security constraints;
 - v. overload ratings, including details of how long overload ratings can be maintained; and
 - vi. the short circuit capability of facility equipment.
- (b) for a Scheduled Generator:
 - i. evidence that the communication and control systems required by clause 2.36 are in place and operational;
 - ii. the name plate capacity of the generator, expressed in MW;
 - iiA. the minimum load at the connection point of the generator that will automatically trip off if the generator fails, expressed in MW;
 - iii. the sent out capacity of the generator, expressed in MW;
 - iiiA. the dependence of capacity on the type of fuel used by the facility for each fuel described in (xi);
 - iv. the dependence of capacity on temperature at the location of the facility;
 - v. the normal ramp up and ramp down rates as a function of output level;
 - vi. emergency ramp up and ramp down rates;
 - vii. the over-load capacity of the generator, if any, expressed in MW;
 - viii. the AGC capabilities of the facility;
 - ix. the Black Start capability of the facility;

Appendix 1

- x. the capability to provide each of the following Ancillary Services, including information on trade-off functions when more than one other type of Ancillary Service and/or energy is provided simultaneously:
 - 1. Load Following;
 - 2. Spinning Reserve;
 - 3. [Blank]; and
 - 4. Load Rejection Reserve;

While the Electricity Generation Corporation and (via Ancillary Service Contracts) System Management are expected to provide all Ancillary Services, data on plant capability may still be required for emergency situations.

- xii. details of the fuel or fuels that the facility can use, including dual fuel capabilities and the process for changing fuels;
- xiii. details of any potential energy limits of the facility;
- xiii. the minimum stable loading level of the generator, expressed in MW;
- xiv. the minimum dispatchable loading level of the generator, expressed in MW;
- xv. any output range between minimum dispatchable loading level and name plate capacity in which the facility is incapable of stable or safe operation;
- xvi. sub-transient, transient and steady state impedances (positive, negative and zero sequence) for the facility;
- xvii. the minimum time to synchronisation from each of the following states:
 - 1. cold;
 - 2. warm;
 - 3. hot;and the number of hours that must have elapsed since the facility last ran for it to be considered in each of these states;
- xviii. the minimum time before the facility can be restarted after it is shut down;
- xix. the minimum response time before the facility can begin to respond to an instruction from System Management to change its output;
- xx. the Metering Data Agent for the facility;
- xxi. the single line diagram for the facility, including the locations of transformers, switches, operational and settlement meters;
- xxii. the network nodes at which the facility can connect; and

Appendix 1

xxiii. the short circuit capability of facility equipment.

(c) for a Scheduled Generator not registered to **the Electricity Generation Corporation**:

i. a commitment and decommitment cost data comprising:

1. a whole dollar amount representing the cost of committing the facility, where this amount must represent reasonable costs incurred in the typical start-up as justified by supporting evidence.
2. a whole dollar amount representing the cost of de-committing the facility, where this amount must not exceed the Maximum Shutdown Price multiplied by the minimum dispatchable loading level defined in b(xiv);

ii. [Blank]

iii. [Blank]

iv. [Blank]

v. Standing Balancing Data for Scheduled Generators registered as being capable of running on Non-Liquid Fuel comprising:

1. a Non-Liquid Supply Increase Price for Peak Trading Intervals;
2. a Non-Liquid Supply Increase Price for Off-Peak Trading Intervals;
3. a Non-Liquid Supply Decrease Price for Peak Trading Intervals;
4. a Non-Liquid Supply Decrease Price for Off-Peak Trading Intervals;

where these prices must be not less than the Minimum STEM Price, not more than the Maximum STEM Price, and must be expressed in units of \$/MWh to a precision of \$0.01/MWh; and

vi. Standing Balancing Data for Scheduled Generators registered as being capable of running on Liquid Fuel comprising:

1. a Liquid Supply Increase Price for Peak Trading Intervals;
2. a Liquid Supply Increase Price for Off-Peak Trading Intervals;
3. a Liquid Supply Decrease Price for Peak Trading Intervals;
4. a Liquid Supply Decrease Price for Off-Peak Trading Intervals;

where these prices must be not less than the Minimum STEM Price, not more than the Alternative Maximum STEM Price, and must be expressed in units of \$/MWh to a precision of \$0.01/MWh;

(d) [Blank]

Appendix 1

- (e) for a Non Scheduled Generator:
- i. evidence that the communication and control systems required by clause 2.36 are in place and operational;
 - ii. the name plate capacity of the generator, expressed in MW;
 - iiA. the minimum load at the connection point of the generator that will automatically trip off if the generator fails, expressed in MW;
 - iii. the ramp down rates;
 - iv. the capability to provide Load Rejection Reserve, including information on trade-off functions when energy is provided simultaneously;
 - v. for a facility not registered to the Electricity Generation Corporation a price between the Minimum STEM Price and the Maximum STEM Price in units of \$/MWh expressed to a precision of \$0.01/MWh to be the basis for payments by the Market Participant for decreases in generation in response to a Dispatch Instruction where a different price may be specified for Peak Trading Intervals and Off-Peak Trading Intervals;
 - vi. the minimum response time before the facility can begin to respond to an instruction from System Management to change its output;
 - vii. the Metering Data Agent for the facility;
 - viii. the single line diagram for the facility, including the locations of transformers, switches, operational and settlement meters;
 - ix. the network nodes at which the facility can connect;
 - x. the short circuit capability of facility equipment; and
 - xi. sub-transient, transient and steady state impedances (positive, negative and zero sequence) for the facility;
- (f) for a Market Customer serving Non-Dispatchable Load:
- i. the connection points at which electricity is delivered to the Market Customer including for supply to Customers;
 - ii. the connection points at which the Market Customer holds Arrangements for Access, where evidence of such Arrangements for Access must be provided to the IMO;
 - iii. the Market Customer's nominated maximum consumption quantity, in units of MWh per Trading Interval for each connection point referred to in paragraph (i);

This is the maximum amount that the Market Customer's load could consume in a half-hour dispatch period (which might be considerably less than the Access quantity), and is intended to be used as a default value for the Market Customer's Maximum Consumption Capability.

Appendix 1

- iv. the Metering Data Agent for the Market Customer;
 - v. the metering points at which the quantity of electricity, delivered to the Market Customer is to be measured;
 - vi. the identity of metering points serving Intermittent Loads that are Non-Dispatchable Loads;
 - vii. for each metering point identified in (iv) the maximum allowed level of Intermittent Load, where this cannot exceed the quantity in (iii);
 - viii. for each metering point identified in (vi) the maximum level of net consumption at that meter which is not separately metered and which is not Intermittent Load; and
 - ix. for each metering point identified in (vi) the separately metered generating systems and loads behind that meter which are not to be included in the definition of that Intermittent Load.
- (g) for an Interruptible Load:
- i. the Market Customer's nominated maximum consumption quantity, in units of MWh per Trading Interval;
 - ii. evidence that the communication and control systems required by clause 2.36 are in place and operational;
 - iii. real-time telemetry capabilities;
 - iv. the maximum amount of load that can be interrupted;
 - v. the maximum duration of any single interruption;
 - vi. the capability to provide each of the following Ancillary Services as a function of consumption:
 - 1. Spinning Reserve;
 - 2. [Blank]

No response time needs to be specified as Interruptible Loads response automatically to frequency drops.

- vii. the Metering Data Agent for the facility;
- viii. the single line diagram for the facility, including the locations of transformers, switches, operational and settlement meters;
- ix. the network nodes at which the facility can connect;
- x. the short circuit capability of facility equipment;
- xi. whether the Interruptible Load is an Intermittent Load;
- xii. if the Interruptible Load is an Intermittent Load, the maximum allowed level of Intermittent Load, where this cannot exceed the quantity in (i);

Appendix 1

- xiii. if the Interruptible Load is an Intermittent Load, the maximum level of net consumption behind the meter associated with the Interruptible Load which is not separately metered and which is not Intermittent Load; and
 - xiv. if the Interruptible Load is an Intermittent Load, the separately metered generating systems and loads behind that meter associated with the Interruptible Load which are not to be included in the definition of that Intermittent Load.
- (h) for a Curtailable Load:
- i. the Market Customer's nominated maximum consumption quantity, in units of MWh per Trading Interval;
 - ii. evidence that the communication and control systems required by clause 2.36 are in place and operational;
 - iii. the maximum amount of load that can be curtailed;
 - iv. the maximum duration of any single curtailment;

Details of limits on numbers of interruptions are a contractual issue and are not strictly standing data.

- v. [Blank]
- vi. for a facility that is registered to a Market Participant other than the Electricity Generation Corporation, Standing Balancing Data comprising:
 - 1. a Consumption Decrease Price for Peak Trading Intervals; and
 - 2. a Consumption Decrease Price for Off-Peak Trading Intervals;where these prices must be not less than the Minimum STEM Price, not more than the Alternative Maximum STEM Price, and must be expressed in units of \$/MWh to a precision of \$0.01/MWh;
- vii. the minimum response time before the facility can begin to respond to an instruction from System Management to change its output;
- viii. the Metering Data Agent for the facility;
- ix. the single line diagram for the facility, including the locations of transformers, switches, operational and settlement meters;
- x. the network nodes at which the facility can connect;
- xi. the short circuit capability of facility equipment;
- xii. whether the Curtailable Load is an Intermittent Load;
- xiii. if the Curtailable Load is an Intermittent Load, the maximum allowed level of Intermittent Load, where this cannot exceed the quantity in (i);

- xiv. if the Curtailable Load is an Intermittent Load, the maximum level of net consumption behind the meter associated with the Curtailable Load which is not separately metered and which is not Intermittent Load; and
 - xv. if the Curtailable Load is an Intermittent Load, the separately metered generating systems and loads behind that meter associated with the Curtailable Load which are not to be included in the definition of that Intermittent Load.
- (i) for a Dispatchable Load:
- i. the Market Customer's nominated maximum consumption quantity, in units of MWh per Trading Interval;
 - ii. evidence that the communication and control systems required by clause 2.36 are in place and operational;
 - iii. the dispatchable capacity of the load, expressed in MW;
 - iv. the normal ramp up and ramp down rates as a function of output level;
 - v. emergency ramp up and ramp down rates;
 - vi. the AGC capabilities of the facility;
 - vii. details of any potential Energy Limits of the facility;
 - viii. the minimum dispatchable load level of the facility, expressed in MW;
 - ix. the maximum dispatchable load level of the facility, expressed in MW;
 - x. the capability to provide each of the following Ancillary Services, including information on trade-off functions when more than one other type of Ancillary Service and/or energy is provided simultaneously:
 - 1. Load Following;
 - 2. Spinning Reserve;
 - 3. [Blank]; and
 - 4. Load Rejection Reserve;
 - xA. for a facility that is registered to a Market Participant other than the Electricity Generation Corporation, Standing Balancing Data comprising:
 - 1. a Consumption Increase Price for Peak Trading Intervals;
 - 2. a Consumption Increase Price for Off-Peak Trading Intervals;
 - 3. a Consumption Decrease Price for Peak Trading Intervals; and
 - 4. a Consumption Decrease Price for Off-Peak Trading Intervals;

Appendix 1

where these prices must be not less than the Minimum STEM Price, not more than the Alternative Maximum STEM Price, and must be expressed in units of \$/MWh to a precision of \$0.01/MWh;

- xi. the minimum response time before the facility can begin to respond to an instruction from System Management to change its output;
- xii. the Metering Data Agent for the facility;
- xiii. the single line diagram for the facility, including the locations of transformers, switches, operational and settlement meters;
- xiv. the network nodes at which the facility can connect; and
- xv. the short circuit capability of facility equipment.

These provisions might need to be modified as and when a truly dispatchable load enters the market to reflect the technology used.

(j) [Blank]

(k) For each Registered Facility:

- i. Reserve Capacity information including:
 - 1. the most recent Certified Reserve Capacity of the facility;
 - 2. the Capacity Credits held by the facility;
 - 3. the Reserve Capacity Obligation Quantity of the facility at 41°C (if applicable);
 - 4. the Reserve Capacity Obligation Quantity of the facility at 45°C (if applicable);
 - 5. for Interruptible Loads and Curtailable Loads, the maximum number of times that interruption can be called during the term of the Capacity Credits;
 - 6. the method to be used for determining the ambient temperature at the site of the facility (if applicable); and
 - 7. for each Short Term Special Price Arrangement and Long Term Special Price Arrangement associated with the facility, the number of Capacity Credits covered, the Special Reserve Capacity Price to be applied, and the expiration date and time of the Special Price Arrangement.
- ii. Network Control Service information including:
 - 1. limits on the availability of a facility;
 - 2. the Monthly Availability Payment for the facility; and
 - 3. the identity of the Network Operator required to fund the Monthly Availability Payment; and

Appendix 1

- iii. the Facility Dispatch Tolerance;
- (l) For each Market Customer:
 - i. the Individual Reserve Capacity Requirement for the Market Customer;
 - ii. a list of Non-Temperature Dependent interval meters; and
 - iii. a Standing STEM Submission (if provided by the Market Participant) comprising for each Trading Interval for a Trading Week:
 - 1. a Fuel Declaration;
 - 2. an Availability Declaration;
 - 3. if the Market Participant is a provider of Ancillary Services, an Ancillary Service Declaration;
 - 4. a Portfolio Supply Curve; and
 - 5. a Portfolio Demand Curve; and
- (m) For each Intermittent Facility, whether it is exempted from funding Spinning Reserve costs.

Appendix 2: Spinning Reserve Cost Allocation

This methodology resembles the current allocation of spinning reserves, except that it does not distinguish different stages of spinning reserve.

This Appendix determines the value of $Reserve_Share(p,t)$ of the Spinning Reserve service payment costs in Trading Interval t to be borne by Market Participant p .

In this Appendix the relevant Market Participant p is the Market Participant to whom a facility is registered, with the exception that in the case of unregistered generation systems serving Intermittent Loads, the relevant Market Participant p is the Market Participant to whom the Intermittent Load is registered..

The calculations in this Appendix are based on data for a set of applicable facilities (indexed by f) where this set comprises all Scheduled Generators and all Non-Scheduled Generators registered during Trading Interval t , except those Intermittent Generators exempted under clause 2.30A.2. This set also includes all unregistered generation systems serving Intermittent Loads.

For the purpose of determining the $Reserve_Share(p,t)$ values, each applicable facility f has an applicable capacity associated with it for Trading Interval t .

- If facility f is an Intermittent Generator with an interval meter then this is double the MWh average interval meter reading for the Trading Month containing Trading Interval t .
- If facility f is a Scheduled Generator with an interval meter then this is double the MWh interval meter reading for Trading Interval t .
- If facility f is an Electricity Generation Corporation Intermittent Generator without an interval meter then this is double the average monthly MWh sent out generation of that facility based on SCADA data over the Trading Month containing Trading Interval t .
- If facility f is an Electricity Generation Corporation Scheduled Generator without an interval meter or an unmetered generation system serving Intermittent Load then this is double the MWh sent out generation of that facility based on SCADA data for Trading Interval t .

The methodology makes use of the data in Table 1.

Block Number	Block Range (MW)	Block Size (MW)
1	> 200	100
2	125 - 200	75
3	65 - 125	60
4	45 - 65	20

Appendix 2

5	10 - 45	35
---	---------	----

Table 1: Data for Determine Reserve_Share(p,m)

For each Block, indicated by block number b , in Table 1, the Reserve Block Share is:

$$RBS(b) = [\text{Block Size}(b) / \text{Sum}(i, \text{Block Size}(i))] / \text{Sum}(f(i=b), TIS(f))$$

Where

Block Size(i) is the size of the Block with block number i listed in Table 1.

$f(i=b)$ is the subset of applicable facilities that had applicable capacities for Trading Interval t lying within the block range of any Block with a block number value of b or less.

$TIS(f)$ is 1 if the applicable facility f was synchronised to the SWIS during Trading Interval t , and is zero otherwise.

This is analogous to SRPBlockX on page 9 of the WP document "Support Services Prices for the South West Interconnected System 2003/2004"

For each Block b in Table 1, the Reserve Generator Share is:

$$RGS(b) = \text{Sum}(i=b, RBS(i))$$

Where

$i=b$ is the set of Blocks listed in Table 1 that have a block number i greater than or equal to b .

This is analogous to SRPGenX on page 10 of the WP document "Support Services Prices for the South West Interconnected System 2003/2004"

For each Market Participant p , its unadjusted share of the Spinning Reserve service payment costs for the Trading Interval is:

$$USHARE(p) = \text{Sum}(f(p), RGS(b(f)) \times TIS(f))$$

Where

$f(p)$ is the set of applicable facilities for the Market Participant p that have applicable capacities within one of the block ranges listed in Table 1.

$b(f)$ is the block number of the Block in Table 1 that has a block range that corresponds to the applicable capacity of the applicable facility f .

$TIS(f)$ is 1 if the applicable facility f was synchronised to the SWIS during Trading Interval t , and is zero otherwise.

Note that if Market Participant p has no applicable facilities then $f(p)$ is an empty set so $USHARE(p) = 0$ and in the following equation $\text{Reserve_Share}(p,t) = 0$ so there will be no Spinning Reserve costs allocated to Market Participant p .

Appendix 2

For each Market Participant p , its adjusted share of the Spinning Reserve services payment costs for Trading Interval t is:

$$\text{Reserve_Share}(p,t) = \text{USHARE}(p) / \sum(q, \text{USHARE}(q))$$

Where

q is the index of the set of all Market Participants.

Appendix 3: Reserve Capacity Auction & Trade Methodology

This appendix describes a single algorithm which performs two functions. One version of the algorithm is used to prevent the IMO accepting bilateral trades that have insufficient availability to usefully address the Reserve Capacity Requirement. Another version of the algorithm is used in the conduct of the Reserve Capacity Auction as required by clause 4.19.1.

The parameter “a” denotes the active Availability Class where “a” can have a value of {1, 2, 3, 4}. For the purpose of identifying which capacity can be applied to satisfying capacity requirements the minimum availability of each Availability Class is set to the maximum availability of the next Availability Class. However the algorithms in this appendix allow capacity from an Availability Class with high availability to be used in place of capacity from an Availability Class with lower availability. The following table indicates the required availability of capacity offered for each Availability Class:

Availability Class (i.e. value of “a”)	Minimum Hours of Availability Per Year	Maximum Hours of Availability Per Year
1	96	All
2	72	96
3	48	72
4	24	48

All Certified Reserve Capacity associated with Interruptible Loads, Curtailable Loads or Dispatchable Load is explicitly assigned an Availability Class, whereas all other Certified Reserve Capacity is automatically in Availability Class 1.

The following algorithm applies for both the testing of bilateral trades and for the auction. Terminology that differs in each case is

- “offers”
 - For the testing of bilateral trades the “offer” is a proposed bilateral transaction (as specified in clause 4.14.1 for each Facility or block).
 - For an auction an “offer” is a “Reserve Capacity Offer”.
- the capacity requirements of Availability Class “a”

Appendix 3

- For the testing of bilateral trades, for Availability Class $a = 1$ this is the greater of zero and $Q[a] - X[a]$ while for Availability Classes $a = 2, 3$ or 4 , this is the greater of zero and $(Q[a] - X[a] - Y[a-1])$ where

$Q[a]$ is the quantity associated with Availability Class “a” in clause 4.5.12(c).

$X[a]$ is the total quantity of Certified Reserve Capacity to be provided by Facilities subject to Network Control Service Contracts and by Facilities under Long Term Special Price Arrangements during the period to which the Reserve Capacity Requirement applies, where the capacity is certified as belonging to Availability Class “a” and is not subject to a bilateral trade.

$Y[a]$ represents the amount by which $(X[a] + Y[a-1])$ exceeds $Q[a]$, with the exception that $Y[0] = 0$.

What this means is that if we start with $a = 1$, and the capacity required for that Availability Class $a = 1$ is $Q[1] = 2500$ MW, and we have $X[1] = 100$ MW of Special Price Arrangements we get a maximum capacity requirement to be covered by bilaterals of Availability Class 1 of 2400 MW, and $Y[1] = 0$.

However, if $X[1]$ had been 2600 MW then the maximum capacity requirement to be covered by bilaterals of Availability Class 1 would have been zero, but $Y[1] = 100$, indicating that the Special Price Arrangements associated with Availability Class $a = 1$ are sufficient to cover that whole class, plus 100 MW of lower availability classes.

So if $Q[2] = 300$, for Availability Class 2 we have a requirement of 300 MW. Suppose the value of $X[2] = 0$, indicating that no Special Price Arrangements of that class are held, then the maximum capacity requirement to be covered by bilaterals of Availability Class 2 would be $Q[2] - X[2] - Y[1] = 300 - 0 - 100 = 200$ MW.

- For an auction this is the same as the capacity requirement for the case of bilateral trades except that it is reduced by the amount of capacity accepted as a bilateral trade.

The algorithm is as follows:

Step 1: Start with $a = 1$

Step 2: Let the set of active offers comprise all offers from Availability Class “a”.

Step 2A: In the case of bilateral trade offers, accept offers from operating facilities and facilities under construction and remove them from the set of active offers.

Step 3: Accept offers from the set of active offers in order of

- In the case of testing bilateral schedules, decreasing availability.

Appendix 3

- In the case of the reserve capacity auction, increasing price

until the capacity requirements of Availability Class “a” are fully covered or until there are no offers left unaccepted in the set of active offers.

Where two or more offers are tied with respect to the selection criteria such that accepting all but one of them would result in the total capacity selected exceeding the total capacity requirement of the Availability Class then the tied offers are to be accepted according to the following rules until the tie is resolved.

- In the case of the reserve capacity auction, offers from operating facilities and facilities under construction are to be accepted ahead of facilities that are yet to commence construction; then
- Offers are to be accepted in decreasing order of capacity offered; then
- Offers for capacity that was included in an Expression of Interest are to be accepted ahead of capacity that was not; then
- Offers are to be accepted in the order of the time the offers were received, with the earlier offer being taken first; and then
- Offers are to be accepted in the order the capacity secured Certified Reserve Capacity;

Thus if two offers have the same price, and the same capacity offered, where both facilities are new, and they both approached the expression of interest in the same manner, and only one of them can be accepted, they will be accepted based on when they were certified. Obviously, it is very unlikely that this “first come, first serve” rule would ever be applied.

Step 4: If all offers in the set of active offers have been accepted but the capacity requirements of Availability Class “a” have not been covered, then record the difference as the capacity shortfall for Availability Class “a”.

Step 5: Remove all offers accepted in Step 3 from the set of active offers.

Step 6: If $a = 4$ then go to Step 8A otherwise increase a by 1.

Step 7: Add all offers from Availability Class “a” to the set of active offers.

Step 8: Return to Step 2A.

Step 8A: In the case of the auction only:

- The Reserve Capacity Price must equal the price of the highest priced offer accepted; and

Appendix 3

- In the special case where the Reserve Capacity Price is zero and there are offers with a price of zero that have not been accepted, then accept those offers with zero price.

Step 9: Report the offers accepted

Step 10: For each Availability Class report the capacity shortfall.

- In the case of testing bilateral schedules, this indicates the amount to be procured in the auction.
- In the case of the reserve capacity auction, this indicates the amount to be procured through supplementary capacity auctions.

Step 11: End.

In the case of the auction only:

- While leaving the Reserve Capacity Price unchanged, the IMO must exchange one or more offers not accepted for one or more offers accepted in the auction if
 - the total capacity scheduled in the auction exceeds the Reserve Capacity Auction Requirement by more than 100 MW;
 - the Reserve Capacity Price exceeds zero,
 - the exchange produces the maximum possible reduction in the total value of offers accepted;
 - the exchange does not create an overall Reserve Capacity shortfall where none existed;
 - in the event that a capacity shortfall exists in one or more Availability Classes, the exchange will not shift a shortfall from an Availability Class with low availability to an Availability Class with high availability; and

The previous clause ensures that were we to have a shortage in Availability Class n we do not resolve that shortage by creating a shortage in Availability Class n-1, as this would make the impact of the shortage worse.

- this would not result in an existing facility, or a facility under construction being excluded.

Appendix 4: Maximum Reserve Capacity Price Methodology

This Appendix presents the method for setting the Maximum Reserve Capacity Price allowed under Clause 4.16. Unless otherwise stated, all dollar amounts are in real dollar terms.

The Maximum Reserve Capacity Price to apply for a Reserve Capacity Auction held in calendar year t is PRICECAP[t] where this is to be calculated as:

$$\text{PRICECAP}[t] = k \times (\text{FIXED_O\&M}[t] + \text{ANNUALISED_CAPCOST}[t] / (\text{CAP} / \text{SDF}))$$

Where:

PRICECAP[t] is the Maximum Reserve Capacity Price to apply in a Reserve Capacity Auction held in calendar year t ;

ANNUALISED_CAPCOST[t] is the CAPCOST[t], expressed in Australian dollars in year t , annualised over a 15 year period, using a real pre-tax return to equity equal to the Commonwealth 10 Year Bond Rate (Real) plus a Margin for Equity of 15.1%, a real return to debt equal to the Commonwealth 10 Year Bond Rate (Nominal) plus a Margin for Debt of 1.5%, and a debt to equity ratio of 60:40;

CAP is the capacity of an open cycle gas turbine, expressed in MW;

SDF is the summer derating factor of a new open cycle gas turbine, and equals 1.18;

CAPCOST[t] is the total capital cost, expressed in million Australian dollars in year t , assumed for an open cycle gas turbine power station of capacity CAP; and

FIXED_O&M[t] is the fixed operating and maintenance costs for a typical open cycle gas turbine power station and any associated electricity transmission facilities, expressed in Australian dollars in year t , per MW per year.

k is a factor set so that the net present value of 10 years worth of payments escalated on a CPI-1% basis is equivalent to the payment stream from 10 years worth of an unescalated payments.

This is applied because Long Term Special Price Arrangements are escalated in value on a CPI-1% basis.

The value of CAPCOST[t] is to be calculated as:

$$\text{CAPCOST}[t] = (\text{PC}[t] \times (1 + M) \times \text{CAP} \times (1 + 1.5D + 0.5xD^2)) + \text{TC}[t] + \text{FFC}[t]$$

Where:

Appendix 4

PC[t] is the capital cost of an open cycle gas turbine power station in year t, expressed in Australian dollars in year t per MW;

M is a margin to cover legal, approval, and financing costs and contingencies;

TC[t] is the cost of electricity transmission assets required to connect an open cycle gas turbine power station to the SWIS, plus an estimate of the costs of augmenting the shared network to facilitate the connection of the open cycle gas turbine power station, expressed in Australian million dollars in year t;

FFC[t] is the fixed fuel costs and must represent the fixed costs associated with an on-site liquid storage tank with sufficient capacity for 24 hours of Liquid Fuel including the cost of keeping this tank half full at all times expressed in Australian million dollars in year t; and

D is the real interest rate on debt and equals the Commonwealth 10 Year Bond Rate (real) plus a Margin for Debt of 1.5%. This rate is used to determine the total interest cost by assuming a construction period of two years with 50% of the capital costs incurred in each year.

The value of PC[t] is to be calculated using the following formula:

$$PC[t] = GTP[t-x] \times (USCPI[t] / USCPI[t-x]) \times ER[t,t-x]$$

Where:

GTP[t-x] is double the lowest quoted equipment price of the three open cycle gas turbines with capacities nearest to CAP, quoted in United States dollars per MW, contained in the most recent issue of Gas Turbine World Handbook, or a similar reputable international trade price, current as at year t-x.

The quoted value is doubled as a means of converting turbine equipment costs into turnkey costs of a power station, where the turnkey costs allow for engineering, procurement and construction costs, and allow for enhancements to satisfy environmental restrictions.

USCPI[t] is a forecast, made in year t-x, of the Consumer Price Index - All Urban Consumers (CPI-U) for the United States of America midway through year t as compiled by the United States Bureau of Labor Statistics.

USCPI[t-x] is the actual value of the Consumer Price Index - All Urban Consumers (CPI-U) for the United States of America midway through year t-x as compiled by the United States Bureau of Labor Statistics.

See http://inflationdata.com/inflation/consumer_price_index/CPI.asp

Appendix 4

$ER[t,t-x]$ is the forecast Australian dollar to United States of America dollar exchange rate, made in year $t-x$, for midway through year t , based on the Australian Federal Government's budget forecasts.

x is the number of years prior to year t for which the latest available open cycle gas turbine data is available at the time of calculating the value of $PRICECAP[t]$.

For the first Reserve Capacity Cycle, where $t=2005$, the following values are to be used in evaluating $PRICECAP[2005]$:

the real pre-tax return to equity = 18%

the real return to debt = 5%

CAP = 160 MW

FIXED_O&M[2005] = \$34,000/MW (comprising \$15,000/MW for power station O&M costs and \$19,000/MW for electricity transmission O &M costs)

$M = 15\%$ (comprising a 5% margin associated with legal, approval and financing costs and a 10% margin for contingences).

TC[2005] = \$17 million.

FFC[2005] = \$3 million.

$D = 5\%$

$x = 1$

Appendix 4A: Intermittent Load Individual Reserve Capacity Requirements

This Appendix describes how Individual Reserve Capacity Requirements are derived for Intermittent Loads.

Define:

- MaxL(k) is the nominated load level for Intermittent Load k as specified in clause 4.28.8(c);
- RM is the reserve margin for the Reserve Capacity Cycle defined as negative one plus the ratio of the Reserve Capacity Target for the relevant Capacity Year as described in clause 4.5.10(b)(i) and the expected peak demand for the relevant Capacity Year as described in clause 4.5.10(b)(ii);

Calculate Req(k), which equals MaxL(k) multiplied by RM.

When setting the Intermittent Load Reserve Capacity Requirements in accordance with clause 4.28.7A:

- If Intermittent Load k is registered and operating or the IMO reasonably expects it to be registered and operating during the first Trading Month of the Capacity Year (based on information provided to the IMO in accordance with clause 4.28.8(c)), then set the Intermittent Load Reserve Capacity Requirement for Intermittent Load k equal to Req(k).
- If IMO reasonably expects Intermittent Load k not to be registered or operating during the first Trading Month of the Capacity Year (based on information provided to the IMO in accordance with clause 4.28.8(c)), then set the Intermittent Load Reserve Capacity Requirement for Intermittent Load k equal to zero.

When revising Intermittent Load Reserve Capacity Requirements in accordance with clause 4.28.11, and after allowing for additional nominations by Intermittent Loads that have commenced operation during the Capacity Year:

- If Intermittent Load k is registered and operating or the IMO reasonably expects it to be registered and operating during the next Trading Month to commence during the Capacity Year (based on information provided to the IMO in accordance with clause 4.28.8A), then set the Intermittent Load Reserve Capacity Requirement for Intermittent Load k equal to Req(k).
- If IMO reasonably expects Intermittent Load k not to be registered or operating during the next Trading Month to commence during the Capacity Year (based on information provided to the IMO in accordance with clause 4.28.8A), then set the Intermittent Load Reserve Capacity Requirement for Intermittent Load k equal to zero.

Appendix 4A

Thus if an Intermittent Load was registered and operating from the start of the Capacity Year and its Market Customer nominates that it requires Reserve Capacity for its 100 MW of intermittent load, and if the Reserve Margin is 15%, then the Market Customer will face an Individual Reserve Capacity Requirement of 15 MW. This will be settled based on the prevailing Reserve Capacity price unless the Market Customer procures capacity bilaterally. If the Intermittent Load was registered and commenced operating during the third Trading Month of the Capacity Year then the Market Customer will only face an Individual Reserve Capacity Requirement of 15 MW from the start of the third Trading Month of the Capacity Year.

Appendix 5: Individual Reserve Capacity Requirements

This Appendix presents the method for annually setting and monthly adjusting Individual Reserve Capacity Requirements.

For the purpose of this Appendix:

- all references to meters are interval meters.
- the Notional Wholesale Meter is to be treated as a registered interval meter measuring Temperature Dependent Load. This meter is denoted by Temperature Dependent Load meter $v=v^*$.
- the meter registration data to be used in the calculations is to be the most current complete set of meter registration data as at the time of commencing the calculations.

The steps 1 to 5 describe how the Individual Reserve Capacity Requirement to apply for the first Trading Month of the Capacity Year is set. Steps 7 to 10 describe how this value is updated in each subsequent month.

STEP 1: Define the 12 peak Trading Intervals during the preceding Hot Season as corresponding to the 3 highest demand Trading Intervals on each of the 4 days with the highest daily demand, where demand refers to total demand, net of embedded generation, in the SWIS.

STEP 2: For each meter, u , measuring Non-Temperature Dependent Load determine $NTDL(u)$ and $d(u,i)$, where:

$NTDL(u)$ is the contribution to the system peak load of meter u during the preceding Hot Season where this contribution is double the median value of the metered consumption during the 12 peak Trading Intervals; and

$d(u,i) = 1$ if meter v is registered to Market Customer i and is not measuring Intermittent Load, $d(u,i) = 0$ otherwise.

The doubling of quantities in steps 2 and 3 is required to convert MWh metered quantities into equivalent MW quantities.

STEP 3: For each meter, v , measuring Temperature Dependent Load determine $TDL(v)$ and $d(v,i)$, where:

Appendix 5

TDL(v) is the contribution to the system peak load of meter v during the preceding Hot Season where this contribution is double the median value of the metered consumption during the 12 peak Trading Intervals; and

$d(v,i) = 1$ if meter v is registered to Market Customer i and is not measuring an Intermittent Load, $d(v,i) = 0$ otherwise.

STEP 4: For each Intermittent Load meter w set its Individual Intermittent Load Reserve Capacity Requirement, IILRCR(w), to equal the amount defined in accordance with clause 4.28.7A.

STEP 5: For each Market Customer, i, calculate

$$\text{NTDLRCR}(i) = \text{Sum}(u, \text{NTDL}(u) \times d(u,i)) \times \text{NRR}/\text{FL}$$

$$\text{TDLRCR}(i) = (\text{Sum}(v, \text{TDL}(v) \times d(v,i)) - \text{DSM}(i)) \times (\text{NRR} - \text{Sum}(j, \text{NTDLRCR}(j))) / (\text{Sum}(j, \text{Sum}(v, \text{TDL}(v,j)) - \text{DSM}(j)))$$

$$\text{ILRCR}(i) = \text{Sum}(w, \text{IILRCR}(w) \times d(w,i))$$

$$\text{NRR} = \text{RR} - \text{Sum}(i, \text{ILRCR}(i))$$

where

- j indicates Market Customers
- ILRCR(i) is the Intermittent Load Reserve Capacity Requirement for Market Customer i.
- RR is the Reserve Capacity Requirement
- FL is the peak demand associated with that Reserve Capacity Requirement as specified in clause 4.6.2.
- DSM(i) is the MW quantity of additional Demand Side Management demonstrated and agreed by the IMO to be available by the next Hot Season

This last clause effectively pro-rates the Reserve Capacity Requirement not associated with the Non Temperature Dependent Loads amongst Market Customers in proportion to the previous loads that are temperature dependent after allowing for future demand side measures. The total Reserve Capacity associated with Intermittent Loads is deducted from the Reserve Capacity Requirement (RR) so that we get no double counting. We do not similarly deduct this capacity from the forecast peak demand (FL) because the Reserve Capacity to cover Intermittent Loads is only intended to cover the system's reserve margin, not the original load itself.

STEP 6: The Individual Reserve Capacity Requirement of Market Customer i for the first Trading Month of a Capacity Year is the sum of NTDLRCR(i), TDLRCR(i) and ILRCR(i).

Appendix 5

STEP 7: For Trading Month $n = 1$ (where $n = 12$) identify meters that were not registered with the IMO at the time of determining the Individual Reserve Capacity Requirement for Trading Month 1 but which were registered by the start of Trading Month n .

In other words we only consider meters which were not included in the initial calculation but for which data was available for all of Trading Month n .

For a new meter u that measures Non-Temperature Dependent Load set $NMNTCR(u)$ equal to the Contractual Maximum Demand associated with that meter if the consumption at that meter has a Contractual Maximum Demand figure specified in its Arrangement for Access, otherwise set $NMNTCR(u)$ to be 1.1 times the MW figure formed by doubling the maximum Trading Interval demand for that meter during Trading Month n .

For a new meter v that measures Temperature Dependent Load set $NMTDCR(v)$ equal to the Contractual Maximum Demand associated with that meter if the consumption at that meter has a Contractual Maximum Demand figure specified in its Arrangement for Access, otherwise set $NMTDCR(v)$ to be 1.1 times the MW figure formed by doubling the maximum Trading Interval demand for that meter during Trading Month n .

For a new meter w that measures Intermittent Load set $IILRCR(w)$ in accordance with Appendix 4A to the value applicable to Trading Month n .

Identify the set NM of all those new meters v that measured consumption by a load during Trading Month n where the consumption of that same load was measured by meter $v=v^*$ during all or some of Trading Month $n-1$ and set $WMTDL(v,n)$ for meter $v=v^*$ to equal:

- in the case of Trading Month $n=1$:
$$WMTDL(v^*,n) = TDL(v^*) - \text{Sum}(v \in NW, NMTDCR(v))$$
- in the case of Trading Month $n=1$:
$$WMTDL(v^*,n) = WNTDL(v^*,n-1) - \text{Sum}(v \in NW, NMTDCR(v))$$

STEP 8: Update the values of $d(u,i)$ for Non-Temperature Sensitive Load, $d(v,i)$ for Temperature Dependent Loads and $d(w,i)$ for Intermittent Loads such that:

- $d(u,i)$ has a value of zero if meter u measures Intermittent Load or was not registered to Market Customer i during Trading Month n , otherwise it has a value equal to the number of full Trading Days the meter was registered to Market Customer i in Trading Month n divided by the number of days in Trading Month n .
- $d(v,i)$ has a value of zero if meter v measures Intermittent Load or was not registered to Market Customer i during Trading Month n , otherwise it has a value equal to the number of full Trading Days the meter was registered to Market Customer i in Trading Month n divided by the number of days in Trading Month n .
- $d(w,i)$ has a value of zero if meter w was not registered to Market Customer i during Trading Month n , otherwise it has a value of one if Market Customer i nominated

Appendix 5

capacity for the Intermittent Load measured by meter w in accordance with clause 4.28.8(c), with the exception that if the Intermittent Load was for Load at a meter registered to Market Customer i for only part of Trading Month n , then it has a value equal to the number of full Trading Days that meter was registered to Market Customer i in Trading Month n divided by the number of days in Trading Month n .

So, for a month with 30 days, if meter u was registered to Market Customer A for 10 days, for Market Customer B for 20 days and Market Customer C for 0 days then $d(v,A)=0.33$, $d(v,B)=0.66$ and $d(v,C) = 0$, unless this meter was an Intermittent Load meter in which case all values would be zero. The value of $d(w,i)$ is determined in the same way but the definition is modified to account for the treatment of Intermittent Loads.

Note that meters that have been de-registered will have a $d(v,i)$ or $d(u,i)$ value of 0 for all Market Customers. If Load ceases to be Intermittent Load then $d(w,i)$ will be zero for all Market Customers

STEP 9: For each Market Customer, i , calculate

$NTDLRCR(i)^*$, $TDLRCR(i)^*$, $ILRCR(i)^*$ as the values of $NTDLRCR(i)$, $TDLRCR(i)$ and $ILRCR(i)$, respectively, in STEP 5 recalculated using the identical equations and data as used in STEP 5 but using the $d(u,i)$, $d(v,i)$, $d(w,i)$ and $IILRCR(w)$ values applicable to Trading Month n , using $WNTDL(v^*,n)$ in place of $NTL(v^*)$ only for meter $v=v^*$, and setting $NTDL(u)$ and $TDL(v)$ to be zero for any meters not registered at the time of the original STEP 5 calculation. Note that $IILRCR(w)$ is updated monthly in accordance with clause 4.28.11 and Appendix 4A.

$$X(i) = \text{Sum}(i, ILRCR(i)^* + NTDLRCR(i)^* + TDLRCR(i)^*) + \text{Sum}(u, NMNTCR(u) \times d(u,i)) + \text{Sum}(v, NMTDCR(v) \times d(v,i))$$

The first three terms in $X(i)$ reflect the IRCR for Market Customer i associated with meters and **intermittent** loads. The last two terms are the contribution of new meters.

STEP 10: The Individual Reserve Capacity Requirement of Market Customer i for Trading Month n of a Capacity Year equals $(X(i) \times RR/Y)$ where

- $Y = \text{Sum}(i, X(i))$
- RR is the Reserve Capacity Requirement

This equation should generally have the effect that as demand grows during a year, the monthly cost of reserve capacity associated with load that has existed all year will decline. Note also that if a load disappears then the reserve capacity it funded will be allocated amongst all Market Customers in proportion to their capacity requirements.

Appendix 6: STEM Bid ,STEM Offer and MCAP Price Curve Determination

The first part of this appendix describes a process for converting a Market Participant's Portfolio Supply Curve and Portfolio Demand Curve into a single STEM Price Curve and to then convert a Market Participant's STEM Price Curve into STEM Bids and STEM Offers relative to its Net Bilateral Position.

Clause 6.9.4 states that no STEM Bids or Offers or MCAP Price Curves are to be determined if the IMO has recorded that the Market Participant has not made a STEM Submission.

For each Market Participant and for each Trading Interval in the Trading Day except those for which the IMO has recorded that the Market Participant has not made a STEM Submission:

- (a) Determine for every price between the Minimum STEM Price and the Alternative Maximum STEM Price:
 - i. the maximum cumulative quantity the Market Participant is prepared to sell into the STEM from all of its Price-Quantity Pairs in its Portfolio Supply Curve;
 - ii. the minimum cumulative quantity the Market Participant is prepared to sell into the STEM from all of its Price-Quantity Pairs in its Portfolio Supply Curve;
 - iii. the maximum cumulative quantity the Market Participant is prepared to buy from the STEM from all of its Price-Quantity Pairs in its Portfolio Demand Curve;
 - iv. the minimum cumulative quantity the Market Participant is prepared to buy from the STEM from all of its Price-Quantity Pairs in its Portfolio Demand Curve;
 - v. the STEM Price Curve quantity for that price where
 1. the minimum STEM Price Curve quantity for that price equals the value in (ii) less the value in (iii);
 2. the maximum STEM Price Curve quantity for that price equals the value in (i) less the value in (iv); and
 3. the STEM Price Curve for that price includes all quantities between those in (1) and (2).

Appendix 6

Suppose we have a Portfolio Supply Curve comprising the following Price Quantity Pairs: 20 MWh @ \$50/MWh and a Portfolio Demand Curve comprising the following Price Quantity Pairs 5 MWh @ \$50/MWh, 10 MWh @ \$100/MWh.

At a price above \$100 the values in (a) are (i) 20 (ii) 20 (iii) 0 (iv) 0 so $v(1) = 20$, $v(2)=20$. Hence at any price above \$100 up to the Alternative Maximum STEM Price the STEM Price Curve quantity is +20 MWh, meaning that the participant is a net supplier of 20 MWh.

At a price of \$100 the values in (a) are (i) 20 (ii) 20 (iii) 10 (iv) 0 so $v(1) = 10$, $v(2)=20$. Hence at price of \$100 the STEM Price Curve quantity is all values between +10 MWh and +20 MWh.

At a price of \$51 the values in (a) are (i) 20 (ii) 20 (iii) 10 (iv) 10 so $v(1) = 10$, $v(2)=10$. Hence at price of \$51 the STEM Price Curve quantity is +\$10 MWh.

At a price of \$50 the values in (a) are (i) 20 (ii) 0 (iii) 15 (iv) 10 so $v(1) = -15$, $v(2)=10$. Hence at price of \$50 the STEM Price Curve quantity is all values between - 15 MWh and +10 MWh. That is, at a price of \$50/MWh the supply could be 20 MWh and demand 10 MWh (STEM Price Curve quantity +10 MWh) or supply could be 0 MWh and demand could be 15 MWh (STEM Price Curve Quantity of - 10 MWh).

At a price below \$50 the values in (a) are (i) 0 (ii) 0 (iii) 15 (iv) 15 so $v(1) = -15$, $v(2)=-15$. Hence at any price below \$50 down to the Minimum STEM Price the STEM Price Curve quantity is -15 MWh, meaning that the Market Participant is a net consumer.

- (b) If the minimum quantity in a STEM Price Curve is greater than the Net Bilateral Position of the Market Participant then extend the STEM Price Curve to include the range between the Net Bilateral Position and the minimum quantity in the STEM Price Curve where this range is priced at the Minimum STEM Price.

If a Market Participants Net Bilateral Position is 15 MWh and their STEM Price Curve covers the range 20 MWh to 100 MWh then this will be interpreted as meaning that the participant is prepared to sell 5 MWh as a price taker. That is, the participant is prepared to supply 5 MWh at any price, so should be scheduled. Hence we extend the STEM Price Curve to start at 15 MWh where the first 5 MWh is priced at the Minimum STEM Price. Likewise if the Net Bilateral Position were -15 MWh and the STEM Price Curve minimum was -10 MWh then a the curve would be extended to start at -15 MWh.

- (c) If the maximum quantity in a STEM Price Curve is less than the Net Bilateral Position of the Market Participant then extend the STEM Price Curve to include the range between the maximum quantity in the STEM Price Curve and the Net Bilateral Position where this range is priced at the Alternative Maximum STEM Price.

Appendix 6

If a Market Participant's Net Bilateral Position is 15 MWh and their STEM Price Curve covers the range 0 MWh to 10 MWh then this will be interpreted as meaning that the participant is prepared to buy 5 MWh as a price taker. Hence we extend the STEM Price Curve to end at 15 MWh where the last 5 MWh is priced at the Alternative Maximum STEM Price. That is, the participant is prepared to pay any price to buy out of this position. Likewise if the Net Bilateral Position were -15 MWh and the STEM Price Curve maximum was -20 MWh then the curve would be extended to start at -15 MWh.

- (d) If the Net Bilateral Position equals the minimum STEM Price Curve quantity then there are no STEM Bids, otherwise:
- i. for the STEM Price Curve between the minimum STEM Price Curve quantity and the Net Bilateral Position of that Market Participant identify each price for which more than one STEM Price Curve quantity is defined;
 - ii. for each price identified in (i) identify the minimum STEM Price Curve quantity for which that price applies, such that the STEM Price Curve quantity lies between the minimum STEM Price Curve quantity and the Net Bilateral Position;
 - iii. for each price identified in (i) identify the maximum STEM Price Curve quantity for which that price applies, such that the STEM Price Curve quantity lies between the minimum STEM Price Curve quantity and the Net Bilateral Position;
 - iv. for each price identified in (i) set a Price-Quantity Pair price equal to that price;
 - v. for each price identified in (i) set a Price-Quantity Pair quantity equal to the quantity defined in (iii) less the quantity defined in (ii);
 - vi. set the Market Participant's STEM Bids to be the set of Price-Quantity Pairs defined in (iv) and (v) where each Price-Quantity Pair means that the Market Participant is prepared to buy a quantity of energy from the STEM for that Price-Quantity Pair equal to:
 1. 0 MWh if the STEM Clearing Price is greater than the Price-Quantity Pair price;
 2. the Price-Quantity Pair quantity if the STEM Clearing Price is less than the Price-Quantity Pair price;
 3. an amount between 0 MWh and the Price-Quantity Pair quantity if the STEM Clearing Price equals the Price-Quantity Pair price;
- (e) If the Net Bilateral Position equals the maximum STEM Price Curve quantity then there are no STEM Offers, otherwise:
- i. for the STEM Price Curve between the Net Bilateral Position of that Market Participant and the maximum STEM Price Curve quantity

Appendix 6

identify each price for which more than one STEM Price Curve quantity is defined;

- ii. for each price identified in (i) identify the minimum STEM Price Curve quantity for which that price applies, such that the STEM Price Curve quantity lies between the Net Bilateral Position and the maximum STEM Price Curve quantity;
- iii. for each price identified in (i) identify the maximum STEM Price Curve quantity for which that price applies, such that the STEM Price Curve quantity lies between the minimum STEM Price Curve quantity and the Net Bilateral Position;
- iv. for each price identified in (i) set a Price-Quantity Pair price equal to that price;
- v. for each price identified in (i) set a Price-Quantity Pair quantity equal to the quantity defined in (iii) less the quantity defined in (ii);
- vi. set the Market Participant's STEM Offers to be the set of Price-Quantity Pairs defined in (iv) and (v) where each Price-Quantity Pair means that the Market Participant is prepared to sell a quantity of energy into the STEM for that Price-Quantity Pair equal to:
 1. 0 MWh if the STEM Clearing Price is less than the Price-Quantity Pair price;
 2. the Price-Quantity Pair quantity if the STEM Clearing Price is greater than the Price-Quantity Pair price;
 3. an amount between 0 MWh and the Price-Quantity Pair quantity if the STEM Clearing Price equals the Price-Quantity Pair price;

Suppose the STEM Price Curve is:

-10 MWh for a price less than \$10/MWh

-10 MWh to +5 MWh for \$10/MWh

+5 MWh for a price between \$10/MWh and \$20/MWh

+5 MWh to +20 MWh for \$20/MWh

+20 MWh for a price between \$20/MWh and \$40/MWh

+20 MWh to +100 MWh for a price of \$40/MWh

+100 MWh for a price more than \$40/MWh

Appendix 6

If the Net Bilateral Position is -5 MWh then for STEM Bids we have more than one STEM Price Curve quantity defined for a price of \$10/MWh, while for STEM Offers we have more than one STEM Price Curve quantity defined for prices of \$10/MWh, \$20/MWh and \$40/MWh.

STEM Bids: $(-5) - (-10) = 5$ MWh @ \$10/MWh

STEM Offers: $(+5) - (-5) = 10$ MWh @ \$10/MWh,

STEM Offers: $(+20) - (+5) = 15$ MWh @ \$20/MWh,

STEM Offers: $(+40) - (+20) = 20$ MWh @ \$40/MWh,

Note that if a Market Participant submits a Demand Portfolio Curve with no quantities in it, such that the STEM Price Curve only reflects a Supply Portfolio Curve with a range of 0 to 100 MWh and the Net Bilateral Position is 40 MWh, then the Market Participant will have 40 MWh of STEM Bids and 60 MWh of STEM Offers. Thus STEM Bids can be generated even if no demand is bid into the STEM. In this situation the STEM will be performing economic trading between generators, clearing STEM Offers with prices below the STEM Clearing Price and STEM Bids with prices above the STEM Clearing Price.

The second part of this appendix describes a process for converting all Market Participant Portfolio Supply Curves into a single MCAP Price Curve.

For each Trading Interval in the Trading Day:

- (f) Determine for every price between the Minimum STEM Price and the Alternative Maximum STEM Price:
 - i. the sum over all Market Participants except those recorded as not making a STEM Submission for the Trading Interval of the maximum cumulative quantity the Market Participant is prepared to sell into the STEM from all of its Price-Quantity Pairs in its Portfolio Supply Curve;
 - ii. the sum over all Market Participants except those recorded as not making a STEM Submission for the Trading Interval of the minimum cumulative quantity the Market Participant is prepared to sell into the STEM from all of its Price-Quantity Pairs in its Portfolio Supply Curve;
 - iii. the MCAP Price Curve quantity for that price where
 1. the minimum MCAP Price Curve quantity for that price equals the value in (ii);
 2. the maximum MCAP Price Curve quantity for that price equals the value in (i); and
 3. the MCAP Price Curve for that price includes all quantities between those in (1) and (2).

Appendix 7: Dispatch Schedule Calculation

The process in this appendix defines the Dispatch Schedule for a Market Participant, other than **the Electricity Generation Corporation**, that has received a Dispatch Instruction from System Management during a Trading Interval.

Where the IMO must calculate the Dispatch Schedule for a Market Participant's Scheduled Generator or Dispatchable Load under clause 6.15.1(b), it must use the following process.

Each Dispatch Instruction can be considered as having two ramp rates

- The ramp rate specified in the Dispatch Instruction that applies from the time when response to the Dispatch Instruction is required to commence until the time when the target output level is reached; and
- A ramp-rate of zero once the target output level is reached.

For each Trading Interval, define a set of time intervals within the Trading Interval during which different ramp-rates apply.

From $n=0$ to $n=N$, $t(n)$ is the time in minutes from which Ramp Rate(n), in MW/minute applies

- $t(0) = 0$
- if a new Dispatch Instruction is issued its ramp-rate applies from the time when response to the Dispatch Instruction is required to commence, overriding a previous Dispatch Instruction
- $t(N) = 30$

FOL(0) is the initial net output level in MW as at the start of the Trading Interval, where FOL(0) is positive valued for supply and negative valued for consumption.

FOL(0) is determined from either:

- the Resource Plan value, or
- where a Dispatch Instruction applied at the beginning of the Trading Interval, from the previous Trading Interval's FOL(N) calculation

$$\text{FOL}(n+1) = \text{FOL}(n) + \text{Ramp Rate}(n) \times (t(n+1) - t(n))$$

Then:

$$\text{Dispatch Schedule} = 0.5 \times \text{Sum}[n=1 \text{ to } N, (\text{FOL}(n-1) + \text{FOL}(n)) \times (t(n) - t(n-1)) / 30]$$

Appendix 8: Top-up and Spill Rules

PREFACE

The first steps towards electricity reform were based on providing open access to Western Power's electricity transmission and distribution systems so that Independent Power Producers (IPPs) could directly supply customers whose demand exceeds the contestability threshold level. One requirement placed upon IPPs was that they balance their generation output with their load demands at all times. This required investment in load following equipment that made supply to smaller customers, those with demand less than a few megawatts, uneconomic. In recognition that perfect balancing was not possible, some tolerance was permitted but any imbalance beyond relatively low levels could incur significant costs.

In November 2002, Government accepted a recommendation from the Electricity Reform Task Force that Western Power be required to provide an improved transitional balancing service, a Top-up and Spill service, until the reformed electricity market, including a new balancing service, is fully operational. (ERTF Recommendation 76.)

In June 2004, Government introduced the Top-up and Spill (TUAS) market which allowed members to purchase top-up energy from Western Power when their production was below the level of their customer demand, and to sell spill energy to Western Power when their production exceeded demand. The TUAS rules detailed the rights and obligations of members under the TUAS market rules, including Western Power as the market service provider, and outlined the pricing arrangements and operating procedures.

With the implementation of the Wholesale Electricity Market Rules, the 25 June 2004 TUAS rules have been withdrawn and the Top-Up and Spill Market Rules as outlined in this appendix of the Wholesale Electricity Market Rules now apply.

These rules have effect under Part 9 of the *Electricity Industry Act 2004*, and apply to the South West Interconnected System.

Western Power is required by these rules to manage and operate the TUAS market. The Minister will be responsible for ensuring Western Power's compliance with these rules.

The TUAS market is designed to accommodate the requirements of both renewable and non-renewable generators, including the specific requirements of intermittent renewable generators. However, it is not to be used for the provision of "part-supply" and the quantity of top-up that may be taken by an intermittent renewable generator is limited to the generator's expected annual output.

The TUAS market is intended to operate as an alternative to and an extension of the existing balancing arrangements under the *Electricity Transmission Regulations 1996* and *Electricity Distribution Regulations 1997*. The TUAS market makes cost neutral balancing available to

Appendix 8

IPPs at pre-published prices. More significantly, the TUAS market enables IPPs to intentionally vary their generation from customer load requirements by trading electricity where it is commercially attractive to do so.

The Interim TUAS market provides an important step towards the implementation of the Wholesale Electricity Market (WEM). The WEM will be implemented progressively and it is expected that some two years will be required to develop and test the necessary systems for the longer term trading and balancing arrangements. To cover this period of time, the TUAS market rules will provide a transitional arrangement. The TUAS market will cease operation when the WEM balancing and trading arrangements commence.

Members and prospective members should take these planned changes into account when making contracting and investment decisions in connection with these rules.

These rules can be examined and downloaded at Western Power's internet site: www.westernpower.com.au.

Appendix 8: Chapter 1 – Introductory

Definitions

1.1 In these rules, unless the contrary intention appears from the context:

“**access contract**” means a “distribution access agreement” as defined in the *EDR* or an “access agreement” as defined in the *ETR*.

Note: At the time these rules commenced, the definition in regulation 3 of the *EDR* was:

“ ‘**distribution access agreement**’ in respect of a user, means:

- (a) if the user is not Western Power, then an agreement entered into between Western Power and the user under these regulations, under which Western Power agrees to provide distribution access services to the user; and
- (b) if the user is Western Power, then a deemed distribution access agreement provided for by regulation 15(2) or 52(8).”

At the time these rules commenced, the definition in regulation 3 of the *ETR* was:

“ ‘**access agreement**’ in respect of a user, means:

- (a) if the user is not Western Power, then an agreement between Western Power and the user, under which Western Power agrees to provide access services to the user; and;

Appendix 8

- (b) if the user is Western Power, then a deemed access agreement provided for by regulation 15(2) or 49(1) under which Western Power as a user is provided with access services.”

“**accepted nomination**” means a *nomination* which has been accepted under rule 3.18 or rule 3.19(d) for a half hour in a *supply day*.

“**access regulations**” means:

- (a) to the extent that the *member’s access contract* incorporates or is governed by the *ETR* — the *ETR*; and
- (b) to the extent that the *member’s access contract* incorporates or is governed by the *EDR* — the *EDR*.

“**administration fee**” means the fee charged by the *market service provider* and payable by a *member* under rule 5.11.

“**applicant**” has the meaning given to it in rule 2.2 or rule 8.1 as applicable.

“**application**” means an application under rule 2.2.

“**appointee**” means a person appointed to the *TUAS consultation group* in accordance with Chapter 11.

“**auditor**” means a person appointed to conduct an audit under clause A2.1 or clause A2.24.

“**arbitrator**” has the meaning given to it in section 61 of the *Gas Pipelines Access (Western Australia) Act 1998*.

“**balancing band**” means a band defined in rule 3.28.

“**balancing month**” means the month over which balancing is calculated under the *access regulations*.

“**balancing price list**” means the list of prices prepared and published by the *market service provider* under rule 4.2(a) specifying prices for *balancing electricity* and comprising under these rules either a *normal price list*, a *high price list*, or a *liquids price list*.

“**balancing electricity**” is defined in rule 3.6(b) and means *balancing top-up electricity* or *balancing spill electricity*.

“**balancing spill electricity**” means the electricity accepted by the *market service provider* from a *member* as defined in rule 3.6(b)(ii).

“**balancing spill price**” means the applicable price for *balancing spill electricity* determined under rule 4.6 from the prices specified in a *balancing price list*.

“**balancing top-up electricity**” means the electricity supplied by the *market service provider* to a *member* as defined in rule 3.6(b)(i).

“**balancing top-up price**” means the applicable price for *balancing top-up electricity* determined under rule 4.6 from the prices specified in a *balancing price list*.

Appendix 8

“**business day**” means a day that is not a Saturday, Sunday or a public holiday in Western Australia.

“**communication**” means a notice, approval, consent or other communication given or made under these rules.

“**conflict of interest**” is defined in clause A2.4.

“**connection assets**” means all of the network assets that are used only in order to transfer electricity into or out of a network at the relevant connection point and includes any transformers or switchgear at the relevant point, or which is installed to support or to provide backup to, such electrical equipment as is necessary for that transfer.

“**connection point**” means an *entry point*, *exit point* or *transfer point*.

“**CMD**” or “**contract maximum demand**” for a *connection point* means the maximum amount of electricity that the *member* may transfer out of the *network* at the *connection point* being either:

- (a) the amount specified in the *member's access contract* from time to time in respect of the *connection point*, or
- (b) if no amount is specified in the *member's access contract*, the maximum amount of electricity permitted to be transferred through the *connection assets* at the *connection point* under the *technical code*.

“**default**” means any event or thing which is a default as defined in rule 6.1.

“**default of payment**” means the *default* specified in rule 6.1(a).

“**dispatchable generator**” means any generator other than an *intermittent renewable generator*.

“**dispatchable plant**” means any plant used to generate electricity other than *intermittent renewable plant*.

“**DSOC**” means the amount notified from time to time as declared sent out capacity in respect of a *connection point* under a *member's access contract*.

“**economic cost neutrality**” is defined in rules 5.1 to 5.3.

“**EDR**” means the *Electricity Distribution Regulations 1997*.

“**entry point**” has the meaning given to it in the *access regulations*.

Note: At the time these rules commenced, the definition in regulation 3 of the *EDR* was:

“ ‘**entry point**’ means:

a connection at which electricity is more likely to be transferred to the electricity distribution network or the electricity transmission network (as the case requires) than to be transferred from the electricity distribution network or the electricity transmission network (as the case requires).”

Appendix 8

At the time these rules commenced, the definition in regulation 3 of the *ETR* was:

“**‘entry point’** means:

a connection at which electricity is more likely to be transferred to the electricity transmission network than to be transferred from the electricity transmission network.”

“**ETR**” means the *Electricity Transmission Regulations 1996*.

“**excluded EDR provision**” is defined in rule 3.41.

“**excluded ETR provision**” is defined in rule 3.38.

“**exit point**” has the meaning given to it in the *access regulations*.

Note: At the time these rules commenced, the definition in regulation 3 of the *EDR* was:

“**‘exit point’** means:

a connection at which electricity is more likely to be transferred from the electricity distribution network or the electricity transmission network (as the case requires) than to be transferred to the electricity distribution network or the electricity transmission network (as the case requires).”

At the time these rules commenced, the definition in regulation 3 of the *ETR* was:

“**‘exit point’** means:

a connection at which electricity is more likely to be transferred from the electricity transmission network than to be transferred to the electricity transmission network.”

“**expiry date**” means the date upon which *an imbalance default notice* expires and is determined in accordance with rules 6.12 and 6.13.

“**forecast production data**” means data of the type specified in the *operating procedures*, which is to be provided in accordance with rule 3.25.

“**former member**” means a *member* who has cancelled its *membership* under rule 2.14.

“**general default notice**” means a notice given in accordance with rule 6.6.

“**good electricity industry practice**” has the meaning given to it in the *access regulations*.

Note: At the time these rules commenced, the definition in regulation 30(1) of the *EDR* was:

“Good electricity industry practice means the exercise of that degree of skill diligence, prudence and foresight that reasonably would be expected from a significant proportion of operators of facilities forming part of a power system for the generation,

Appendix 8

transmission, distribution or supply of electricity under conditions comparable to those applicable to the relevant facility consistent with applicable laws, these regulations, the Distribution Technical Code, licences, codes, reliability, safety and environmental protection.”

At the time these rules commenced, the definition in regulation 28(1) of the *ETR* was:

“Good electricity industry practice means the exercise of that degree of skill, diligence, prudence and foresight that reasonably would be expected from a significant proportion of operators of facilities forming part of a power system for the generation, transmission or supply of electricity under conditions comparable to those applicable to the relevant facility consistent with applicable laws, these regulations, the Technical Code, licences, codes, reliability, safety and environmental protection.”

“**high price day**” means a day to which, in accordance with *the operating procedures*, a *high price list* applies.

“**high price list**” means a *price list* prepared and *published* by the *market service provider* under rule 4.2(a)(ii) or 4.2(b)(ii)

“**imbalance**” is defined in rule 3.29.

“**imbalance default notice**” means a notice given in accordance with rule 6.11.

“**interested person**” means a *member*, a person who has made a submission to the Minister under rule 12.2 or any other person with a legitimate interest in the *TUAS market* who has notified the Minister of its interest.

“**intermittent renewable generator**” is defined in rule 7.1.

“**intermittent renewable plant**” means generating plant (powered by a renewable energy source) used by an *intermittent renewable generator* to generate electricity.

“**level**” means the degree of rigour with which a *negative assurance audit* is undertaken as defined in A2.15.

“**liquids**” means a liquid fuel (including fuel oil and distillate) used as fuel in:

- (a) the *market service provider’s* generating plant; or
- (b) other plant in respect of which the *market service provider* has a contractual arrangement to pay the plant owner or operator to use a liquid fuel, for the purposes of maintaining the secure and reliable operation of the SWIS.

“**liquids event**” means a period of time to which, in accordance with the *operating procedures*, a *liquids price list* applies.

“**liquids price list**” means a *price list* (if any) prepared and *published* by the *market service provider* under rule 4.2(a)(iii) or 4.2(b)(iii).

“**line losses**” are to be determined in accordance with the *operating procedures*.

Appendix 8

Note: See clause A5.7 of the *operating procedures*.

“**market service provider**” means the Western Power Corporation referred to in section 4 of the *Electricity Corporation Act 1994*.

“**maximum trading requirement**” means the maximum quantity of *trading top-up electricity* and *trading spill electricity* notified to the *market service provider* from time to time under rule 3.9.

“**member**” means a person joined as such under these rules and includes the *market service provider*.

“**membership notice**” means a notice under, as applicable, rule 2.8, 2.9(b) or 2.10.

“**negative assurance audit**” means a review with the objective of enabling the *auditor* to state whether, on the basis of review procedures that do not provide all the evidence that would be required in a standard audit, anything has come to the *auditor’s* attention that indicates the *market service provider’s* non-compliance with the rules set out in A2.1.

“**network**” has the meaning given to “electricity distribution system” and “electricity transmission system” in the *Electricity Corporation Act 1994*.

Note: At the time these rules commenced, the definitions in section 89 of the Act were:

“ ‘electricity distribution system’ means:

- (a) the part or parts of the system operated by the corporation for the transportation of electricity that is or are prescribed by the regulations for the purposes of this paragraph; and
- (b) plant and equipment that is –
 - (i) used by the corporation –
 - (I) in connection with the transfer of electricity to or from any part referred to in paragraph (a); or
 - (II) for a purpose related to such transfer;
 - and
 - (ii) prescribed, or of a kind that is prescribed, by the regulations for the purposes of this subparagraph.

‘electricity transmission system’ means:

- (a) the part or parts of the system operated by the corporation for the transportation of electricity that is or are prescribed by the regulations for the purposes of this paragraph; and

Appendix 8

- (b) plant and equipment that is –
- (i) used by the corporation –
 - (I) in connection with the transfer of electricity to or from any part referred to in paragraph (a); or
 - (II) for a purpose related to such transfer;
 - and
 - (ii) prescribed, or of a kind that is prescribed, by the regulations for the purposes of this subparagraph.”

“**nomination**” means a nomination for an amount of *trading top-up electricity* or *trading spill electricity* under rule 3.16 for a half hour in a *supply day*.

“**nomination day**” means the *business day* before the *supply day* (that is, the day on which *nominations* occur).

“**normal price list**” means a *price list* that applies except when a *high price list* or *liquids price list* is in effect.

“**operating procedures**” means the procedures set out in Appendix 5.

“**output**” is defined in rule 7.2.

“**payment default notice**” means a notice given in accordance with rule 6.2.

“**price list**” means a *trading price list* or a *balancing price list*.

“**pricing period**” means the period to which a set of *price lists* applies.

“**publish**” is defined in rule 9.3.

“**reasonable and prudent person**” means a person acting in good faith and in accordance with *good electricity industry practice*.

“**receipt date**” means the date on which a member receives an *imbalance default notice*.

“**residual imbalance**” is defined in rule 3.37.

“**residual imbalance tariff**” means the tariff specified in the *residual imbalance tariff list* as applying for the band in which the *residual imbalance* falls.

“**residual imbalance tariff list**” means a list *published* under rule 4.3.

“**revised nomination**” is defined in rule 3.19(c).

“**spill charge**” means the charge payable by the *market service provider* for a half hour, calculated by multiplying the applicable *spill price* by the *member’s* supply of *spill electricity* during the half hour.

“**spill price**” means a *trading spill price* or a *balancing spill price*.

“**spill electricity**” means either or both of *trading spill electricity* and *balancing spill electricity*.

“**supply day**” means the day to which a *nomination* or *accepted nomination* relates (that is, the day on which the *trading electricity* is provided).

“**SUR**” means (in kW) the rate at which the *member* is transferring *trading spill electricity* to the *market service provider* during the half hour.

“**SWIS**” means the “South West interconnected system” as defined in the *Electricity Industry Act 2004*.

“**technical code**” means a technical code made under:

- (a) regulation 26 of the *ETR*; or
- (b) regulation 28 of the *EDR*,

as amended or replaced from time to time.

“**top-up charge**” means the charge payable by a *member* for a half hour, calculated by multiplying the applicable *top-up price* to the *member’s* usage of *top-up electricity* during the half hour.

“**top-up electricity**” means either or both of *trading top-up electricity* and *balancing top-up electricity*.

“**top-up price**” means a *trading top-up price* or a *balancing top-up price*.

“**TCMD**” or “**total contract maximum demand**” means the sum across all *connection points* covered by an *access contract* of the *CMDs* for each *connection point*.

“**trading band**” means a band specified under rule 4.10.

“**trading price list**” means a list of prices prepared and *published* by the *market service provider* under rule 4.2(b) specifying prices for *trading electricity* and comprising under these rules either a *normal price list*, a *high price list*, or a *liquids price list*.

“**trading electricity**” is defined in rule 3.6(a) and means *trading top-up electricity* or *trading spill electricity*.

“**trading spill electricity**” means the electricity accepted by the *market service provider* from a *member* as defined in rule 3.6(a)(ii).

“**trading spill price**” means the applicable price for *trading spill electricity* determined under rule 4.5 from the prices specified in a *trading price list*.

“**trading top-up electricity**” means the electricity supplied by the *market service provider* to a *member* as defined in rule 3.6(a)(i).

“**trading top-up price**” means the applicable price for *trading top-up electricity* determined under rule 4.5 from the prices specified in a *trading price list*.

“**transfer point**” means a *connection point* between different *networks*.

“**TUAS consultation group**” means the group convened under rule 11.1.

“**TUAS charge**” means an amount payable under these rules.

“**TUAS market**” is defined in rule 3.6.

“**TUR**” means (in kW) the rate at which the *market service provider* is transferring *trading top-up electricity* to the *member* during the half hour.

Interpretation

1.2 The rules of interpretation in the *Interpretation Act 1984* apply to the interpretation of these rules.

1.3 In these rules, unless the contrary intention appears:

- (a) “**including**” and similar expressions are not words of limitation; and
- (b) where a word or expression is given a particular meaning, other parts of speech and grammatical forms of that word or expression have a corresponding meaning; and
- (c) where italic typeface has been applied to some words and expressions, it is solely to indicate that those words or phrases may be defined in rule 1.2 or elsewhere, and in interpreting these rules the fact that italic typeface has or has not been applied to a word or expression is to be disregarded (but nothing in this rule 1.4(c) limits the operation of rule 1.2); and
- (d) where information in these rules is set out in a box, whether or not preceded by the expression “Note”, “Outline” or “Example”, the information:
 - (i) is provided for information only and does not form part of these rules; and
 - (ii) is to be disregarded in interpreting these rules; and
 - (iii) might not reflect amendments to these rules or other documents or written laws;and
- (e) where a clause number commences with “A”, the clause appears in the Appendices to these rules.

References to a member include its generators and customers

1.4 A reference in these rules to a *member* transferring electricity into the *SWIS* includes the transferring of electricity into the *SWIS* by or on behalf of the *member* or any of its electricity suppliers (if it has any).

1.5 A reference in these rules to a *member* withdrawing electricity from the *SWIS* includes the withdrawal of electricity from the *SWIS* by or on behalf of the *member* or any of its electricity customers (if it has any).

Appendix 8: Chapter 2 – Membership

Market service provider is a member

2.1 The *market service provider* becomes a *member* on commencement of these rules.

Application for membership

2.2 A person (“**applicant**”) who wishes to become a *member* may give written notice requesting membership materially in the form set out in Appendix 1 (“**application**”) to the *market service provider*, addressed to “Network Access Services Manager”.

Member must have access contract

2.3 A *member* may not participate in the *TUAS market* on a day unless the *member* is entitled under an *access contract* to access the *SWIS* on the day.

Amendment of access contract to provide for cross-default in payment

2.4 An *applicant* may by notice to the *market service provider* offer to amend its *access contract* to include a provision to the effect that any *default of payment* under these rules by the *applicant* (after it has become a *member*) is to be treated in the *access contract* as though it was also a default in payment under the *access contract*.

2.5 If the *market service provider* gives an *applicant* a *membership notice*, it is deemed, if it has not already done so, to have accepted the offer under rule 2.4, and the *access contract* is amended accordingly.

Security from *applicant* if access contract not amended

2.6 If:

- (a) an *applicant* does not elect to amend its *access contract* under rule 2.4; and
- (b) the *market service provider* (acting as a *reasonable and prudent person*) determines that there is a material risk that, when the *applicant* becomes a *member*, it will be unable to meet its obligation to pay an amount due under these rules,

then the *market service provider* may require the *applicant*, at the *applicant's* election, to either:

- (c) pay a deposit equal to a reasonable estimate of the *applicant's* likely net obligations (after it becomes a *member*) to pay the *market service provider* under these rules over the coming 2 month period; or
- (d) provide a bank guarantee in terms acceptable to the *market service provider* (acting reasonably) guaranteeing the payment of the amount referred to in rule 2.6(c).

One membership per access contract

- 2.7 A person is entitled to membership of the *TUAS market* and the benefits of that membership once for each *access contract* to which the person is a party, regardless of:
- (a) how many generation units, and of what type, the person uses to generate electricity transferred under the *access contract*, and
 - (b) how many *connection points*, and of what type, are covered by the *access contract*.

Membership notice

- 2.8 If an *applicant* offers to amend its *access contract* under rule 2.4, then the *market service provider* must within 3 *business days* after receiving the *application* give written notice ("**membership notice**") to the *applicant* confirming its membership, and the *applicant* is joined as a *member* from the date of the *membership notice*.
- 2.9 If an *applicant* does not offer to amend its *access contract* under rule 2.4, then the *market service provider* must within 5 *business days* after receiving the *application* either:
- (a) notify the *applicant* that the *market service provider* requires security under rule 2.6 and the amount of the security required; or
 - (b) give written notice ("**membership notice**") to the *applicant* confirming its membership, and the *applicant* is joined as a *member* from the date of the *membership notice*.
- 2.10 If the *market service provider* gives notice under rule 2.9(a) that it will require security, and the *applicant* either pays a deposit under rule 2.6(c) or provides a bank guarantee under rule 2.6(d), then within 5 *business days* after receiving the payment or deposit the *market service provider* must give written notice ("**membership notice**") to the *applicant* confirming its membership, and the *applicant* is joined as a *member* from the date of the *membership notice*.
- 2.11 The time periods in rules 2.9 and 2.10 are suspended to the extent that the *market service provider* is prevented from complying with them due to the *applicant* failing to provide reasonably sufficient information to enable the *market service provider* to determine whether it requires security under rule 2.6 and if so the amount of the security required.

Application disputes

- 2.12 A dispute between the *market service provider* and an *applicant* may be referred to the *arbitrator*, who is to determine it as though it was a dispute between the *market service provider* and a *member* under these rules.

When the rules apply to a member (other than the *market service provider*)

- 2.13 These rules apply to govern the relationships between the *market service provider* and another *member* from the start of the next *balancing month* to start after:
- (a) if the other *member* has joined at or prior to the commencement of these rules — the commencement of these rules;
 - (b) if the other *member* joined after the commencement of these rules — the date the *member* joined.

Cancelling membership

- 2.14 A *member* (other than the *market service provider*) may cancel its membership by giving at least 3 months' written notice to the *market service provider*.
- 2.15 The *market service provider* may not cancel its membership.
- 2.16 The following rules will apply to a *former member* as though it was a *member*:
- (a) rules 1.2 to 1.6 and
 - (b) rule 2.16; and
 - (c) rules 3.3 to 3.5; and
 - (d) rule 6.14; and
 - (e) Chapter 8; and
 - (f) rules 9.1 and 9.2; and
 - (g) rules 9.4 to 9.6.

Security from member if access contract not amended

- 2.17 If:
- (a) a *member* did not, at the time of joining, elect to amend its *access contract* under rule 2.4; and
 - (b) the *market service provider* (acting as a *reasonable and prudent person*) determines at any time after the *member* joins that there is a material risk that the *member* will be unable to meet its obligation to pay for an amount due under these rules,

then the *market service provider* may require the *member*, at the *member's* election, to either pay a deposit under rule 2.6(c) or provide a bank guarantee under rule 2.6(d).

Parties may contract inconsistently with these rules

- 2.18 Nothing in these rules prevents *members* from entering into an agreement that deals with the subject matter of these rules in a way that differs from the treatment of those matters in these rules.

Appendix 8: Chapter 3 – TUAS market

Obligation to provide

- 3.1 The *member*:
- (a) may supply wholesale *balancing spill electricity* to the *market service provider*, and
 - (b) may accept wholesale *balancing top-up electricity* from the *market service provider*,
 - (c) may *nominate* to supply, and if so must supply, wholesale *trading spill electricity* to the *market service provider*, and
 - (d) may *nominate* to accept, and if so must accept, *wholesale trading top-up electricity* from the *market service provider*,

on the terms set out in these rules.

- 3.2 The *market service provider* must:
- (a) manage and operate the *TUAS market*, and
 - (b) supply wholesale *top-up electricity* to a *member*, and
 - (c) accept wholesale *spill electricity* from a *member*,

on the terms set out in these rules.

Payment obligation

- 3.3 The *member* must pay the *market service provider* the *top-up price* for any *top-up electricity* provided under these rules.
- 3.4 The *market service provider* must pay the *member* the *spill price* for any *spill electricity* provided under these rules.
- 3.5 An amount payable under these rules is recoverable as a contractual debt.

Trading electricity and balancing electricity

- 3.6 The “**TUAS market**”, for any half hour period, consists of either or both of:
- (a) “**trading electricity**” for which the *market service provider* and a *member* contract on a day-ahead basis, being either:

- (i) “**trading top-up electricity**” which is a specified quantity of wholesale electricity that the *market service provider* will supply to the *member*, and the *member* will accept; or
 - (ii) “**trading spill electricity**” which is a specified quantity of wholesale electricity that the *member* will supply to the *market service provider*, and the *market service provider* will accept;
- and
- (b) “**balancing electricity**”, being either:
 - (i) “**balancing top-up electricity**” which is the quantity of wholesale electricity required to offset a *member’s* negative *imbalance*, that the *market service provider* supplies to the *member*, and the *member* accepts;
 - or
 - (ii) “**balancing spill electricity**” which is the quantity of wholesale electricity required to offset a *member’s* positive *imbalance*, that the *member* supplies to the *market service provider*, and the *market service provider* accepts.

Exit point for spill electricity

- 3.7 For the purposes of an *access contract* and the access regulations, the exit point at which spill electricity is transferred out of the *SWIS* to the *market service provider* is deemed to be the connection for Muja power station.

Entry point for top-up electricity

- 3.8 For the purposes of an *access contract* and the *access regulations*, the *entry point* at which *top-up electricity* is transferred into the *SWIS* by the *market service provider* is deemed to be the connection for Muja power station.

Member’s maximum trading requirement

- 3.9 The maximum quantity of *trading top-up electricity* and *trading spill electricity* that the *member* may accept or supply for a half hour in a *supply day* is the amount notified to the *market service provider* by the *member* from time to time in accordance with rules 3.10 to 3.14 (“**maximum trading requirement**”).

Note: The <i>maximum trading requirement</i> is to be specified in terms of energy (kWh) for each of top up and spill, for each half hour period in a day.
--

- 3.10 The *member’s maximum trading requirement* for *trading top-up electricity* for a half hour must not exceed the sum of the *CMDs* of all the *member’s* loads at *exit points* covered by the *access contract* for the half hour.

Appendix 8

- 3.11 The *member's maximum trading requirement* for *trading spill electricity* for a half hour must not exceed the sum of the *DSOCs* of all the *member's* generating plant at *entry points* covered by the *access contract* for the half hour.
- 3.12 A *member* must notify the *market service provider* of its *maximum trading requirement* for a month at least 2 weeks before the *market service provider* is obliged to *publish a price list* under rule 5.10 for the month.
- 3.13 A *member* may comply with rule 3.12 by giving a standing notification.
- 3.14 Rule 3.12 does not apply in respect of the first 4 months after these rules commence.

Advance notice of likely unavailability

- 3.15 The *market service provider* must use reasonable endeavours, where reasonably practicable, by 9am on the *nomination day*, to give notice to members in respect of one or more half hour periods in a *supply day* if it considers that it is unlikely to be able to meet all *members' maximum trading requirements* as specified under rule 3.9 in the half hour.

Nomination of trading amounts

- 3.16 By 10am on the *nomination day*, a *member* may for one or more half hours in the *supply day* nominate to the *market service provider* the amount of *trading top-up electricity* it wishes to accept or *trading spill electricity* it wishes to supply in the half hour ("**nomination**").
- 3.17 By 12 noon on the *nomination day*, the *market service provider* must for each half hour in the *supply day* notify each *member* that made a *nomination* of:
- (a) the amount of the *nomination* which the *market service provider* proposes to accept, determined in accordance with:
 - (i) rule 3.21; and
 - (ii) any applicable *operating procedures*;and
 - (b) the *trading price list* that is to apply to the half hour unless a liquids event is declared.
- 3.18 If:
- (a) the *trading price list* notified under rule 3.17(b) is the same as the one which was in effect for the half hour when the *nomination* was submitted; and
 - (b) the *market service provider* proposes to accept the whole of the *member's nomination* ,
- then the *nomination* is the *member's* "**accepted nomination**" for the half hour.

Appendix 8

3.19 If:

- (a) the *trading price list* notified under rule 3.17(b) is not the same as the one which was in effect for the half hour when the *nomination* was submitted (for which purpose the *price list* in effect when the *nomination* was submitted is the *normal price list* unless the *market service provider* had previously designated the *supply day* as a *high price day* under rule 4.7 or the relevant part of the *supply day* as a *liquids event* under rule 4.8); or
- (b) the *market service provider* proposes not to accept the whole of the *member's nomination* ,

or both, then:

- (c) by 2pm on the *nomination day* the *member* may for each half hour in the *supply day*:
 - (i) withdraw its *nomination* ; or
 - (ii) submit a “**revised nomination**”; or
 - (iii) notify the *market service provider* that it will accept the amount notified by the *market service provider* under rule 3.17(a) under the price list notified by the *market service provider* under rule 3.17(b);

and

- (d) unless the *member* withdraws its *nomination* under rule 3.19(c)(i), the *member* and the *market service provider* must communicate and by 4pm on the *nomination day* must agree upon the “**accepted nomination**” and the price for the half hour, in accordance with:
 - (i) rule 3.21; and
 - (ii) any applicable *operating procedures*.
- (e) The *market service provider* may reject a *revised nomination* for a half hour if the *revised nomination* is for *trading top-up electricity* when the *member* originally *nominated* under rule 3.16 for *trading spill electricity* for the half hour, and vice versa.
- (f) If,
 - (i) the *market service provider* notifies a *member* of a change in price under rule 3.17(a) or a change in the *member's nomination* amount under rule 3.17(b); and
 - (ii) the *member* does not communicate with the *market service provider* regarding its *nomination* in accordance with rule 3.19(d),

then the *member's nomination* will lapse, and the *member* is deemed not to accept or supply any *trading electricity* on the *supply day*.

When *market service provider* may refuse to accept nomination

Appendix 8

- 3.20 The *market service provider* may (acting as a *reasonable and prudent person*) refuse to accept a *nomination* from a *member* in a month if:
- (a) the *member* fails to comply with the *nomination* procedure set out in these rules or in the *operating procedures* for that month; or
 - (b) it is permitted to do so under Chapter 6; or
 - (c) the *nomination* is for an amount greater than the *member's maximum trading requirement* notified under rule 3.9; or
 - (d) the *member* has failed to comply with rule 3.12 for that month.

Level of nominations which must be accepted

- 3.21 The *market service provider* must accept *nominations* for *trading electricity* for a half hour up to the level (across all *members*) above which, in the *market service provider's* view as a *reasonable and prudent person*, accepting a higher level of *nominations*:
- (a) could compromise the secure and reliable operation of the *SWIS*; or
 - (b) in the case of *trading top-up electricity* — might reasonably be expected to require liquids to be burnt in the half hour.
- 3.22 The *market service provider* (acting as a *reasonable and prudent person*) must:
- (a) aggregate *nominations* across *members* and across *trading electricity* for the purposes of rule 3.21 using a methodology which would be adopted by a *reasonable and prudent person*; and
 - (b) apportion *nominations* between *members* for a day, if not all *members' nominations* for *trading electricity* can be accepted for the day, on a pro-rata basis by reference to the *members' nominations* (but the *market service provider* may change the apportionment if it believes in good faith that a *member's nomination* was deliberately set at a level designed to influence the outcome of this apportionment).

Effect of an accepted nomination

- 3.23 An accepted *nomination* has effect as a contract between the *member* and the *market service provider* for the provision for the half hour of the amount of *trading electricity* specified in the accepted *nomination* at a price determined under rule 4.5.
- 3.24 The *TUAS charges* are payable whether or not the *market service provider* supplies the amount of *trading top-up electricity* or a *member* supplies the amount of *trading spill electricity* specified in the *accepted nomination* .

Forecast production data

- 3.25 For the purposes of rule 3.28, a *member* may provide non-binding “**forecast production data**” for each month:
- (a) if it is an *intermittent renewable generator*, or
 - (b) if it is both an *intermittent renewable generator* and a *dispatchable generator*, in which case it may do so in relation to its *intermittent renewable plant*.
- 3.26 *Forecast production data* for a month must be provided at least 2 weeks before the *market service provider* is obliged to *publish* a price list under rule 5.10(b).
- 3.27 Rule 3.26 does not apply in respect of the first 4 months after these rules commence.

Balancing band

- 3.28 The “**balancing band**” for a *member* for a half hour in a *supply day* is determined as follows:
- (a) for *balancing spill electricity*, the balancing band is the larger of:
 - (i) if the *member's* plant includes intermittent renewable plant (whether or not it also includes dispatchable plant) and the *member* has provided forecast production data in respect of the *supply day* — the sum of the DSOCs of the *member's* intermittent renewable plants for which the forecast production data has been provided under rule 3.25; and
 - (ii) the lesser of 10 MW and the sum (across all the *member's* dispatchable plant if any) of the *member's* DSOCs;and
 - (b) for *balancing top-up electricity*, the balancing band is the larger of:
 - (i) if the *member's* plant includes intermittent renewable plant (whether or not it also includes dispatchable plant) and the *member* has provided forecast production data in respect of the *supply day* — the lesser of the sum of the DSOCs of the *member's* intermittent renewable plants for which the forecast production data has been provided under rule 3.25 and the *member's* TCMD; and
 - (ii) the lesser of 10 MW and the *member's* TCMD.

Calculating member's imbalance

- 3.29 The *member's* “**imbalance**” for a half hour in a *supply day* is calculated as:
- (a) the sum of all the *member's* electricity generation (adjusted for *line losses*) in the half hour plus the amount of any *trading top-up electricity* in an *accepted nomination* for the half hour (adjusted for *line losses*),
- minus:

Appendix 8

- (b) the sum of all of the *member's* electricity loads (adjusted for *line losses*) in the half hour plus the amount of any *trading spill electricity* in an *accepted nomination* for the half hour (adjusted for *line losses*).

The market service provider must supply or accept balancing electricity

3.30 The *market service provider* must:

- (a) if the *imbalance* is a negative number — supply *balancing top-up electricity* up to the lesser of:
 - (i) the *member's imbalance*; and
 - (ii) the *member's* balancing band for top-up electricity calculated under rule 3.28(b);and
- (b) if the *imbalance* is a positive number — accept *balancing spill electricity* up to the lesser of :
 - (i) the *member's imbalance*; and
 - (ii) the *member's balancing band* for *spill electricity* calculated under rule 3.28(a).

Members must maintain adequate generation capacity

- 3.31 The *member* must ensure at all times that the sum of electricity (adjusted for *line losses*) which it is transferring out of the *SWIS* at any time at all *exit points* covered by the *access contract* is equal to or less than the sum of the *DSOC* of all its generating plant at *entry points* covered by the *access contract*.
- 3.32 If the member is an *intermittent renewable generator*, then it must ensure that the sum of electricity (adjusted for *line losses*) which it is transferring out of the *SWIS* at all *exit points* covered by the *access contract* calculated over a year is equal to or less than the sum of:
 - (a) 110% of the sum of the *output* from all its *intermittent renewable plant* at *entry points* covered by the *access contract* in the year; and
 - (b) if it also has *dispatchable plant* — the electricity production capability of its *dispatchable plant* (calculated as the *DSOC* of the *dispatchable plant* multiplied by the number of hours over the year).

These rules do not affect standby power and ancillary services arrangements

3.33 Nothing in these rules affects:

- (a) any obligation on a *member* to have arrangements in place in respect of standby power or ancillary services; or
- (b) the operation of any such arrangements.

Top up and spill calculated on an aggregated basis

- 3.34 Requirements for *trading electricity* and *balancing electricity* are calculated on an aggregated basis for each *access contract*, across all of the *member's entry points* and *exit points*.

Relief from obligation to provide trading electricity

- 3.35 To the extent that the *market service provider* as a *reasonable and prudent person* determines that continuing to supply *trading electricity* to a *member* or accept *trading electricity* from a *member* could compromise the secure and reliable operation of the *SWIS*, then:
- (a) the *market service provider* may refuse to supply or accept the *trading electricity*, and
 - (b) to the extent that the *market service provider* refuses under rule 3.35(a) to supply or accept *trading electricity*, then either:
 - (i) if the refusal is to supply *trading top-up electricity* — the *market service provider* must pay the *member* for each kWh of *trading electricity* not provided, at a rate per kWh equal to the prevailing “residual imbalance (top-up) fee” in Appendix 3 or Appendix 4 (as applicable); or
 - (ii) if the refusal is to supply *trading spill electricity* — the *member* must pay the *market service provider* for each kWh of *trading electricity* not accepted, at a rate per kWh equal to the prevailing “residual imbalance (spill) fee” in Appendix 3 or Appendix 4 (as applicable);and
 - (c) the *market service provider* must:
 - (i) communicate its refusal to provide or accept the *trading electricity* to the *member* as soon as possible; and
 - (ii) provide reasons for the curtailment to *members* within 48 hours of the curtailment taking effect; and
 - (iii) document the reasons for the curtailment in sufficient detail to allow for future audit of the decision in accordance with rule 5.17.

The TUAS market during a liquids event

- 3.36 Unless rule 3.35 applies, a liquids event has no effect on the *market service provider's* obligation to provide *trading electricity* up to the level of the *accepted nomination* or *balancing electricity*.

Calculating member's residual imbalance

- 3.37 A *member's* “**residual imbalance**” is determined as follows:

- (a) if the *imbalance* is a negative number, then:
- (i) if the absolute value of the *imbalance* is less than or equal to the *member's balancing band* for *top-up electricity* calculated under rule 3.28(b) — the *residual imbalance* is zero; and
 - (ii) otherwise — the *residual imbalance* is calculated as follows:

$$RI = (-1) \times \{ |I| - BB_{TU} \},$$

where:

RI is the *residual imbalance*; and

$|I|$ is the absolute value of the *imbalance*; and

BB_{TU} is the *member's balancing band* for *top-up electricity* calculated under rule 3.28(b);

and

- (b) if the *imbalance* is a positive number, then:
- (i) if the *imbalance* is less than or equal to the *member's balancing band* for *spill electricity* calculated under rule 3.28(a) — the *residual imbalance* is zero; and
 - (ii) otherwise — the *residual imbalance* is calculated as follows:

$$RI = I - BB_S,$$

where:

RI is the *residual imbalance*; and

I is the *imbalance*; and

BB_S is the *member's balancing band* for *spill electricity* calculated under rule 3.28(a).

ETR balancing provisions

- 3.38 In rule 3.39, “**excluded ETR provisions**” means regulations 21, 22, 23, 24 and 25 of the *ETR*.
- 3.39 To the extent that the *access contract* between the *member* and the *market service provider* relates to access to the “electricity transmission network” as defined in the *ETR*, then:
- (a) the excluded *ETR provisions* do not apply to, as terms of, or in respect of the *access contract*; and
 - (b) the provisions in Appendix 3 apply as terms of the *access contract* as though:

Appendix 8

- (i) they were set out in Part 4 of the *ETR* in place of the excluded *ETR provisions*; and
- (ii) they were specified in regulation 46 of the *ETR* as essential terms of the *access contract* for the purposes of clause 2(4) of Schedule 5 to the *Electricity Corporation Act 1994*; and
- (iii) they were expressly incorporated into the *access contract*.

3.40 Rule 3.39(a) applies whether or not the *access contract* would otherwise be read as expressly or impliedly incorporating the *excluded ETR provisions* either in full or by reference.

EDR balancing provisions

3.41 In rule 3.42, “**excluded EDR provisions**” means regulations 23, 24, 25, 26 and 27 of the *EDR*.

3.42 To the extent that the *access contract* between the *member* and the *market service provider* relates to access to the “electricity distribution network” as defined in the *EDR*, then:

- (a) the excluded *EDR provisions* do not apply to, as terms of, or in respect of the *access contract*; and
- (b) the provisions in Appendix 4 apply as terms of the *access contract* as though:
 - (i) they were set out in Part 4 of the *EDR* in place of the *excluded EDR provisions*; and
 - (ii) they were specified in regulation 47 of the *EDR* as essential terms of the *access contract* for the purposes of clause 2(4) of Schedule 6 to the *Electricity Corporation Act 1994*; and
 - (iii) they were expressly incorporated into the *access contract*.

3.43 Rule 3.42(a) applies whether or not the *access contract* would otherwise be read as expressly or impliedly incorporating the *excluded EDR provisions* either in full or by reference.

Appendix 8: Chapter 4 - Price lists

Price lists

4.1 For every half hour period in a *supply day*, there must at all times be *price lists* in effect which collectively specify:

- (a) a *trading top-up price* (for each *trading top-up band*); and
- (b) a *trading spill price* (for each *trading spill band*); and
- (c) a *balancing top-up price*; and

- (d) a *balancing spill price*.
- 4.2 The *market service provider* must prepare, and must *publish*, *price lists* which are consistent with rule 4.1 and rules 5.1 to 5.10 and are structured as follows:
- (a) for each of *balancing top-up electricity* and *balancing spill electricity*:
 - (i) there must be a *normal price list*; and
 - (ii) there may be one or more high *price lists*; and
 - (iii) there may be a *liquids price list*,
each of which is a “**balancing price list**”; and
 - (b) for each *trading band*, for each of *trading top-up electricity* and *trading spill electricity*:
 - (i) there must be a *normal price list*; and
 - (ii) there may be one or more high *price lists*; and
 - (iii) there may be a *liquids price list*,
each of which is a “**trading price list**”.

Residual imbalance tariff list

- 4.3 The *market service provider* must prepare, and must *publish*, a *residual imbalance tariff list* for *residual imbalance tariffs*, and the tariffs contained in that *residual imbalance tariff list* must be calculated in accordance with rule 5.7.
- 4.4 The *residual imbalance tariff list* may be expressed as one or more margins which apply above or below the prices in a *price list*.

Determining the price payable

- 4.5 The price payable for *trading electricity* for a half hour in a *supply day* is:
- (a) subject to rule 4.5(b), the price specified for the half hour in the *trading price list* notified for the *supply day* under rule 3.17(b); or
 - (b) if the *market service provider* and the *member* agree a different price under rule 3.19(d), the agreed price.
- 4.6 The price payable for *balancing electricity* for a half hour in a *supply day* is
- (a) subject to rules 4.6(b) and 4.6(c) — the price specified for the half hour in the relevant *normal price list* for the *balancing electricity*; or
 - (b) subject to rule 4.6(c), if the day has been designated a *high price day* — the price specified for the half hour in the relevant *high price list*; or
 - (c) if the half hour is within a period which has been designated as a *liquids event* and the *market service provider* has prepared and *published* a *liquids price*

Appendix 8

list for the type of *balancing electricity* concerned — the price specified for the half hour in the relevant *liquids price list*.

High price days

- 4.7 The *market service provider* may designate a *supply day* to be a *high price day*:
- (a) when the criteria specified in the *operating procedures* for doing so are met; and
 - (b) by notice given in accordance with the *operating procedures*; and
 - (c) at any time before, or at, the time specified in rule 3.17 on the *nomination day*.

Liquids events

- 4.8 The *market service provider* may designate a period of time (which may be all or part of the day) to be a *liquids event*:
- (a) when the criteria specified in the *operating procedures* for doing so are met; and
 - (b) by notice given in accordance with the *operating procedures*; and
 - (c) at any time prior to 30 minutes before the start of the period.
- 4.9 The *market service provider* must not designate more than one *liquids event* per *supply day*.

Trading bands

- 4.10 A “**trading band**” is a band for *trading electricity*, the boundaries of which are to be determined for each *member* in accordance with the *operating procedures*.

The *market service provider* may offer higher spill prices

- 4.11 The *market service provider* may from time to time, at its discretion, by notice to the *member*:
- (a) offer higher *trading spill prices* than those set out in the prevailing *price lists*; and
 - (b) if so, set a limit on how much *trading spill electricity* it is willing to accept at the higher prices.

Replacement of price lists in changed circumstances

- 4.12 If, during a period for which a *price list published* under rule 5.8 or rule 5.10 applies, an event occurs:

Appendix 8

- (a) which is beyond the *market service provider's* control, and which the *market service provider* acting as a *reasonable and prudent person* is not able to prevent or overcome; and
- (b) which results in a substantial change in the *market service provider's* costs of electricity generation from the level of those costs used when calculating the prices in the *price list*,

then the *market service provider* must:

- (c) prepare and *publish* proposed *replacement price lists*; and
- (d) provide a copy of each proposed *replacement price list* to the Minister, together with all reasonable supporting information required by the Minister.

4.13 The Minister has the function of auditing (to a standard and in accordance with procedures determined by the Minister in his or her discretion) the *replacement price lists* proposed under rule 4.12 to confirm that the circumstances justify their use and the prices in them.

4.14 Unless the Minister determines as a result of an audit under rule 4.13 that the circumstances do not justify the use of the *replacement price lists* proposed under rule 4.12 or the prices in them, the *replacement price lists* take effect 5 *business days* after they are provided to the Minister under rule 4.12(d).

Appendix 8: Chapter 5 - Pricing principles and review

Prices to be economically cost neutral

- 5.1 Subject to rule 5.4, the prices in *price lists* must be determined with a view to achieving the objective that the *market service provider's* provision of *balancing electricity* and *trading electricity* is "**economically cost neutral**".
- 5.2 *Economic cost neutrality* will be achieved if the *market service provider* is materially neither economically advantaged nor disadvantaged by providing all the *balancing electricity* and *trading electricity* collectively over the period to which the *price lists* apply.
- 5.3 *Economic cost neutrality* is to be assessed having regard to the forecast short run marginal cost of providing the *balancing electricity* and *trading electricity*, taking into account:
 - (a) the impact of seasons, daily load profile and variations between *business days* and non-business days; and
 - (b) the operating cost of plant dispatched by the *market service provider* to provide the *balancing electricity* and *trading electricity*, including allowances for scheduled maintenance of plant; and

- (c) the anticipated impact of the *balancing electricity* and *trading electricity* usage on the cost of providing the *balancing electricity* and *trading electricity*, including impacts on operating costs, fuel purchases and fuel storage costs; and
- (d) excluding any allowance for the cost of capital of generating plant used to provide the *balancing electricity* and *trading electricity*; and
- (e) the cost of administration of these rules; and
- (f) the administration fees payable by *members*; and
- (g) all *price lists* that will be in effect during the *pricing period*, and the likely amount of time that each *price list* will be applying.

Top-up trading prices may include 3% margin

- 5.4 The *top-up prices* in a *trading price list* may be 3% higher than would be required to achieve *economic cost neutrality*.

Trading prices may differ from balancing prices

- 5.5 The *price lists* for *trading electricity* may diverge from the *price lists* for the *balancing electricity* to account for the anticipated impact of usage of *balancing electricity* and *trading electricity* on the cost of providing the *balancing electricity* and *trading electricity*.

Balancing top-up price not to exceed balancing spill price

- 5.6 For any half hour period in the *balancing band* the *top-up price* must be equal to or less than the *spill price*.

Residual imbalance tariffs

- 5.7 The tariffs in the *residual imbalance* tariff list:
- (a) may diverge from the principle of economic cost neutrality set out in rule 5.2 and rule 5.3, but only to the extent necessary to provide an incentive for a *member* to endeavour to maintain its *residual imbalance* at zero; and
 - (b) must not be punitive.

Pricing period and pricing review

- 5.8 The initial *price lists* to apply from the commencement of these rules must be *published* immediately after these rules commence.
- 5.9 Subsequent *price lists* must:

Appendix 8

- (a) specify prices for *balancing electricity* and *trading electricity* and charges for *residual imbalance* covering at least a 1 month period beginning the day after the previous *price list* expires; and
- (b) be *published* by the *market service provider* at least 2 months before the *price list* is to take effect.

Administration Fee

- 5.10 The *market service provider* may charge an “**administration fee**” to *members* in connection with the provision of *balancing electricity* and *trading electricity*.
- 5.11 The *administration fee* must be determined with a view to achieving the objectives of *economic cost neutrality* under rules 5.1 to 5.3, subject to the following additional objectives:
- (a) recovering the reasonable costs referred to in rule 5.13 over the reasonably anticipated life of the *TUAS market* and its successors, from all reasonably anticipated users; and
 - (b) not imposing an inappropriate barrier to entry for initial *members*.
- 5.12 The *administration fee* will be sufficient to cover the costs directly connected with:
- (a) the further development of the pricing model; and
 - (b) calculating prices; and
 - (c) setting up the *TUAS market*; and
 - (d) communications with *members*; and
 - (e) managing the *TUAS market*; and
 - (f) any audit under these rules; and
 - (g) settlement.
- 5.13 Before imposing or changing an *administration fee*:
- (a) the *market service provider* must give the Minister notice of the proposed *administration fee*, together with all reasonable supporting information required by the Minister; and
 - (b) the Minister has the function of auditing (to a standard and in accordance with procedures determined by the Minister in his or her discretion) the *administration fee* to confirm that it complies with rules 5.12 and 5.13; and
 - (c) unless the Minister determines as a result of the audit that the *administration fee* does not comply with rules 5.12 and 5.13, the *administration fee* takes effect 5 *business days* after the notice was provided to the Minister under rule 5.14(a).
- 5.14 The *administration fee* is payable quarterly and in arrears.

Appendix 8

- 5.15 If the *member* has paid the *administration fee* for a quarter, it is exempted from paying any fee for administration charged by the *market service provider* under the *access regulations* for the quarter in respect of supply of *balancing electricity*.

Audit procedures

- 5.16 In accordance with Appendix 2, the *market service provider* must appoint an *auditor* to undertake an audit of:
- (a) the *price lists*; and
 - (b) the *administration fee*; and
 - (c) the *market service provider's* designation of *high price days*; and
 - (d) the *market service provider's* designation of *liquid events*; and
 - (e) curtailments of *trading electricity* enforced under rule 3.35; and
 - (f) curtailments of *trading electricity* enforced under rule 3.21.
- 5.17 To avoid doubt, the *residual imbalance tariffs* contained in the *residual imbalance tariff list* published by the *market service provider* under rule 4.3 will not be audited under rule 5.16.
- 5.18 The Minister may direct the *auditor* appointed under rule 5.16 to take into account, when performing his or her functions under Appendix 2, any matters referred to the Minister by *members* under rule 6.14.

Appendix 8: Chapter 6 - Compliance

Default

- 6.1 A *member* is in default if:
- (a) the *member* defaults in the due and punctual payment, at the time and in the manner required for payment by these rules, of any amount payable under these rules (“**default of payment**”); or
 - (b) the *member* defaults in the due and punctual performance or observance of any of its obligations contained or implied by operation of law in these rules; or
 - (c) an insolvency event occurs in respect of the *member*; or
 - (d) the *member* materially breaches any representation or warranty given to the other *member* under these rules.

Payment default

- 6.2 The *market service provider* may give a “**payment default notice**” to a *member* (other than the *market service provider*) when the *member* is in *default of payment*.

Appendix 8

- 6.3 The *market service provider* must withdraw a *payment default notice* as soon as the circumstances for the issue of a *payment default notice* cease to apply.

Effect of payment default notice

- 6.4 The *market service provider* may refuse to:
- (a) supply *balancing top-up electricity* to; and
 - (b) accept *balancing spill electricity* from,
- a *member* while the *member* is in receipt of a *payment default notice*.
- 6.5 To the extent that a *member* has been given a *payment default notice* and has an *imbalance* then the *imbalance* is to be dealt with as a *residual imbalance* under Appendix 3 or Appendix 4 as applicable.

General default

- 6.6 The *market service provider* may give a “**general default notice**” to a *member* (other than the *market service provider*) when the *member* is in *default*.
- 6.7 The *market service provider* must withdraw a *general default notice* as soon as the circumstances for the issue of a *general default notice* cease to apply.

Effect of general default notice

- 6.8 The *market service provider* may refuse to:
- (a) supply *trading top-up electricity* to; and
 - (b) accept *trading spill electricity* from,
- a *member* while the *member* is in receipt of a *payment default notice* or a *general default notice*.

Written warning for having a residual imbalance

- 6.9 If a *member* has a *residual imbalance* of an amount other than zero then the *market service provider* may issue a written warning advising the *member* of its failure to comply.
- 6.10 A warning under rule 6.9 may be issued as soon as practicable after settlement of the *balancing month* during which the *residual imbalance* occurred, or at any earlier time.

Imbalance default

- 6.11 The *market service provider* may as soon as practicable after settlement of the *balancing month*, or at any earlier time in respect of a *balancing month*, give an “**imbalance default notice**” to a *member* (other than the *market service provider*) if:

- (i) the *member* has a *residual imbalance* of an amount other than zero for at least one half hour in the *balancing month*; and
- (ii) the *market service provider* acting as a *reasonable and prudent person* determines that on at least one occasion in the *balancing month* the cause of the *member* having a *residual imbalance* of an amount other than zero was the *member's* failure to use reasonable endeavours to ensure that its *residual imbalance* for the half hour is zero.

Effect of imbalance default notice

6.12 The *market service provider* may refuse to:

- (a) supply *trading top-up electricity* to; and
- (b) accept *trading spill electricity* from,

a *member* from the date of receipt by the *member* of an *imbalance default notice* (“**receipt date**”) until the expiry of the period specified in rule 6.13 (“**expiry date**”).

6.13 The *expiry date* for the purposes of 6.12 is:

- (a) 7 days from the *receipt date*, if the *imbalance default notice* is the first *imbalance default notice* received in any 12 month period; or
- (b) up to 14 days from the *receipt date*, if the *imbalance default notice* is the second *imbalance default notice* received in any 12 month period; or
- (c) up to 21 days from the *receipt date*, if the *imbalance default notice* is the third *imbalance default notice* received in any 12 month period; or
- (d) up to the total number of days remaining in a *balancing month*, if the *imbalance default notice* is the fourth or further *imbalance default notice* received in any 12 month period.

Default by the *market service provider*

6.14 A *member* may refer to the Minister any failure or suspected failure by the *market service provider* to comply with these rules.

No termination for member's default

6.15 A *member's membership* is not to be terminated for *default* by the *member*.

6.16 Nothing in rule 6.15 limits any other remedies that may be available to another *member* as a result of the *default*.

Note: The parties may agree, or the arbitrator may determine when determining an access dispute, to include in an *access contract* a provision creating consequences in an *access contract* when a party is in breach under these rules.

Appendix 8: Chapter 7 - Intermittent renewable energy generators

Intermittent renewable generators defined

- 7.1 In these rules, “**intermittent renewable generator**” means a generator that has no or limited ability to control the availability of the renewable energy source used to generate electricity and which has no or very limited capacity to store energy.

Examples of *intermittent renewable generators* include wind farms, solar thermal (without storage) and run-of-river hydro generators.

Output for intermittent renewable generators

- 7.2 For the purposes of rule 3.32(a), the “**output**” of an *intermittent renewable generator* for a particular 12 month period is the energy in kWh produced by the generator in the period.

Appendix 8: Chapter 8 - Dispute resolution

Applicant

- 8.1 For the purpose of this Chapter 8 “**applicant**” means the *market service provider* or a *member* who has given notice of dispute under rule 8.3.

Disputes

- 8.2 The *members* must attempt to resolve any disputes arising out of or in connection with these rules in good faith by way of discussions between their respective authorised senior officers.

- 8.3 If the disputes are not resolved after 10 *business days* after discussions under rule 8.2 commence, either party may give written notice to:

- (a) the *arbitrator*; and
- (b) the other party,

and the dispute is by that notice referred to arbitration to be heard by the *arbitrator*.

- 8.4 An *applicant* may withdraw notification of the dispute at any time by notice to the *arbitrator* and all other parties to the dispute.

- 8.5 The *arbitrator*:

- (a) is not obliged to conduct an arbitration; and
- (b) may terminate an arbitration,

if, in the *arbitrator’s* opinion:

Appendix 8

- (c) the subject matter of the dispute is trivial, misconceived or lacking in substance; or
- (d) the notification of the dispute was vexatious; or
- (e) the *applicant* has not complied with rule 8.2 or has resorted to arbitration prematurely or unreasonably; or
- (f) the *arbitrator* is otherwise satisfied, on the application of a party to the dispute, that there are good reasons why the dispute should not be arbitrated.

Procedure

8.6 Appendix 6 applies.

Award by the arbitrator

8.7 Unless the *arbitrator* makes a decision under 8.5, the *arbitrator* must make a written award concerning the dispute.

8.8 The award referred to in rule 8.7:

- (a) must deal with the matter that was the basis for the notification of the dispute; and
- (b) may deal with any other matter that the *arbitrator* considers expedient to justly dispose of any proceedings before it.

8.9 Before making an award, the *arbitrator* must give a draft award to the parties to the arbitration and may take into account representations that any of them may make on the proposed award.

8.10 When the *arbitrator* makes an award, the *arbitrator* must give the parties to the arbitration written reasons for making the award.

Restrictions on awards

8.11 The *arbitrator* must not make an award that:

- (a) prejudices the rights of a *member* under these rules unless that *member* agrees or the *arbitrator* is satisfied that the *member* is or will be compensated on just terms for any loss suffered as a result; or
- (b) threatens the financial viability of the *market service provider*.

Effect of awards

8.12 Subject to rule 8.13, an award is binding on the parties to the arbitration in which it is made, from the date specified by the *arbitrator*.

Appendix 8

- 8.13 An *applicant* may, within 2 *business days* after an award is made which orders the *market service provider* to grant membership to the *applicant*, elect not to become a *member* as specified by the award by giving written notice of the election to the *arbitrator* and the *market service provider*.

No third party intervention in arbitration

- 8.14 Nothing in Chapter 8 gives any person other than the *market service provider* and the *applicant* a right to be heard before the *arbitrator*.

Performance of obligations

- 8.15 The *parties* must continue to perform their obligations under these rules despite the existence of a dispute, unless they agree otherwise or the *arbitrator* orders otherwise.

Commercial Arbitration Act 1985 does not apply

- 8.16 The dispute resolution processes provided for by these rules are not arbitrations within the meaning of the *Commercial Arbitration Act 1985*.

Additional jurisdiction of arbitrator for contractual disputes

- 8.17 The *arbitrator* has jurisdiction to hear a contractual dispute between the *market service provider* and a *member* if:
- (a) the agreement is one made under rule 2.18; and
 - (b) the dispute is referred to the *arbitrator* under the agreement.

Procedural rules for contractual disputes

- 8.18 Except to the extent that an agreement made under rule 2.18 provides otherwise, Appendix 6 applies with the appropriate modifications to the *arbitrator's* hearing of a contractual dispute.

Appendix 8: Chapter 9 - Other provisions

Provisions of access contract apply

- 9.1 Except where these rules provide otherwise, the provisions of the *access contract* apply to govern the relationship between the *market service provider* and another *member*.
- 9.2 Without limiting the generality of rule 9.1 and except where these rules provide otherwise, the following provisions of the *access contract* (if any) apply between the *member* and the *market service provider* in respect of the supply and acceptance of *balancing electricity* and *trading electricity*:
- (a) invoicing and payment; and

Appendix 8

- (b) representations and warranties; and
- (c) liability and indemnity; and
- (d) force majeure; and
- (e) notices.

Publishing information

9.3 Where a person is required to “**publish**” a thing under these rules, it must place details of the thing on a suitable website where it can be accessed by the relevant parties.

Title to electricity

9.4 Title to, and risk in, electricity which is transferred into a network at a *connection point* under these rules passes from a *member* other than the *market service provider* to the *market service provider* at the time it passes through the *connection point*.

9.5 Title to, and risk in, electricity which is transferred out of a network at a *connection point* under these rules passes from the *market service provider* to a *member* other than the *market service provider* at the time it passes through the *connection point*.

9.6 To avoid any doubt, by executing or complying with its obligations under these rules, a *member* other than the *market service provider* does not acquire any right, title or interest in or to the *network*.

Appendix 8: Chapter 10 - Operating procedures

Members must comply with operating procedures

10.1 Each *member* including the *market service provider* must comply with the *operating procedures* contained in Appendix 5.

Appendix 8: Chapter 11– TUAS Consultation Group

11.1 The Minister may from time to time convene a “**TUAS consultation group**” comprising:

- (a) an *appointee* representing the Coordinator of Energy;
- (b) 2 *appointees* representing the *market service provider*; and
- (c) 2 *appointees* representing the interests of *members* and potential *members*.

11.2 The Minister may from time to time appoint, and may from time to time remove and replace, one *appointee* as Chairperson of the *TUAS consultation group*.

Appendix 8

- 11.3 The Minister may appoint each *appointee* for a period of up to 2 years (but this does not limit clause 11.5 or the Minister's powers under rules 11.6(b)).
- 11.4 The Minister may re-appoint an *appointee* whose term of appointment has expired.
- 11.5 A person immediately ceases to be an *appointee* if the person:
- (a) becomes of unsound mind or a person liable, or a person whose assets are liable, to any control or administration under any law relating to physical or mental health; or
 - (b) resigns by notice to the Minister; or
 - (c) dies; or
 - (d) ceases to be a representative of the Coordinator of Energy, the *market service provider*, or a *member* or potential *member* (as the case may be).
- 11.6 The Minister:
- (a) is to determine appointments (in accordance with rule 11.1) to, and may determine the constitution and procedures of, the *TUAS consultation group*; and
 - (b) may discharge, alter or reconstitute the *TUAS consultation group*.
- 11.7 Subject to rule 11.6, the *TUAS consultation group* may determine its own procedures.

Appendix 8: Chapter 12 – Amendment of rules

Transitional amendments

- 12.1 The Minister may, within a 2 month period after the commencement of these rules, forego or abbreviate any consultation phase of these amendment procedures in respect of a proposed amendment to these rules.

Submission of request for amendment of the rules

- 12.2 Any person with a legitimate interest in requesting an amendment to these rules may make a written submission to the Minister specifying the proposed amendment and demonstrating why the amendment is necessary or desirable.

Amendment of TUAS market rules

- 12.3 The Minister may within 7 days either:
- (a) determine that the proposed amendment is vexatious, frivolous or not made in good faith, in which case he or she must notify the person who made the submission and the *market service provider* of the decision; or
 - (b) refer the proposed amendment to the *TUAS consultation group*.

Appendix 8

- 12.4 The *TUAS consultation group* may within 10 *business days* after the day on which the submission was provided to it:
- (a) determine whether the proposed amendment is likely to have a low impact on the *members* or the *market service provider*, and
 - (b) notify the Minister of any determination under 12.4(a).
- 12.5 Without limiting the *TUAS consultation group's* discretion under rule 12.4:
- (a) a proposed amendment has a low impact if it:
 - (i) corrects a typographical error; or
 - (ii) does not have a material impact on the information technology systems of the *market service provider* or other *members*; or
 - (iii) does not have a material impact on the *market service provider* or other *members*; and
 - (b) a proposed amendment is determined to have a high impact if it is not determined to have a low impact.
- 12.6 The *TUAS consultation group*, within 10 *business days* after the day on which the submission was provided to it, must make a recommendation to the Minister stating:
- (a) whether he or she should proceed with the proposed amendment; and
 - (b) if so the form the amendment should take.
- 12.7 The Minister must consult with *interested persons* before making a decision under rule 12.8 if:
- (a) the *TUAS consultation group* determines that the proposed amendment is likely to have a high impact on the *members* or the *market service provider*, or
 - (b) the *TUAS consultation group* does not make a determination under rule 12.4.
- 12.8 The Minister may consider any recommendation made by the *TUAS consultation group* and make a decision whether the proposed amendment be:
- (a) approved; or
 - (b) not approved, in which case the Minister may state details of the revisions required before the Minister may approve the proposed amendment.
- 12.9 As soon as practicable after making his or her decision, the Minister may notify the interested persons and the *TUAS consultation group* of his or her final decision and his or her reasons for the decision and the amendments to these rules take effect from the date specified by the Minister in his or her decision.
- 12.10 The Minister may produce an amended copy of these rules and make a public announcement that *interested persons* may obtain a copy of the amended rules from

Appendix 8

the Minister, as soon as reasonably practicable after a decision to make an amendment under rule 12.8 is made.

12.11 If the proposed amendment relates to Appendix 5, then the Minister must have regard to rule 12.13 when making a decision under rule 12.8.

12.12 The Minister may repeal these rules without complying with the amendment procedure specified in this Chapter 12.

Requirements for operating procedures

12.13 The *operating procedures* must:

- (a) be consistent with these rules; and
- (b) be fair; and
- (c) be reasonable; and
- (d) be consistent with *good electricity industry practice*; and
- (e) so far as reasonably practicable produce predictable and consistent outcomes, and not be susceptible to gaming by either the *market service provider* or another *member*; and
- (f) be sufficiently detailed and clear to enable a *member* or a prospective *member* to adequately determine its rights and obligations.

Appendix 8: Appendix 1 – Application form

See rule 2.2.

This is an *application* under rule 2.2 of the Top-up and Spill Market Rules for the *applicant* to join the *TUAS market*.

Date

A1.1 Date of this application:

Applicant

Provide details of the company which is to become the “member”.

A1.2 Name (“**applicant**”)

A1.3 ACN or ABN

A1.4 Address
.....

Contact person

Provide details of the person who is to act as the liaison between the applicant and Western Power in respect of the application.

A1.5 Name:

A1.6 Position:

A1.7 Phone:

A1.8 Fax:

A1.9 email:

Access contract

Provide details of the access contract to which this application relates.

A1.10 Date, and any other identifying details, of the access contract:
.....
.....
.....

Appendix 8

Modification of access contract

A1.11 (tick if applicable) The *applicant* offers to amend its *access contract* under rule 2.4

Information regarding security

A1.12 If the *applicant* has not ticked the box in clause A1.11, then the *applicant* must provide with this application financial and technical information which is reasonably sufficient to enable the *market service provider* to determine whether to require security under rule 2.6, and if so in respect of what amount.

Maximum trading requirements

A1.13 The *applicant's maximum trading requirement* under rule 3.9:

- (a) for *trading top-up electricity* is: kWh; and
- (b) for *trading spill electricity* is: kWh.

Note: The *maximum trading requirement* is to be specified in terms of energy (kWh) for each of top up and spill, for each half hour period in a day.

Forecast production data

A1.14 The *applicant* may provide with this application any forecast production data which it elects to provide under rule 3.25.

Signing

Signed on behalf of the applicant:

By:

Name and position:

Date:

Appendix 8: Appendix 2 – TUAS Audits

See rule 5.16.

Audit of the *market service provider*

A2.1 On or before 24 December 2004, and at 12 monthly intervals thereafter, the *market service provider* must appoint an *auditor*, in accordance with clause A2.3, to undertake a *negative assurance audit* of the *market service provider's* compliance during the year with the provisions listed in rule 5.16.

A2.2 The market service provider must:

- (a) ensure that the *negative assurance audit* is conducted in accordance with this Appendix 2; and
- (b) obtain the *auditor's* final report of its findings within 2 months after the end of the period to which the *negative assurance audit* relates.

Auditor's qualifications etc

A2.3 An *auditor* appointed under this Appendix 2 must have sufficient qualifications, resources, professional skill and experience to enable it to undertake the audit for which it is appointed.

Auditor's conflict of interest

A2.4 In this clause A2.4, but subject to clause A2.7, the term "**conflict of interest**" includes, but is not limited to:

- (a) the holding of any office; or
- (b) the entering into, or giving effect to, any contract, arrangement, understanding or relationship,

by an *auditor* or any of its directors, officers, servants or agents whereby, directly or indirectly, duties or interests are or might be created for the *auditor* or any of the *auditor's* directors, officers, servants or agents which conflict, or might reasonably be expected to conflict, with any one or more of:

- (i) the *auditor's* duties in conducting an audit under this Appendix 2; or
- (ii) the interests of the *market service provider*; or
- (iii) the interests of a *member*.

A2.5 The *market service provider* must ensure that the *auditor*:

- (a) before commencing any audit, and in any audit report, provides full disclosure of all actual or potential *conflicts of interest*,

Appendix 8

- (b) at all times has in operation effective procedures to detect any actual or potential *conflict of interest* which arises during the course of the audit; and
- (c) forthwith notifies the *market service provider* and *members* of any actual or potential conflict of interest which arises during the course of the audit, and of any non-compliance with this clause A2.5.

A2.6 The *market service provider* must not appoint an *auditor*, or having appointed an *auditor* must terminate the appointment, if the *market service provider* becomes aware of an actual or potential *conflict of interest* in the *auditor* which might reasonably be expected to materially adversely affect the *auditor's* independence and impartiality or the performance of its duties.

Note: Examples of when an actual or potential *conflict of interest* in an *auditor* might reasonably be expected to materially adversely affect the *auditor's* independence and impartiality or the performance of its duties, would be if the *auditor* is the person who designed the relevant systems.

A2.7 An *auditor* appointed to conduct an audit under this Appendix 2 is not to be taken to have a conflict of interest merely because it has previously been appointed to conduct an audit under this Appendix 2, or because it carries out other audit duties for a *member*.

Terms of auditor's retainer

A2.8 Except as stated in clauses A2.9 and A2.10, the terms of retainer of an *auditor* appointed under this Appendix 2 (including regarding remuneration, expenses, insurances and liability) are to be agreed between the *auditor* and the *market service provider*.

Confidentiality

A2.9 The *market service provider* must ensure that the *auditor* enters into a deed of undertaking regarding confidentiality on terms determined by the *market service provider* (acting reasonably), but that deed remains subject to clause A2.10.

A2.10 To the extent that disclosure by an *auditor* of any information or matter regarding a material non-compliance by the *market service provider* is necessary for the *auditor* to report on the material non-compliance, the *market service provider* must:

- (a) waive all of its rights to require that the *auditor* keep the information or matter confidential; and
- (b) authorise disclosure by the *auditor* of the information or matter in accordance with this Appendix 2.

The *market service provider*, members must cooperate with auditor

A2.11 The *market service provider* and other *members* must cooperate with and provide all reasonable assistance to an *auditor* appointed under this Appendix 2.

A2.12 Without limiting clause A2.11, the *market service provider* must comply without delay with any request by the *auditor* for the purpose of conducting an audit under this Appendix 2 for the *market service provider*:

- (a) to deliver to the *auditor* specified documents or records; and
- (b) to permit the *auditor*:
 - (i) to access its premises during a *business day*; and
 - (ii) to take copies of its records.

A2.13 As a pre-condition to cooperating and providing assistance under clause A2.12(b)(ii), a person may request to be identified as a covenantee under a deed executed under clause A2.9.

Audit report

A2.14 The *market service provider* must ensure that the *auditor's* report of a *negative assurance audit* under this Appendix 2 at least:

- (a) provides reasonable detail regarding the *auditor's* investigations and methodology; and
- (b) details any material restrictions or deficiencies in the *auditor's* access to or use of relevant documents or records; and
- (c) without limiting clause A2.14(a), details the circumstances of any non-compliance by the *market service provider* or the *member* with clauses A2.11 to A2.13, in respect of the *negative assurance audit*; and
- (d) complies with the deed of undertaking under clause A2.9; and
- (e) makes all disclosures required under clause A2.5; and
- (f) either:
 - (i) states that the *negative assurance audit* did not disclose non-compliance; or
 - (ii) provides details of each breach, non-compliance or other circumstance which prevents a statement under clause A2.14 being made.

Appendix 8

Level of Audit

- A2.15 In clauses A2.15 to A2.18, “**level**” means the degree of rigour with which a *negative assurance audit* is undertaken, including the size and nature of any sample used and the extent, if any, to which the sample is representative.
- A2.16 The *market service provider* and the appointed *auditor* are to agree the level of the *negative assurance audit*.
- A2.17 The *market service provider* must ensure that the intensity of the *negative assurance audit* is adequate and reasonable having regard to:
- (a) the requirements set out in this Appendix 2; and
 - (b) the need for the level to be sufficient for the *auditor* as a *reasonable and prudent person* to state that the *negative assurance audit* did not disclose non-compliance; and
 - (c) the objective that a *negative assurance audit* is normally designed to verify that systems and processes are functioning correctly.
- A2.18 A *member* may challenge the adequacy or level of a *negative assurance audit* conducted under this Appendix 2 by referring a matter to the Minister.

Audit report

- A2.19 For each audit period, the *auditor* must produce an audit report and provide a copy of the unedited audit report, within 2 months after the end of the relevant audit period, to:
- (a) the *market service provider*, and
 - (b) the Minister.

Audit summary report

- A2.20 For each audit period, the *auditor* must produce a summary audit report, after consulting with the *market service provider* regarding the content of the report, within 2 weeks after the end of the relevant audit period which:
- (a) details all significant instances of non-compliance identified in the *auditor’s* report produced under this Appendix 2; and
 - (b) details any action that has been taken or is proposed in respect of each instance of non-compliance identified in the audit report.
- A2.21 The *auditor* must provide a copy of the summary audit report, within 5 *business days* of its completion, to the Minister.
- A2.22 A *member* may request a copy of the summary audit report and the Minister may provide a copy to the *member* within 10 *business days* from the date of the request.

Appendix 8

A2.23 The *auditor's* report under clause A2.20 must as far as practicable be consistent with making adequate disclosure, not disclose details of matters expressly identified to it by the *market service provider* during the audit period as comprising the *market service provider's* intellectual property, marketing systems, information technology or otherwise being confidential or commercially sensitive information.

A2.24 Without limiting the *market service provider's* obligations under clause A2.1, the *Minister* may request the *market service provider* to appoint an *auditor*, in accordance with clause A2.3, to undertake an interim *negative assurance audit* of:

- (a) the *market service provider's* compliance since the last *negative assurance audit* with those provisions listed in rule 5.16 as specified by the *TUAS consultation group*; and
- (b) any other matters recommended to the *Minister* by the *TUAS consultation group* for the *auditor's* attention.

Subject to this clause, an interim *negative assurance audit* will be conducted in the same manner as a *negative assurance audit* conducted under clause A2.1.

Appendix 8: Appendix 3 - Modified ETR balancing provisions

See rule 3.39.

The provisions referred to in rule 3.39 are as follows:

“21. Interpretation of regulations 22, 23 and 25

In this regulation and regulations 22, 23 and 25 —

- (a) the “**group of connections**” in respect of a user’s access agreement consists of the entry points and exit points specified in the access agreement and the entry points from which standby power is being supplied to one or more of those connections;
- (b) if the market service provider is providing standby power under an arrangement with a user, then that standby power is to be taken to have been supplied at the connection for Muja power station; and
- (c) rules 3.7 and 3.8 apply in respect of spill electricity and top-up electricity respectively.

22. Balancing

- (1) A user must use reasonable endeavours to ensure that its residual imbalance for a half hour is zero.
- (3) The half hourly residual imbalance charge in respect of an access agreement for a half hour is determined by applying the following formula:

$$RIC = RNA \times RIF \times \frac{1}{100}$$

where —

RIC (in \$) is the half hourly residual imbalance charge in respect of the access agreement for the half hour;

RNA (in kWh) means the user’s residual imbalance.

RIF (in ¢/kWh) is —

- (a) if RNA is negative, then the half hourly residual imbalance (top-up) fee set out in the residual imbalance tariff list applicable to the half hour; or
- (b) if RNA is positive, then the half hourly residual imbalance (spill) fee set out in the residual imbalance tariff list applicable to the half hour.

- (4) If the sum of the half hourly residual imbalance charges for the half hours in a month is negative, then an amount equal to ? 1 multiplied by that sum is payable by the user to Western Power, except if the user is Western Power.
- (5) If the sum for the half hourly residual imbalance charges for the half hours in a month is positive, then an amount equal to that sum is payable by Western Power to the user, except if the user is Western Power.

23. Excess standby generation charge

- (1) In this regulation —
- (a) the “**demand exit rate**” for the group of connections in respect of a user’s access agreement for a half hour is determined by applying the following formula:

$$DERA = \sum_{i=1}^{i=n} (PTExit_i \times LFExit_i) + SUR$$

where —

DERA (in kW) is the demand exit rate for the group of connections in respect of the access agreement for the half hour;

PTExit_i (in kW) is the average rate at which electricity is transferred at exit point_i from the electricity transmission network during the half hour under the access agreement;

LFExit_i (a rate) is the loss factor for exit point_i determined under regulation 20;

the variable “i” represents an exit point which is one of the group of connections;

the variable “n” represents the number of exit points in the group of connections;

“SUR” means (in kW) the rate at which the user is transferring trading spill electricity to Western Power during the half hour.

- (b) the “**demand entry rate**” for the group of connections in respect of an access agreement for a half hour is determined by applying the following formula:

$$DER = \sum_{j=1}^{j=n} (PTEnter_j \times LFEnter_j) + TUR$$

where —

DER (in kW) is the demand entry rate for the group of connections in respect of the access agreement for the half hour;

PT_{Entry_j} (in kW) is the average rate at which electricity is transferred at entry point j to the electricity transmission network during the half hour under the access agreement;

LF_{Entry_j} (a rate) is the loss factor for entry point j determined under regulation 20;

the variable “ j ” represents an entry point which is one of the group of connections;

the variable “ n ” represents the number of entry points in the group of connections;

“TUR” means (in kW) the rate at which Western Power is transferring trading top-up electricity to the user during the half hour.

- (c) the “**standby generation reservation**” (in kW) for a group of connections is the aggregate rate at which Western Power may be required to transfer standby power to the connections in the group of connections under the access agreement;
- (d) the “**excess demand**” (in kW) in respect of a group of connections for a half hour is equal to —
- (i) the demand exit rate for the group of connections for the half hour;
- minus
- (ii) the demand entry rate for the group of connections for the half hour;
- minus
- (iii) the standby generation reservation for the group of connections for the half hour,
- but if the result of this calculation is negative, then the excess demand in respect of the group of connections for the half hour is zero;
- (e) if the excess demand in respect of a group of connections for a half hour is not zero, then an excess demand period in respect of the group of connections commences at the start of that half hour, except if that half hour already falls within an excess demand period in respect of the group of connections;
- (f) each excess demand period in respect of a group of connections includes 336 half hours.
- (2) If an excess demand period in respect of a group of connections in respect of a user’s access agreement commences during a month, then the excess standby generation capacity charge payable by the user in respect of the

group of connections for the month is determined by applying the following formula:

$$ESCC = \sum_{i=1}^{i=n} (E_i \times ESGF)$$

where —

ESCC (in \$) is the excess standby generation capacity charge in respect of the group of connections for the month;

E_i (in kW) is the highest excess demand in respect of the group of connections for any half hour falling within excess demand period i ;

ESGF (in \$/kW) is the excess standby generation capacity fee set out in the fee schedule for the financial year in which the month falls;

the variable “ i ” represents an excess demand period in respect of the group of connections that commenced during the month;

the variable “ n ” represents the number of excess demand periods in respect of the group of connections that commenced during the month.

24. Excess network usage charge

- (1) In this subregulation and subregulation (2) —
 - (a) the “**excess amount**” in respect of an entry point for a half hour is equal to —
 - (i) the average aggregate rate (in kW) at which the generating units connected at the entry point transferred electricity to the electricity transmission *network* during that half hour;

minus
 - (ii) the aggregate of the declared sent? out capacity figures (in kW) for those generating units,

but if the result of this calculation is negative, then the excess amount in respect of the entry point for the half hour is zero;
 - (b) if the excess amount in respect of an entry point for a half hour is more than zero, then an excess period in respect of the entry point commences at the start of that half hour, except if that half hour already falls within an excess period in respect of the entry point; and
 - (c) each excess period in respect of an entry point includes 336 half hours.
- (2) If an excess period in respect of a user’s entry point commences during a month, then the excess network usage charge payable by the user in respect

of the entry point for the month is determined by applying the following formula:

$$\text{ENUC} = \sum_{i=1}^{i=n} (\text{E}_i \times \text{USF} \times \text{EF})$$

where —

ENUC (in \$) is the excess *network* usage charge in respect of the entry point for the month;

E_i (in kW) is the highest excess amount for any of the half hours which fall within excess period_i;

USF (in \$/kW) is the use of system fee in respect of the entry point determined in accordance with the user's access agreement;

EF (a rate) is the excess *network* usage factor set out in the fee schedule for the financial year in which the month falls;

the variable "i" represents an excess period in respect of the entry point which commences during the month;

the variable "n" represents the number of excess periods in respect of the entry point which commence during the month.

- (3) In this subregulation and subregulation (4) —
- (a) the "**excess rate**" in respect of an exit point for a half hour is equal to —
- (i) the average rate (in kW) at which electricity is transferred from the electricity transmission network at the exit point during that half hour;
- minus
- (ii) the contract maximum demand for the exit point,
- but, if the result of this calculation is negative, then the excess rate in respect of the exit point for the half hour is zero;
- (b) if the excess rate in respect of an exit point for a half hour is more than zero, then an excess demand period in respect of the exit point commences at the start of that half hour, except if that half hour already falls within an excess demand period in respect of the exit point; and
- (c) each excess demand period in respect of an exit point includes 336 half hours.
- (4) If an excess demand period in respect of a user's exit point commences during a month, then the excess *network* usage charge payable by the user in

respect of the exit point for the month is determined by applying the following formula:

$$\text{ENUC} = \sum_{i=1}^{i=n} (E_i \times (\text{USF} + \text{CSF}) \times \text{EF})$$

where —

ENUC (in \$) is the excess network usage charge in respect of the exit point for the month;

E_i (in kW) is the highest excess rate for any of the half hours which fall within excess demand period i ;

USF (in \$/kW) is the use of system fee in respect of the exit point determined in accordance with the user's access agreement;

CSF (in \$/kW) is the common service fee determined in accordance with the user's access agreement;

EF (a rate) is the excess network usage factor set out in the fee schedule for the financial year in which the month falls;

the variable " i " represents an excess demand period in respect of the exit point which commences during the month;

the variable " n " represents the number of excess demand periods in respect of the exit point which commence during the month.

25. Other consequences of being out of balance

- (1) For the purposes of this regulation, a user is materially out of balance in respect of an access agreement for a half hour if its residual imbalance is not zero.
- (2) If Western Power becomes aware that —
 - (a) a user is materially out of balance in respect of one of its access agreements for a period; and
 - (b) as a result, the operation of the electricity transmission network or the electricity distribution network as defined in the Electricity Distribution Regulations 1997 is likely to be materially adversely affected or persons with electrical installations connected to the electricity transmission network or the electricity distribution network as defined in the Electricity Distribution Regulations 1997 are likely to be materially adversely affected,

then, subject to subregulation (3), Western Power may interrupt or curtail the transfer of electricity to or from one or more of the group of connections in respect of that access agreement in order to remove or reduce that material adverse effect.

Appendix 8

- (3) Western Power must give notice to a user of its intention to exercise its powers under subregulation (2) in relation to a connection of the user a reasonable time before doing so.
- (4) This regulation does not limit regulations 29 or 30 of the *ETR*.

”

Appendix 8: Appendix 4 – Modified EDR balancing provisions

See rule 3.42.

The provisions referred to in rule 3.42 are as follows:

“23. Interpretation of regulations 24, 25 and 27

In this regulation and regulations 24, 25 and 27 —

- (a) the “**group of connections**” in respect of a user’s distribution access agreement consists of —
 - (i) the entry points and exit points specified in the distribution access agreement and any linked transmission agreement in respect of the distribution access agreement; and
 - (ii) the entry points from which standby power is being supplied to one or more of those connections; and
- (b) rules 3.7 and 3.8 apply in respect of spill electricity and top-up electricity respectively.

24. Balancing

- (1) A user (other than Western Power) must use reasonable endeavours to ensure that its residual imbalance for that half hour is zero.
- (1a) The half hourly residual imbalance charge for a half hour in respect of a distribution access agreement —
 - (a) that relates to a regional power system, is to be determined in accordance with the methodology set out in the Prices and Charges Paper, and any relevant provisions of the Distribution Technical Code; and
 - (b) that relates to the interconnected network, is to be determined in accordance with subregulations (2) to (9).
- (3) The half hourly residual imbalance charge in respect of a distribution access agreement for a half hour is determined by applying the following formula:

$$RIC = RNA \times RIF \times \frac{1}{100}$$

RIC (in \$) is the half hourly residual imbalance charge in respect of the distribution access agreement for the half hour;

RNA (in kWh) means the user’s residual imbalance.

RIF (in ¢/kWh) is —

- (a) if RNA is negative, then the half hourly residual imbalance (top-up) fee set out in the residual imbalance tariff list applicable to the half hour; or
 - (b) if RNA is positive, then the half hourly residual imbalance (spill) fee set out in the residual imbalance tariff list applicable to the half hour.
- (4) If the sum of the half hourly residual imbalance charges for the half hours in a month is negative, then an amount equal to ? 1 multiplied by that sum is payable by the user to Western Power, except if the user is Western Power.
- (5) If the sum of the half hourly residual imbalance charges for the half hours in a month is positive, then an amount equal to that sum is payable by Western Power to the user, except if the user is Western Power.

25. Excess standby generation charge

- (1) In this regulation —
- (a) the “**demand exit rate**” for the group of connections in respect of a user’s distribution access agreement for a half hour is determined by applying the following formula:

$$\text{DERA} = \sum_{i=1}^{i=n} (\text{PTE}_{\text{Exit}_i} \times \text{LFE}_{\text{Exit}_i} \times \text{LFTX}_{\text{Exit}_i}) + \text{SUR}$$

where —

DERA (in kW) is the demand exit rate for the group of connections in respect of the distribution access agreement for the half hour;

$\text{PTE}_{\text{Exit}_i}$ (in kW) is the average rate at which electricity is transferred at exit point i from the electricity distribution network or the electricity transmission network (as the case requires) during the half hour under the distribution access agreement or any linked transmission agreement in respect of the distribution access agreement;

$\text{LFE}_{\text{Exit}_i}$ (a rate) is —

- (i) if exit point i is a transmission connection, then 1; and
- (ii) if exit point i is a distribution connection, then the loss factor for exit point i determined under regulation 22;

$\text{LFX}_{\text{Exit}_i}$ (a rate) is —

- (i) if exit point i is a transmission connection, then the loss factor determined under regulation 20 of the Electricity Transmission Regulations 1996 in respect of exit point i ; and

- (ii) if exit point *i* is a distribution connection, then the loss factor determined under regulation 20 of the Electricity Transmission Regulations 1996 in respect of the transfer point supplying exit point *i*;

the variable “*i*” represents an exit point which is one of the group of connections;

the variable “*n*” represents the number of exit points in the group of connections; and

“SUR” means (in kW) the rate at which the user is transferring trading spill electricity to Western Power during the half hour.

- (b) the “**demand entry rate**” for the group of connections in respect of a distribution access agreement for a half hour is determined by applying the following formula:

$$\text{DER} = \sum_{j=1}^{j=n} (\text{PTEnter}_j \times \text{LFEntry}_j \times \text{LFTXEntry}_j) + \text{TUR}$$

where —

DER (in kW) is the demand entry rate for the group of connections in respect of the distribution access agreement for the half hour;

PTEnter_{*j*} (in kW) is the average rate at which electricity is transferred at entry point *j* to the electricity distribution network or the electricity transmission network (as the case requires) during the half hour under the distribution access agreement or any linked transmission agreement in respect of the distribution access agreement;

LFEntry_{*j*} (a rate) is —

- (i) if entry point *j* is a transmission connection, then 1; and
- (ii) if entry point *j* is a distribution connection, then the loss factor for entry point *j* determined under regulation 22;

LFTXEntry_{*j*} (a rate) is —

- (i) if entry point *j* is a transmission connection, then the loss factor determined under regulation 20 of the Electricity Transmission Regulations 1996 in respect of entry point *j*; and
- (ii) if entry point *j* is a distribution connection, then the loss factor determined under regulation 20 of the Electricity Transmission Regulations 1996 in respect of the transfer point supplying entry point *j*;

the variable “j” represents an entry point which is one of the group of connections; and

the variable “n” represents the number of entry points in the group of connections;

“TUR” means (in kW) the rate at which Western Power is transferring trading top-up electricity to the user during the half hour.

- (c) the “**standby generation reservation**” (in kW) for a group of connections is the aggregate rate at which the market service provider may be required to transport standby power to the connections in the group of connections under the distribution access agreement or any linked transmission agreement;
- (d) the “**excess demand**” (in kW) in respect of a group of connections for a half hour is equal to —
- (i) the demand exit rate for the group of connections for the half hour;
- minus
- (ii) the demand entry rate for the group of connections for the half hour;
- minus
- (iii) the standby generation reservation for the group of connections for the half hour,
- but if the result of this calculation is negative, then the excess demand in respect of the group of connections for the half hour is zero;
- (e) if the excess demand in respect of a group of connections for a half hour is not zero, then an excess demand period in respect of the group of connections commences at the start of that half hour, except if that half hour already falls within an excess demand period in respect of the group of connections; and
- (f) each excess demand period in respect of a group of connections includes 336 half hours.
- (2) If an excess demand period in respect of a group of connections in respect of a user’s distribution access agreement commences during a month, then the excess standby generation capacity charge payable by the user in respect of the group of connections for the month is determined by applying the following formula:

$$ESCC = \sum_{i=1}^{i=n} (E_i \times ESGF)$$

where —

ESCC (in \$) is the excess standby generation capacity charge in respect of the group of connections for the month;

E_i (in kW) is the highest excess demand in respect of the group of connections for any half hour falling within excess demand period i ;

ESGF (in \$/kW) is the excess standby generation capacity fee set out in the transmission fee schedule for the financial year in which the month falls;

the variable “ i ” represents an excess demand period in respect of the group of connections that commenced during the month;

the variable “ n ” represents the number of excess demand periods in respect of the group of connections that commenced during the month.

26. Excess network usage charge

- (1) In this subregulation and subregulation (2) —
 - (a) the “**excess amount**” in respect of a distribution entry point for a half hour is equal to —
 - (i) the average aggregate rate (in kW) at which the generating units connected at the distribution entry point transferred electricity to the electricity distribution network during that half hour;

minus
 - (ii) the declared sent-out capacity (in kW) for that entry point, but if the result of this calculation is negative, then the excess amount in respect of the entry point for the half hour is zero;
 - (b) if the excess amount in respect of a distribution entry point for a half hour is more than zero, then an excess period in respect of the distribution entry point commences at the start of that half hour, except if that half hour already falls within an excess period in respect of the distribution entry point; and
 - (c) each excess period in respect of a distribution entry point includes 336 half hours.
- (2) If an excess period in respect of a user’s distribution entry point commences during a month, then the excess network usage charge payable by the user in respect of the distribution entry point for the month is determined by applying the following formula:

$$EUNC = \sum_{i=1}^{i=n} \left(\frac{E_i}{DSC} \times UNC \times EF \right)$$

where —

EUNC (in \$) is the excess use of network charge in respect of the distribution entry point for the month;

E_i (in kW) is the highest excess amount for any of the half hours which fall within excess period i ;

DSC (in kW) is the declared sent? out capacity for that entry point;

UNC (in \$) is the use of network charge in respect of the distribution entry point for the month;

EF is the excess network usage factor set out in the distribution price list for the financial year in which the month falls;

the variable “ i ” represents an excess period in respect of the distribution entry point which commences during the month; and

the variable “ n ” represents the number of excess periods in respect of the distribution entry point which commence during the month.

- (3) In this subregulation and subregulation (4) —
- (a) the “**excess rate**” in respect of a distribution exit point for a half hour is equal to —
- (i) the average rate (in kW) at which electricity is transferred from the electricity distribution network at the distribution exit point during that half hour;
- minus
- (ii) the contract maximum demand for the distribution exit point, but if the result of this calculation is negative, then the excess rate in respect of the distribution exit point for the half hour is zero;
- (b) if the excess rate in respect of a distribution exit point for a half hour is more than zero, then an excess demand period in respect of the distribution exit point commences at the start of that half hour, except if that half hour already falls within an excess demand period in respect of the distribution exit point; and
- (c) each excess demand period in respect of a distribution exit point includes 336 half hours.
- (4) If an excess demand period in respect of a user’s distribution exit point commences during a month, then the excess network usage charge payable by the user in respect of the distribution exit point for the month is determined by applying the following formula:

$$EUNC = \sum_{i=1}^{i=n} \left(\frac{E_i}{CMD} \times UNC \times EF \right)$$

where —

EUNC (in \$) is the excess use of network charge in respect of the distribution exit point for the month;

E_i (in kW) is the highest excess rate for any of the half hours which fall within excess demand period i ;

CMD (in kW) is the contract maximum demand for the distribution exit point;

EF is the excess network usage factor set out in the distribution price list for the financial year in which the month falls;

UNC (in \$) is the use of *network* charge in respect of the distribution exit point for the month;

the variable “ i ” represents an excess demand period in respect of the distribution exit point which commences during the month; and

the variable “ n ” represents the number of excess demand periods in respect of the distribution exit point which commence during the month.

27. Other consequences of being out of balance

- (1) For the purposes of this regulation, a user is materially out of balance in respect of a distribution access agreement for a half hour if its residual imbalance is not zero.
- (2) If Western Power becomes aware that —
 - (a) a user (other than Western Power) is materially out of balance in respect of one of its distribution access agreements for a period; and
 - (b) as a result, the operation of the electricity distribution network or the electricity transmission network is likely to be materially adversely affected or persons with electrical installations connected to the electricity distribution network or the electricity transmission network are likely to be materially adversely affected,

then, subject to subregulation (3), the market service provider may interrupt or curtail the transfer of electricity to or from one or more of the group of connections in respect of that distribution access agreement in order to remove or reduce that material adverse effect.

- (3) Western Power must give notice to a user of its intention to exercise its powers under subregulation (2) in relation to a connection of the user a reasonable time before doing so.

Appendix 8

- (4) This regulation does not limit regulations 31 or 32 of the *EDR*.

“

Appendix 8: Appendix 5 – Operating Procedures

See rule 10.1.

Communications

- A5.1 All communications from a *member* (other than the *market service provider*) to the *market service provider*, and (subject to clause A5.2) all communications from the *market service provider* to another *member*, must:
- (a) be by email with an attachment containing the relevant information; and
 - (b) be in the format (as to both email and attachment) determined from time to time by the *market service provider* acting as a *reasonable and prudent person* and notified to all *members*; and
 - (c) be capable of being reduced to writing by being printed.
- A5.2 Communications of a general nature from the *market service provider* to other *members* may be posted on the *market service provider's* website, in which case each *member* must be notified of the posting by an email under clause A5.1.
- A5.3 The *market service provider* must *publish* templates for standard communication requirements including:
- (a) *nominations*; and
 - (b) *renominations*.
- A5.4 A *member* other than the *market service provider* must use the templates published under clause A5.3.
- A5.5 If email services are unavailable for any reason *members* must use other methods of communication, in the following priority:
- (a) facsimile services;
 - (b) telephone, in which case a written confirmation:
 - (i) must be provided within 48 hours of the verbal communication being made; and
 - (ii) must include the name of the staff member to whom the communication was made.
- A5.6 The *market service provider* must *publish* its contact details on its website.

Appendix 8

Line losses

A5.7 Where the *TUAS market rules* refer to an adjustment for *line losses*, the adjustment will be calculated in accordance with the *member's access contract* by the *market service provider* acting as a *reasonable and prudent person*.

High Price days

A5.8 The *market service provider* may declare a *high price day* if it determines as a *reasonable and prudent person* (including by undertaking system studies), the generation capacity (adjusted for planned and unplanned outages, standby requirements, spinning reserve, interruptible loads, must not run constraints, and forecast load) exceeds a safety margin set to the standard of a *reasonable and prudent person*.

Liquids Event

A5.9 The *market service provider* may declare a *liquids event* if more than 10MW of generating plant using this fuel is required to run in the absence of higher merit order plant.

A5.10 The *market service provider* as soon as practicable after each *liquids event* must give all other *members* a notice outlining the reasons for the *liquids event* and the periods affected by the *liquids event*.

Calculating band size for top-up trading bands

A5.11 For a *member*:

- (a) *top-up trading band 1* is the band from 0% up to and including 70% of the *member's maximum trading requirement for trading top-up electricity*; and
- (b) *top-up trading band 2* is the band from 70% up to and including 100% of the *member's maximum trading requirement for trading top-up electricity*.

Calculating band size for spill trading bands

A5.12 For a *member*:

- (a) *spill trading band 1* is the band from 0% up to and including 70% of the *member's maximum trading requirement for trading spill electricity*; and
- (b) *spill trading band 2* is the band from 70% up to and including 100% of the *member's maximum trading requirement for trading spill electricity*.

Forecast production data

A5.13 For the purposes of the definition of "**forecast production data**" a *member* must provide statistically based forecasts of annual electricity production from its plant as

Appendix 8

well as shorter-term forecasts, sufficient to enable the *member's balancing band*, and top-up and spill requirements to be determined.

A5.14 Where a *member* is not able to provide forecast production data, the average profile of the system for similar types of generation units may be used.

Appendix 8: Appendix 6 – Procedural rules for arbitration

See rule 8.6.

Application

- A6.1 This Appendix 6 applies if:
- (a) in accordance with the rules, the *market service provider* or a *member* notifies the *arbitrator* that a dispute exists; and
 - (b) notification of the dispute is not withdrawn in accordance with the rules.

Informality and expedition

- A6.2 Subject to the rules, proceedings must be conducted with as little formality and technicality, and with as much expedition, as the requirements of this Appendix 6 and Chapter 8, and a proper hearing and determination of a dispute, permit.
- A6.3 The *arbitrator* may from time to time make orders:
- (a) regulating the conduct of proceedings; and
 - (b) regulating parties' conduct in relation to proceedings,
- which are directed towards achieving the objective in clause A6.2.
- A6.4 The parties to a dispute must at all times conduct themselves in a manner which is directed towards achieving the objective in clause A6.2.
- A6.5 An order under clause A6.3 is not an award.

Arbitrator may request information

- A6.6 The *arbitrator* may request the Minister to give to the *arbitrator* any information in the Minister's possession that is relevant to the dispute.
- A6.7 The Minister is to give the *arbitrator* the information requested, whether or not it is confidential and whether or not it came into the Minister's possession for the purposes of the arbitration.
- A6.8 If the Minister gives the *arbitrator* information that is confidential:
- (a) the Minister is to identify the nature and extent of the confidentiality; and
 - (b) the *arbitrator* is to treat the information accordingly.

Hearing to be in private

- A6.9 Subject to clause A6.10, proceedings are to be heard in private.

Appendix 8

A6.10 If the parties agree, proceedings or part of the proceedings may be conducted in public.

A6.11 The *arbitrator* may give written directions as to the persons who may be present at proceedings that are conducted in private.

A6.12 In giving directions under clause A6.16, the *arbitrator* must have regard to the wishes of the parties and the need for commercial confidentiality.

Right to representation

A6.13 In proceedings under these rules, a party may appear in person or be represented by someone else.

Procedure

A6.14 In proceedings, the *arbitrator*:

- (a) is not bound by technicalities, legal forms or rules of evidence; and
- (b) must act as speedily as a proper consideration of the dispute allows, having regard to the need to carefully and quickly inquire into and investigate the dispute and all matters affecting the merits, and fair settlement, of the dispute; and
- (c) may gather information about any matter relevant to the dispute in any way the *arbitrator* thinks appropriate.

A6.15 The *arbitrator* may determine the periods that are reasonably necessary for the fair and adequate presentation of the respective cases of the parties in the arbitration hearing, and may require that the cases be presented within those periods.

A6.16 The *arbitrator* may require evidence or argument to be presented in writing, and may decide the matters on which the *arbitrator* will hear oral evidence or argument.

A6.17 The *arbitrator* may determine that proceedings are to be conducted by:

- (a) telephone; or
- (b) closed circuit television; or
- (c) any other means of communication.

Particular powers of *arbitrator*

A6.18 The *arbitrator* may do any of the following things for the purpose of determining a dispute:

- (a) give a direction in the course of, or for the purpose of, proceedings; and
- (b) hear and determine the proceedings in the absence of a party who has been given notice of the hearing; and

Appendix 8

- (c) sit at any place; and
- (d) adjourn to any time and place; and
- (e) refer any matter to an independent expert and accept the expert's report as evidence.

A6.19 The *arbitrator* may make an interim determination.

Determinations

A6.20 If the *arbitrator* makes a determination or interim determination it must:

- (a) make it in writing, signed by the *arbitrator*, and
- (b) include in the determination a statement of reasons for making the determination.

A6.21 If a determination of an *arbitrator* under this Appendix 6 contains:

- (a) a clerical mistake; or
- (b) an error arising from an accidental slip or omission; or
- (c) a material miscalculation of figures or a material mistake in the description of any person, thing or matter referred to in the determination; or
- (d) a defect in form,

the *arbitrator* may correct the determination or the Court, on the application of a party, may make an order correcting the determination.

Contempt

A6.22 A person must not do any act or thing in relation to the arbitration of a dispute that would be a contempt of court if the *arbitrator* were a court of record.

Disclosure of information

A6.23 The *arbitrator* may give an oral or written direction to a person not to divulge or communicate to anyone else specified information that was given to the person in the course of proceedings unless the person has the *arbitrator's* permission.

A6.24 A person must not contravene a direction given under clause A6.23.

Power to take evidence on oath or affirmation

A6.25 The *arbitrator* may take evidence on oath or affirmation and for that purpose the *arbitrator* may administer an oath or affirmation.

A6.26 The *arbitrator* may summon a person to appear before the *arbitrator* to give evidence and to produce such documents (if any) as are referred to in the summons.

Appendix 8

A6.27 The powers contained in clauses A6.25 and A6.26 may only be exercised for the purposes of arbitrating a dispute under the rules.

Failing to attend as a witness

A6.28 A person who is served with a summons to appear as a witness before the *arbitrator* must not, without reasonable excuse:

- (a) fail to attend as required by the summons; or
- (b) fail to appear and report himself or herself from day to day unless excused, or released from further attendance, by the *arbitrator*.

Failing to answer questions etc.

A6.29 A person appearing as a witness before the *arbitrator* must not, without reasonable excuse:

- (a) refuse or fail to be sworn or to make an affirmation; or
- (b) refuse or fail to answer a question that the person is required to answer by the *arbitrator*; or
- (c) refuse or fail to produce a document that he or she is required to produce by a summons served on it.

A6.30 The determination as to what is a reasonable excuse for the purposes A6.29 is solely in the discretion of the *arbitrator*.

A6.31 It is a reasonable excuse for the purposes of clause A6.30 for an individual to refuse or fail to answer a question or produce a document on the ground that the answer or the production of the document might tend to incriminate the individual or to expose the individual to a penalty.

A6.32 Clause A6.31 does not limit what is a reasonable excuse for the purposes of clause A6.30.

Intimidation etc.

A6.33 A person must not:

- (a) threaten, intimidate or coerce another person; or
- (b) cause or procure damage, loss or disadvantage to another person, because that other person:
- (c) proposes to produce, or has produced, documents to the *arbitrator*; or
- (d) proposes to appear, or has appeared, as a witness before the *arbitrator*.

Party may request arbitrator to treat material as confidential

A6.34 A party to an arbitration hearing may:

- (a) inform the *arbitrator* that, in the party's opinion, a specified part of a document contains confidential commercial information; and
- (b) request the *arbitrator* not to give a copy of that part to another party.

A6.35 On receiving the request, the *arbitrator* must:

- (a) inform the other party or parties that the request has been made and of the general nature of the matters to which the relevant part of the document relates; and
- (b) ask the other party or parties whether there is any objection to the *arbitrator* complying with the request.

A6.36 If there is an objection to the *arbitrator* complying with a request, the party objecting may inform the *arbitrator* of its objection and of the reasons for it.

A6.37 After considering:

- (a) a request;
 - (b) any objection; and
 - (c) any further submissions that a party has made in relation to the request,
- the *arbitrator* may make a determination:
- (d) to not give to the other party or parties a copy of so much of the document as contains confidential commercial information that the *arbitrator* thinks should not be given; or
 - (e) to give the other party or another specified party a copy of the whole, or part, of the part of the document that contains confidential information subject to a condition that the party give an undertaking not to disclose the information to another person except to the extent specified by the *arbitrator* and subject to such other conditions as the *arbitrator* determines.

A6.38 An action for damages lies against any person (other than the *arbitrator*) who discloses information that the *arbitrator* has determined is confidential commercial information under clause A6.37.

Costs

A6.39 The costs of proceedings, including the fees and costs of the *arbitrator*, are in the discretion of the *arbitrator* who may:

- (a) direct to and by whom and in what manner the whole or any part of those costs is to be paid;

Appendix 8

- (b) tax or settle the amount of costs to be so paid or any part of those costs;
- (c) award costs to be taxed or settled as between party and party or as between solicitor and client.

Appeal to Court

A6.40 A party may appeal to the Court, on a question of law, from a determination of an *arbitrator* under this Appendix 6.

A6.41 An appeal must be instituted:

- (a) not later than the 28th day after the day on which the decision is made or within such further period as the Court (whether before or after the end of that day) allows; and
- (b) in accordance with the relevant Rules of Court

A6.42 The Court may make an order staying or otherwise affecting the operation or implementation of the determination of the *arbitrator* that the Court thinks appropriate to secure the effectiveness of the hearing and determination of the appeal.

Copies of decisions to be given to the Minister

A6.43 Where the *arbitrator* is required to give a copy of a draft decision or final decision to the parties to a dispute, the *arbitrator* is to also give a copy of the decision to the Minister.

Effect of appointment of new arbitrator on evidence previously given and awards and determinations previously made.

A6.44 Where a new person takes over the functions of *arbitrator* in place of a previous *arbitrator* who has begun but not completed the hearing and determination of a dispute:

- (a) the new *arbitrator* may order the proceedings to be re-heard:
 - (i) in full, in which case all evidence heard by the previous *arbitrator* is to be disregarded by the new *arbitrator*, or
 - (ii) in part, in which case any evidence heard by the previous *arbitrator* during the parts of the proceedings which are re-heard is to be disregarded by the new *arbitrator*,
- (b) if no order is made under clause A6.44(a), then the proceedings are to continue as though the new *arbitrator* had been present from the commencement of the proceedings;
- (c) if an order is made under clause A6.44(a)(ii), then:
 - (i) the proceedings are to continue as though the new *arbitrator* had been present during the earlier proceedings; and

- (ii) the new *arbitrator* is to treat any evidence given, document produced or thing done in the course of the earlier proceedings in the same manner in all respects as if it had been given, produced or done in the course of the proceedings conducted by the new *arbitrator*;
- (d) any interim determination made in the course of the earlier proceedings is by force of this Appendix 6 to be taken to have been made by the new *arbitrator*; and
- (e) the new *arbitrator* may adopt and act on any determination of a matter made in the course of the earlier proceedings without applying his or her own judgment to the matter.

A6.45 In clause A6.44, “**earlier proceedings**” means the proceedings or parts of the proceedings which the new *arbitrator* does not order to be re-heard under clause A6.44(a)(ii).

Arbitrator may issue summons

A6.46 A summons issued by the *arbitrator* under A6.26:

- (a) requiring a person to appear as a witness before the *arbitrator*; or
- (b) requiring a person to appear before the *arbitrator* and to produce a document to the *arbitrator*.

A6.47 A summons must include:

- (a) the name and address of the person on whom the summons is to be served;
 - (b) if the summons is for the production of a document:
 - (i) a proper description of the document; and
 - (ii) if the document is to be produced by a person that is a corporation, the name and title of the appropriate officer of the corporation who is to attend and produce the document;
- and
- (c) the date, time, and place of the hearing of the *arbitrator* at which the person is required to attend and, where applicable, produce the document.

A6.48 The summons remains in force for a period specified in the summons or, if no period is specified, until the conclusion of the proceedings in relation to which the summons has been issued.

A6.49 The summons is to be taken to have been effectively served if:

- (a) a copy of the summons has been handed to the person to be served or, if service by that method is refused or obstructed or made impracticable, a copy

- of the summons has been placed as near as practicable to the person and the person has been informed of the nature of the summons; or
- (b) a copy of the summons has been delivered to a legal practitioner acting for the person to be served and the legal practitioner has endorsed on the summons a statement to the effect that the legal practitioner accepts service; or
 - (c) the person to be served is a corporation and a copy of the summons was served on the corporation in accordance with the *Corporations Act 2001* (Cth); or
 - (d) a copy of the summons was served in accordance with an agreement made between the parties as to:
 - (i) the place and method of service; and
 - (ii) the person on whom service may be effected;or
 - (e) an answer to the summons has been filed with the *arbitrator*; or
 - (f) the *arbitrator* is satisfied that the person to be served has received a copy of the summons.

Decision of the Arbitrator

A6.50 Unless the *arbitrator* has made a decision under rule 8.5, the *arbitrator* must require the parties to make submissions to the *arbitrator* regarding the dispute by a specified date.

A6.51 In making a decision under rule 8.7, the *arbitrator* must:

- (a) consider submissions received from the parties before the date specified by the *arbitrator* under clause A6.50;
- (b) after considering submissions received by the date specified by the *arbitrator* under clause A6.50, provide a draft decision to the parties and request submissions from the parties by a specified date;
- (c) consider submissions received from the parties before the date specified by the *arbitrator* under clause A6.51(b); and
- (d) after considering submissions received by the date specified by the *arbitrator* under clause A6.51(b) provide a final decision to the parties.

A6.52 The *arbitrator* may, but need not, by whatever means it considers appropriate seek written submissions from persons who are not parties to the dispute and take those submissions into account in making its decision under rule 8.7.

Appendix 8

A6.53 The *arbitrator* must provide a final decision under rule 8.7 within three months of requiring parties to make submissions under clause A6.50. The *arbitrator* must also ensure that there is a period of at least 14 days:

- (a) between requiring parties to make submissions under clause A6.50 and the last day for such submissions specified by the *arbitrator*; and
- (b) between providing a draft decision to the parties under clause A6.51(b) and the last day for submissions on the draft decision specified by the *arbitrator*.
- (c) in all other respects the timing for the taking of each of the steps set out in clause A6.51 is a matter for the *arbitrator* to determine.

A6.54 The *arbitrator* may increase the period of three months specified in clause A6.53 by periods of up to one month on one or more occasions provided it provides the parties (and each person who has made a written submission to the *arbitrator*) with a notice of the decision to increase the period.

A6.55 The *arbitrator* need not before making a decision under clause A6.51(b) issue a draft decision.

A6.56 The *market service provider* must comply with a decision of the *arbitrator* made under this Appendix 6 from the date specified by the *arbitrator*.